



Thank you for purchasing a Borla Performance Cat-Back™ Exhaust System.

Precision manufactured using aircraft quality T-304 stainless steel; this system is designed to endure years of heavy use. Installing a Borla Performance Exhaust System on your vehicle will eliminate the restrictive design of the stock exhaust, allowing your engine to discharge exhaust gas easier. The result is more horsepower and torque, longer engine life, and a distinctive throaty growl- all this, with easy bolt-on installation. These installation instructions have been written to help you in the installation of your Borla Performance Exhaust System. Please read it completely before installing your system.

This Borla Performance Cat-Back™ Exhaust System (Part number 140030) has been designed for the 2002-04 BMW Mini Cooper equipped with a 1.6L 4-cylinder engine.

Borla Performance Industries recommends that an exhaust shop or professional after market parts installer, who has all the necessary equipment, tools and experienced personnel needed for proper installation, should perform the installation of this system. However, if you decide to perform the installation, we recommend someone should help you. Ensure the installer uses all under car safety precautions including eye protection.

Please take time to read and understand the following...

By installing your Borla Performance Exhaust System, you indicate that you have read this document and you agree with the terms stated below.

It is the responsibility of the purchaser to follow all installation instruction guidelines and safety procedures supplied with your Borla Performance Exhaust System.

Borla Performance Industries assumes no responsibility for damages occurring from misuse, abuse, improper installation, improper operation, lack of responsible care, or all previously stated reasons resulting from incompatibility with other manufacturer's products and/or systems.

Included with your Borla Performance Exhaust System is a warranty card. Please read it carefully before you begin any work on your vehicle. If you should have any questions regarding our warranty policy, installation, or any other matter pertaining to your new Borla Performance Exhaust System, please give us a call at the number provided on the warranty card.

Borla Performance Cat-Back™ Bill of Materials

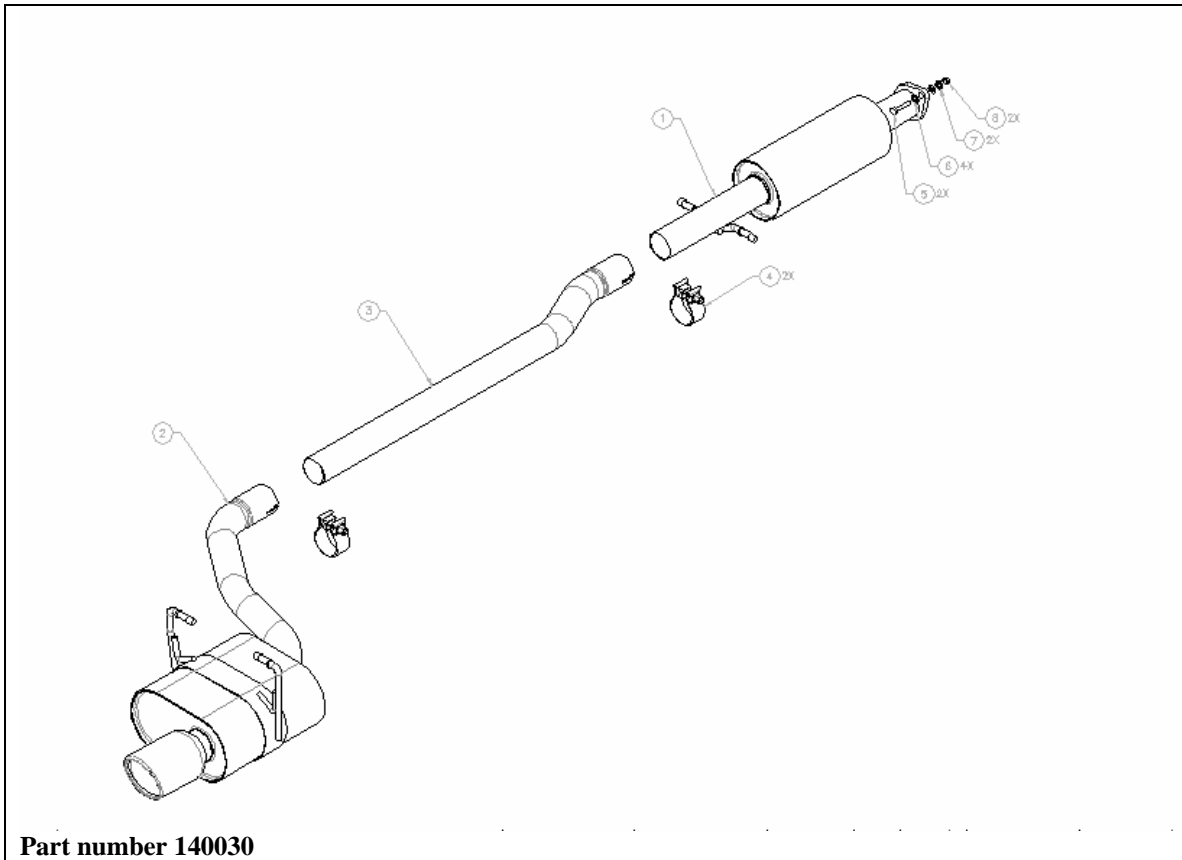

1. Front muffler assembly
2. Rear muffler assembly
3. Intermediate pipe
4. 2.25" Accuseal™ clamp (qty 2)
5. Hex head screw (qty 2)
6. Flat washer (qty 4)
7. Lock washer (qty 2)
8. Hex nut (qty 2)

Caution!!! Never work on a hot exhaust system. Serious injury in the form of burns can result If the vehicle has been in use and the exhaust system is hot, allow vehicle to cool for at least 1 hour. Always wear eye protection when working under any vehicle.

Note: It is our recommendation that you use a hoist or hydraulic lift to facilitate the installation of your new Borla Performance Cat-Back™ Exhaust System.

Taking all under car safety precautions, lift the vehicle using a hoist or hydraulic lift. Once this has been done, you may begin the removal of your old exhaust system from your vehicle.

Note: Before removing the original exhaust system from your vehicle, please compare the parts you have received with the bill of materials provided on the previous page to assure that you have all the parts necessary for the installation of your new Borla Performance Cat-Back™ Exhaust System.

Original Exhaust System Removal

Note: With a used vehicle, we suggest a penetrating spray lubricant to be applied liberally to all exhaust fasteners and allowing a significant period of time for the chemical to lubricate the threads before attempting to disassemble.

1. Unbolt flange shown in figure 1 just ahead of the front muffler assembly.
2. Lubricate all hangers and rubber brackets.
3. Using a muffler stand or an additional person to hold the exhaust system up in place, remove the 8 bolts that secure the support bracket shown in figure 2.

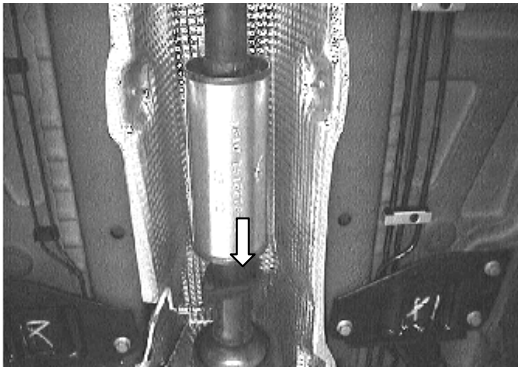

Figure 1

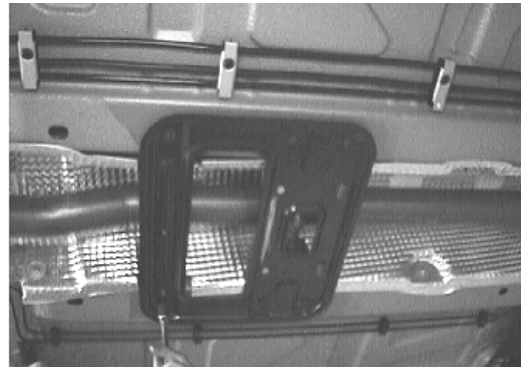

Figure 2

4. Unbolt the two rubber brackets such as the one shown in figure 3 on each side just above the rear muffler assembly.
5. Remove the exhaust from the vehicle.
6. Once system is removed, remove rubber hangers as shown in figure 4 from the front pipe assembly by unbolting them from the support bracket.
7. Remove the rubber hangers from the rear muffler assembly.

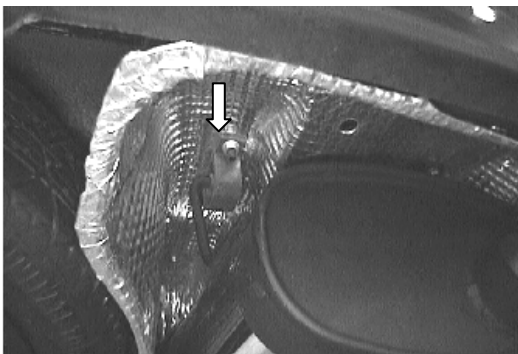

Figure 3

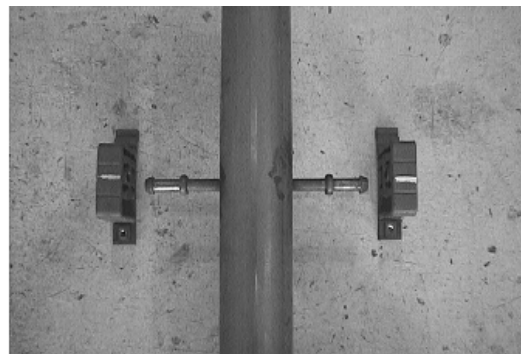

Figure 4

You are now ready for the installation of your Borla Performance Cat-Back™ Exhaust System.

Borla Performance Cat-Back™ Exhaust System Installation

Warning: Use extreme caution during installation. Torque all fasteners according to manufacturer's torque values and tightening sequence. **DO NOT** use air impact tools to tighten fasteners on Borla Performance Exhaust Systems. Use of such tools may result in bent flanges or gasket contact areas leading to exhaust leaks. If any welding is performed, protect vehicle brake, fuel, vacuum or similar lines. Always check for any damage after welding has been done. Also check inside vehicle for damage to such items as carpet, inner liner, etc. Always have a class C fire extinguisher and a bucket of water available during any welding process.

1. Assemble the front muffler assembly as shown in figure 5 by placing the rubber brackets on the hangers and installing them to the support bracket using the original hardware.
2. Place front muffler assembly in position as shown in figure 6. Bolt flanges together using the gasket and hardware supplied. Using the original hardware, secure the support bracket to the vehicle.



Figure 5



Figure 6

3. Place clamp on the expanded end of the intermediate pipe and install into position as shown in figure 7. **DO NOT** tighten the clamp.
4. Install rubber brackets as shown in figure 8 on the hangers of rear muffler assembly.

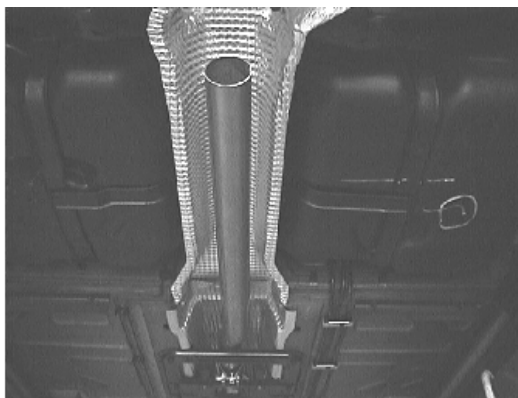

Figure 7

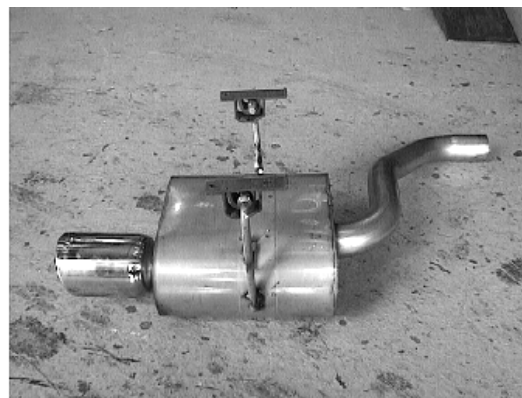

Figure 8

5. Place a clamp over the expanded end of the rear muffler assembly. Using a muffler stand or an additional person, hold rear muffler assembly into position shown in figure 9. Using the original hardware, secure the two rubber brackets to the vehicle.

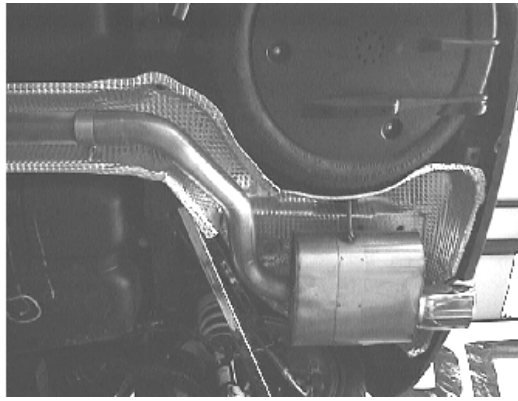

Figure 9

6. Align tip and tighten Accuseal™ clamps to 32-35 ft. lbs. working from the front of the vehicle to the rear.
7. Before starting your vehicle, make sure to check all wires, hoses, brake lines, body parts and tires for safe clearance from the exhaust system.
8. Start vehicle and check for any leaks. If any leaks are found, determine cause (such as loose or incorrectly positioned clamp) and repair as necessary.

Note: When you first start your vehicle after the installation of your new Borla Performance Exhaust System, there may be some smoke and fumes coming from the system. This is a protective oil based coating used in the manufacturing of mandrel bent performance exhaust tubing. This is not a problem and will disappear within a very short period of time after the exhaust has reached normal operating temperatures.



Congratulations!!! You have completed the installation of the world famous Borla Performance Stainless Steel Exhaust System.