



Installation instructions

Akrapovič Exhaust System:

Evolution EC type approved and **Evolution**
for the

Porsche Panamera (type 970)

Porsche Panamera 4 (type 970)

Porsche Panamera S (type 970)

Porsche Panamera 4S (type 970)

Porsche Panamera GTS (type 970)

Porsche Panamera Turbo (type 970)

Porsche Panamera Turbo S (type 970)



Installation instructions

Akrapovič Exhaust System:

Evolution EC type approved and **Evolution**

for the

Porsche Panamera (type 970)

Porsche Panamera 4 (type 970)

Porsche Panamera S (type 970)

Porsche Panamera 4S (type 970)

Porsche Panamera GTS (type 970)

Porsche Panamera Turbo (type 970)

Porsche Panamera Turbo S (type 970)

Congratulations on purchasing an Akrapovič exhaust system. Please read the entire installation manual prior to undertaking any activities related to installation of your new Akrapovič exhaust system. In case you do not fully understand the manual or any of its parts, please contact your authorized dealer!

This product should be installed by someone with sufficient knowledge of exhaust systems and their installation, and appropriate hand or power tools. If you are not qualified for this work, please utilize a certified mechanic for installation. By installing Your Akrapovič exhaust system, you indicate that you have read the installation manual in its entirety and you agree with the terms stated herein.

It is your responsibility to follow all installation instruction guidelines supplied with the Akrapovič exhaust system and undertake all necessary safety precautions. Akrapovič d.d. assumes no responsibility for damages occurring from misuse, abuse, improper installation, improper operation, lack of responsible care, or all previously stated reasons resulting from incompatibility with other manufacturer's products and/or systems.

IMPORTANT INFORMATION

Exclusion of Certain Liability

1. The manufacturer, importer or dealer shall not be liable for any incidental damage including personal injury or any other damages caused by improper installation or operation of the Akrapovič exhaust system. When installing the Akrapovič exhaust system be careful that the exhaust system does not touch other parts sensitive to high temperature.
2. Akrapovič makes no representation or warranties with regard to damage caused by the improper installation, use and maintenance of the Akrapovič exhaust system. The warranty is limited to defects recognized by our technical department and due to normal use, and excludes items subject to normal wear (gaskets and damping wool). The guarantee is void in case of accident, modification, improper or competition use.
3. Do not attempt to install the Akrapovič exhaust system on a vehicle model for which it was not made or tested by Akrapovič.
4. When the exhaust system gets very hot during operation, be careful not to burn yourself on the exhaust system or parts which are in direct contact with it, even when the engine is not running. Also protect other people, especially children, from the injuries mentioned above.

1. In some cases Akrapovič exhaust system kits contain chemical products (ceramic anti-seizing grease; bolt sealant). Handle with care, do not inhale or swallow. Avoid excessive contact with skin, eyes or mucous membranes. Keep out of reach of children.
2. Technical specifications of Akrapovič exhaust systems and related products are subject to change without notice.
3. Before removing the original exhaust system from your vehicle, please compare the parts you received with the list of materials provided in the installation manual in order to assure that you have all the parts necessary for the installation of your new Akrapovič exhaust system.
4. Although this manual consists of instructions for installation in written form, as well as photographs and pictures representing individual steps of the installation, please note that the photographs and pictures are symbolic and are intended for representation of general overview only. The photographs and pictures contained herein should serve as a guideline only and actual installation of the exhaust system may not correspond with the photographs and pictures entirely.
5. The process of uninstalling the original exhaust system may vary depending on the existing exhaust system. Please follow the original exhaust system manufacturer's instructions for uninstalling the original exhaust system.

Trademarks

The Akrapovič trademark, including corporate logos and emblems, are subject to copyright as well as trademark rights of Akrapovič, its licensors or third persons authorizing Akrapovič to use them.

Akrapovič website

Information about Akrapovič exhaust systems and related products is available on the Akrapovič website at:

<http://www.akrapovic.com/>

Copyright

No part of the Akrapovič exhaust system or its documentation may be reproduced or distributed in any form or by any means without the prior written authorization of the Akrapovič company.

© Akrapovič, d.d. All rights reserved.

Symbols

The following symbols are used throughout these installation instructions:



TOOLS REQUIRED



TIGHTENING TORQUE



INSTALLATION TIP



CAUTION OR WARNING



USE BOLT SEALANT; Apply 3 to 4 small drops of bolt sealant onto the cleaned and degreased threads before tightening the bolts. **WARNING! Avoid contact with skin, eyes and mucous membranes. Do not inhale fumes. Keep out of the reach of children.**



USE ANTI-SEIZE LEAD-FREE COPPER PASTE (black tube); Provides trouble-free and long-lasting protection against seizing, corrosion and rusting of bolts, threaded ends, nuts, joints, etc. Also protects against vibration, wear and impact. **WARNING! Avoid eye contact. Avoid excessive skin contact. Keep out of reach of children.**



USE ANTI-SEIZING GREASE (white tube); Prevents seizing, corrosion and excessive wear between the titanium components of your exhaust system. **WARNING! Avoid eye contact. Avoid excessive skin contact. Keep out of reach of children.**



T-handle 16mm wrench
T-handle 10mm wrench
Torx 25
Torx 27
Torx CTX40
Torx E12
Small screwdriver (slotted head)
Cutting nippers



BEFORE INSTALLING, CHECK SCHEMATIC OF THE EXHAUST SYSTEM! THE LATEST VERSION OF THE PARTS LIST AND SCHEMATIC DRAWINGS OF THE PRODUCTS ARE AVAILABLE ON OUR WEB PAGE.



IF ANY ITEMS IN THE AKRAPOVIČ EXHAUST SYSTEM PACKAGE ARE MISSING, PLEASE CONTACT YOUR AUTHORIZED DEALER. KEEP THE SCHEMATIC FOR FUTURE REFERENCE.



THESE INSTALLATION INSTRUCTIONS MUST BE READ CAREFULLY IN ORDER TO ENSURE PROPER INSTALLATION AND OPERATION OF THE AKRAPOVIČ EXHAUST SYSTEM.



THE EXHAUST SYSTEM CAN BE EXTREMELY HOT. ALLOW THE EXHAUST AND ENGINE TO COOL DOWN BEFORE BEGINNING INSTALLATION.



WE ADVISE YOU TO LEAVE INSTALLATION TO A QUALIFIED SERVICEMAN. IMPROPER INSTALLATION MAY RESULT IN A SHORTER LIFETIME OF THE EXHAUST SYSTEM AND/OR DAMAGE TO THE VEHICLE.



**IN THIS INSTALLATION INSTRUCTION MANUAL, DESCRIPTION OF VEHICLE MODELS REFERS TO:
PANAMERA V6/V8 - Panamera/Panamera 4/Panamera S/Panamera 4S/Panamera GTS
PANAMERA Turbo - Panamera Turbo/Panamera Turbo S**



WHEN INSTALLING AKRAPOVIČ'S AFTERMARKET OPTIONAL DOWN PIPES WITHOUT CATALYTIC CONVERTERS, WHICH ARE DEVELOPED FOR USE ON CLOSED TRACKS ONLY, REMAPPING OF THE ECU IS MANDATORY. THE AKRAPOVIČ COMPANY TAKES NO RESPONSIBILITY FOR ECU REMAPPING OR ANY POTENTIAL ISSUES RELATED TO THE USE OF AKRAPOVIČ DOWN PIPES.



AT EACH ENGINE START, THE EXUP VALVE MAY VIBRATE FOR A FEW SECONDS UNTIL THE VACUUM SYSTEM REACHES OPERATING PRESSURE.

REMOVAL OF ORIGINAL EXHAUST SYSTEM:

Put the vehicle onto a car lift.

! WARNING: make sure, that car lifting is safely and correctly done or you risk vehicle damage, injury or even death!

1. **For all vehicle models:** unscrew the marked bolts and nuts on both sides of the vehicle and remove the chassis panels off the vehicle (**Figure 1, 2, 3**).

! WARNING: make sure, that you don't injure yourself or damage any part of the vehicle during this procedure!

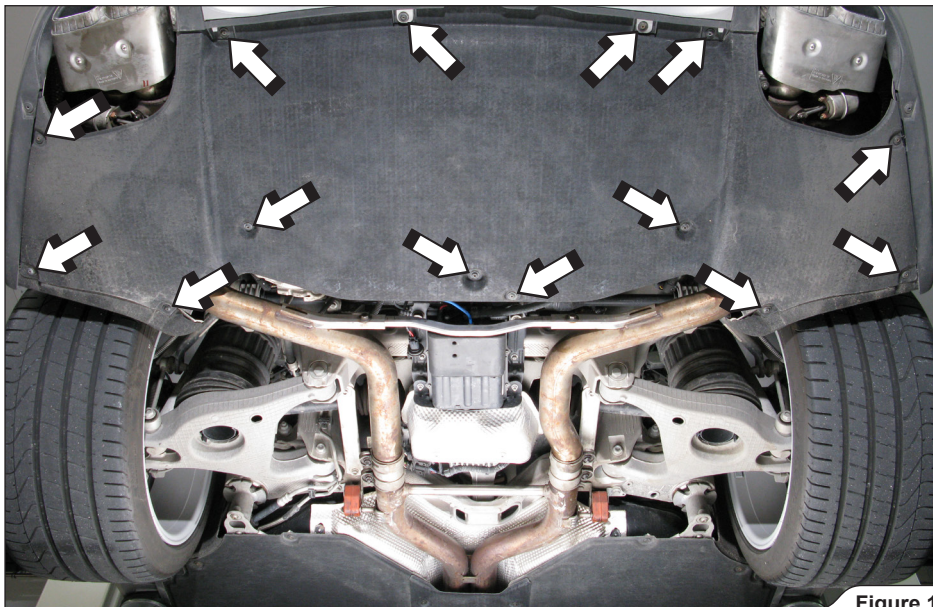

Figure 1

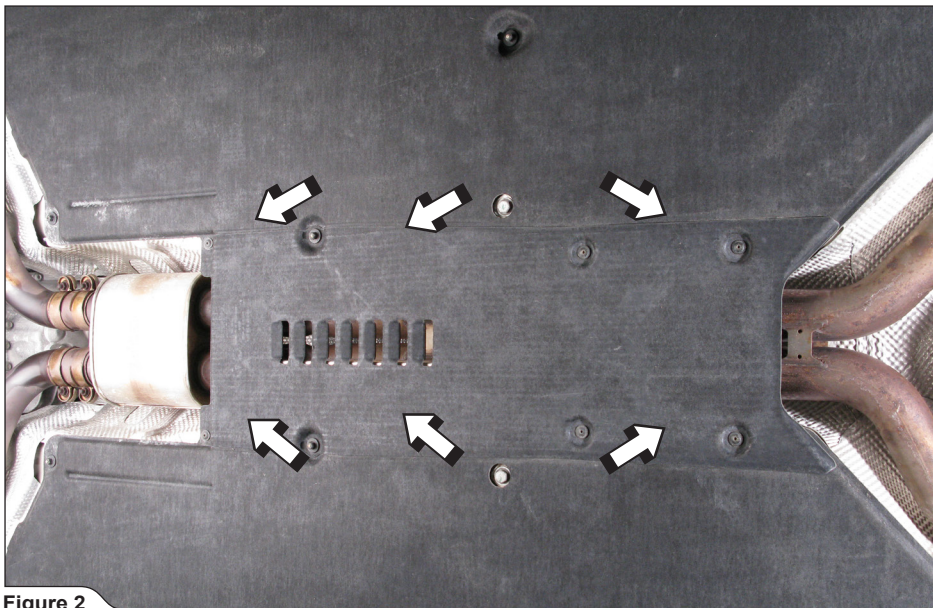

Figure 2

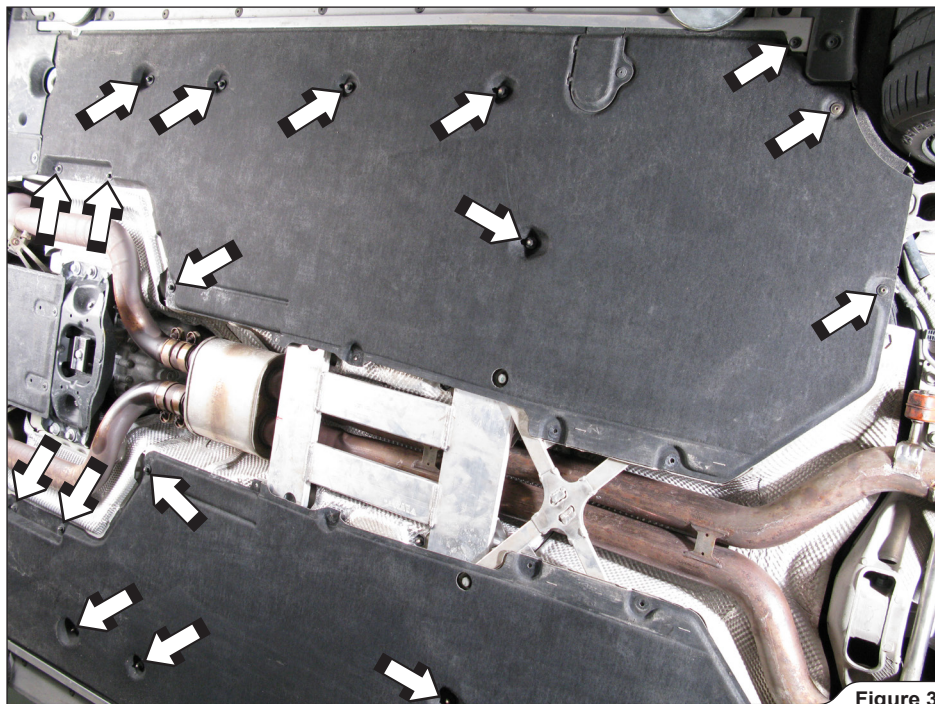

Figure 3

2. **For all vehicle models:** unscrew the marked bolts on both sides of the vehicle and remove both aluminium chassis reinforcements (**Figure 4**).

! **WARNING:** make sure, that you support the linkages during this process or you could injure yourself or damage the vehicle!

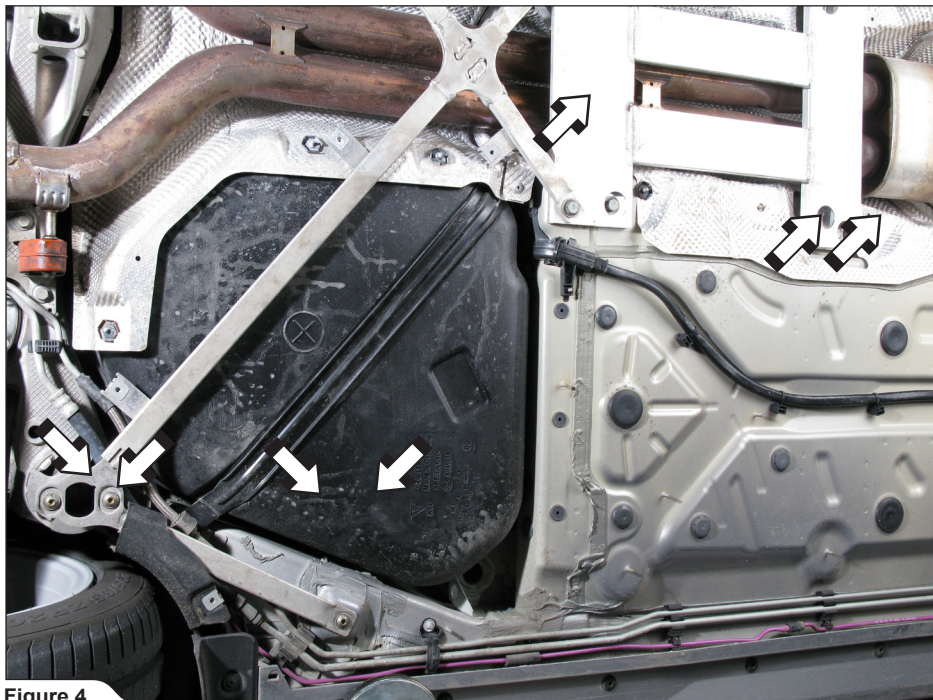

Figure 4

3. **For all vehicle models:** loosen the marked clamps' nuts and slide them off the pipes' joints (Figure 5).

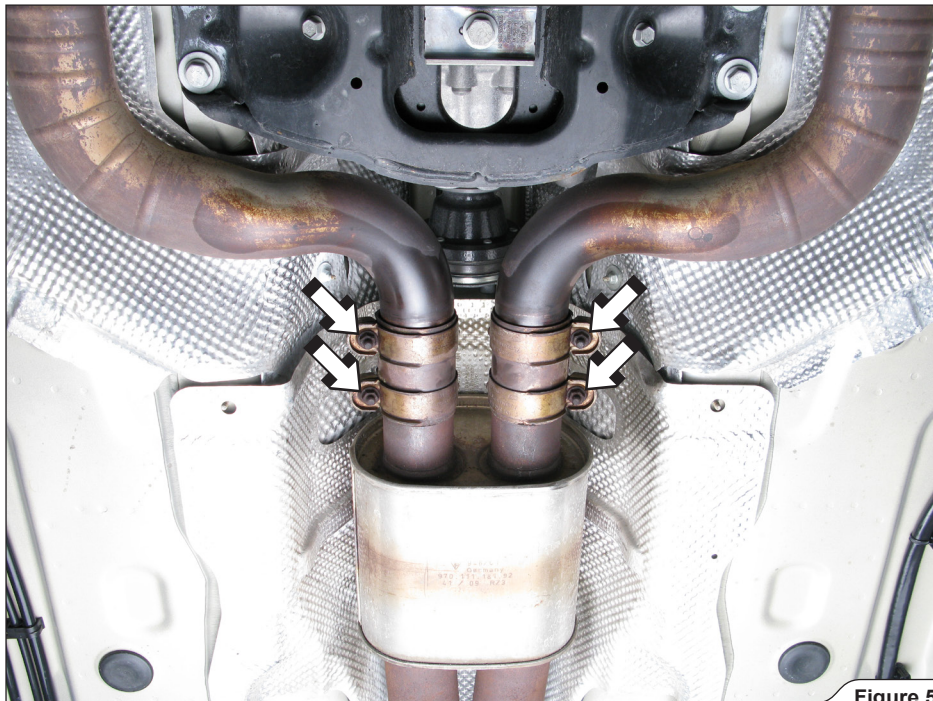

Figure 5

4. **For vehicle models equipped with original exhaust system flaps only:** pull the vacuum hoses off the vacuum actuators on both sides of the vehicle (Figure 6).

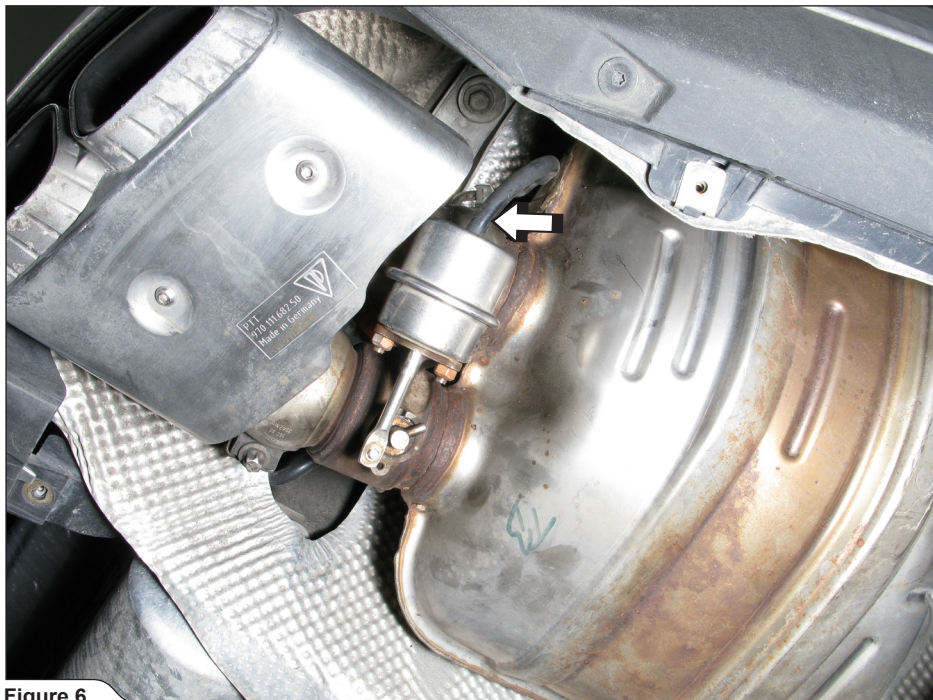

Figure 6

5. **For all vehicle models:** carefully pull the rubber brackets off the muffler's brackets on both sides and remove the original mufflers off the vehicle (**Figure 7**).

! **WARNING:** make sure, that you support the original exhaust during this process or you could injure yourself or damage the vehicle!

✂ **INSTALLATION TIP:** for easier dismounting, lubricate the rubber brackets (WD40).



Figure 7

6. **For all vehicle models:** carefully pull the rubber brackets off the link pipes' brackets and remove the original link pipes off the vehicle (**Figure 8**).

! **WARNING:** make sure, that you support the original exhaust during this process or you could injure yourself or damage the vehicle!

✂ **INSTALLATION TIP:** for easier dismounting, lubricate the rubber brackets (WD40).

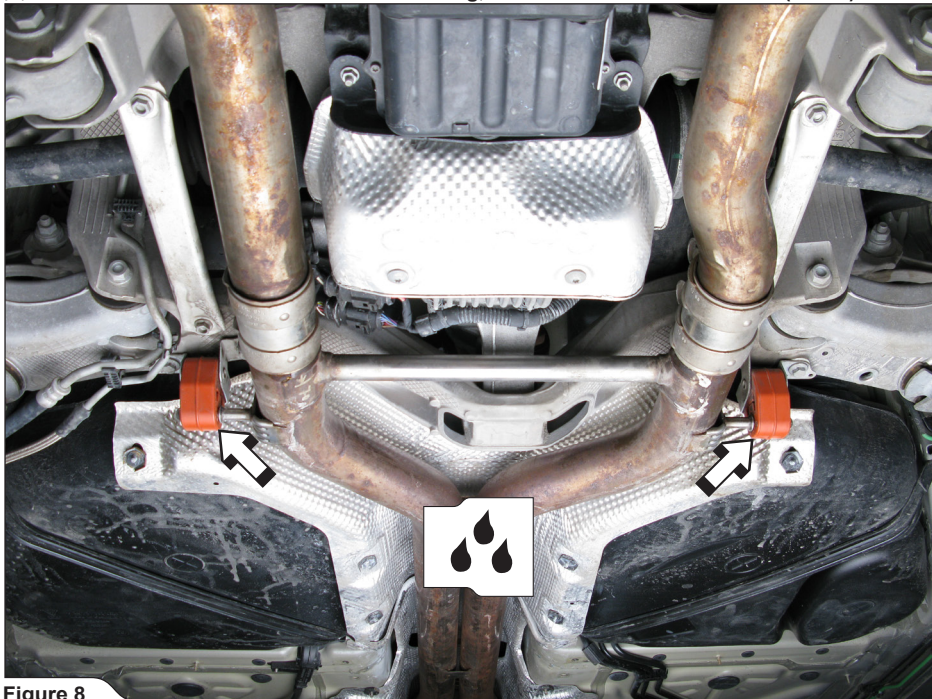

Figure 8

7. **For vehicle models equipped with original exhaust system flaps only:** remove the snap rings and unscrew the original vacuum actuators off the mufflers (Figure 9).



Figure 9

8. **For vehicle models equipped with original exhaust system flaps only:** remove the original rubber vacuum hoses off the metal vacuum pipes on both sides of the vehicle (**Figure 10, 11**).

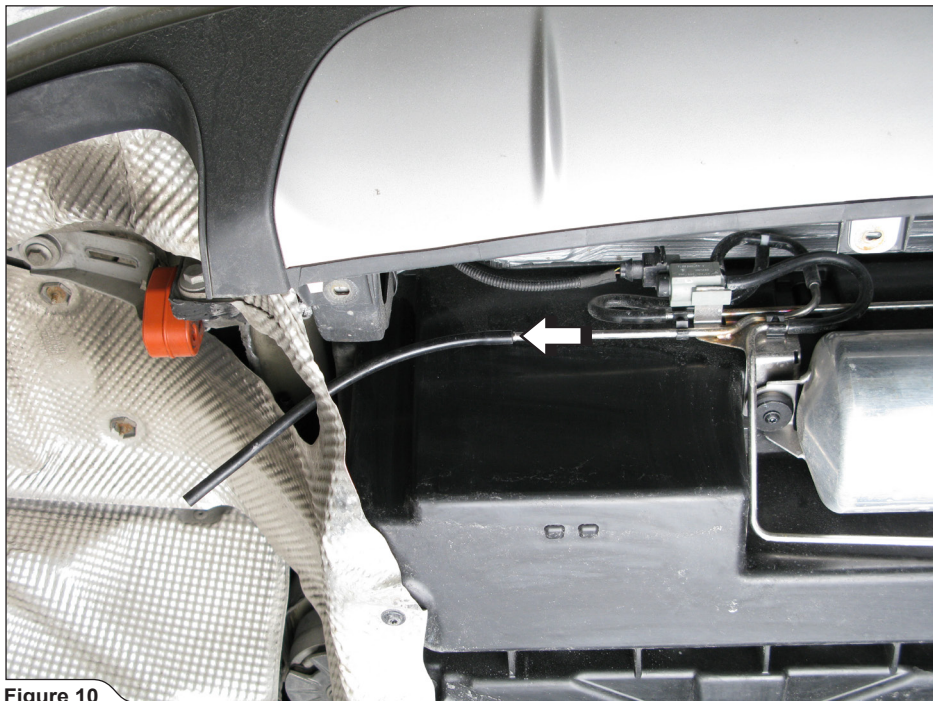

Figure 10



Figure 11

INSTALLATION OF THE AKRAPOVIČ EXHAUST SYSTEM:

1. **For vehicle models equipped with original exhaust system flaps only:** direct the vacuum rubber hoses from Akrapovič installation kit, exactly as shown (Figure 12, 13).
- !** **WARNING:** direct and secure the rubber vacuum hose in such a way, that it doesn't touch any hot or moving parts of the vehicle (Figure 12)!

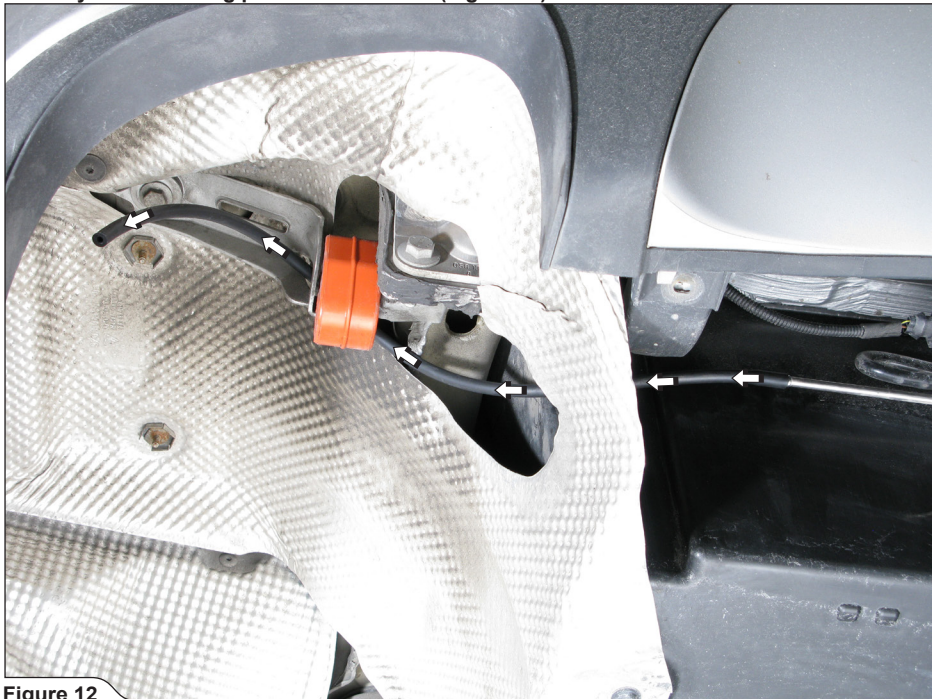

Figure 12

! **WARNING:** direct and secure the rubber vacuum hose in such a way, that it doesn't touch any hot or moving parts of the vehicle (Figure 13)!

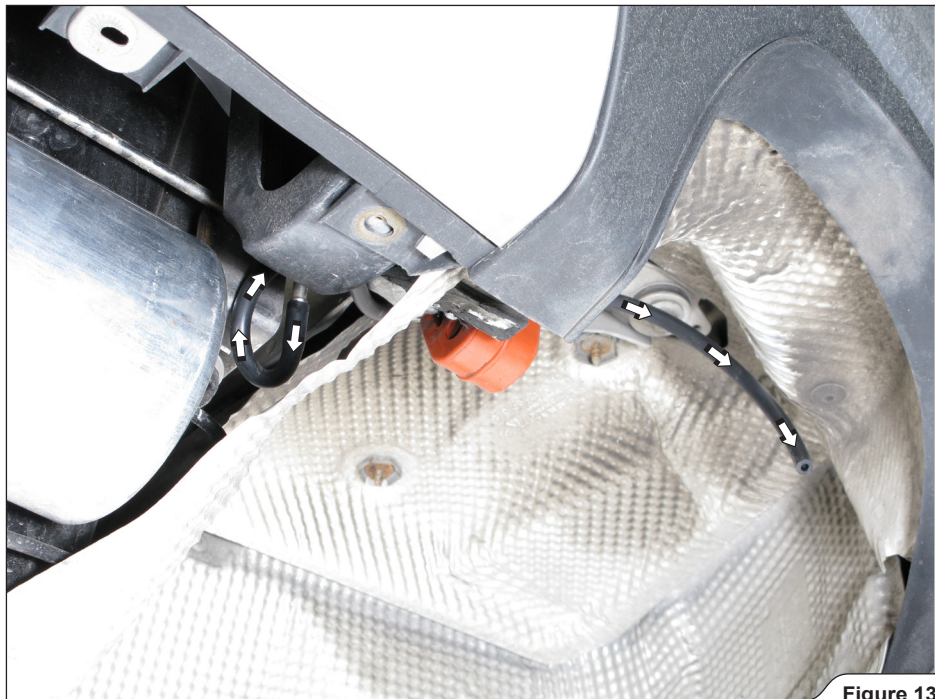

Figure 13

2. **For vehicle models equipped with original exhaust system flaps only:** assemble the original vacuum actuators onto Akrapovič exhaust valves, using original gaskets (between actuators and brackets), nuts and additional Akrapovič snap rings (**Evolution EC type approved: Figure 14; Evolution: Figure 15**).

! **WARNING:** make sure, that vacuum actuators close the valves all the way when deployed! Insert the additional suitable washers between actuators and actuator brackets, if necessary!

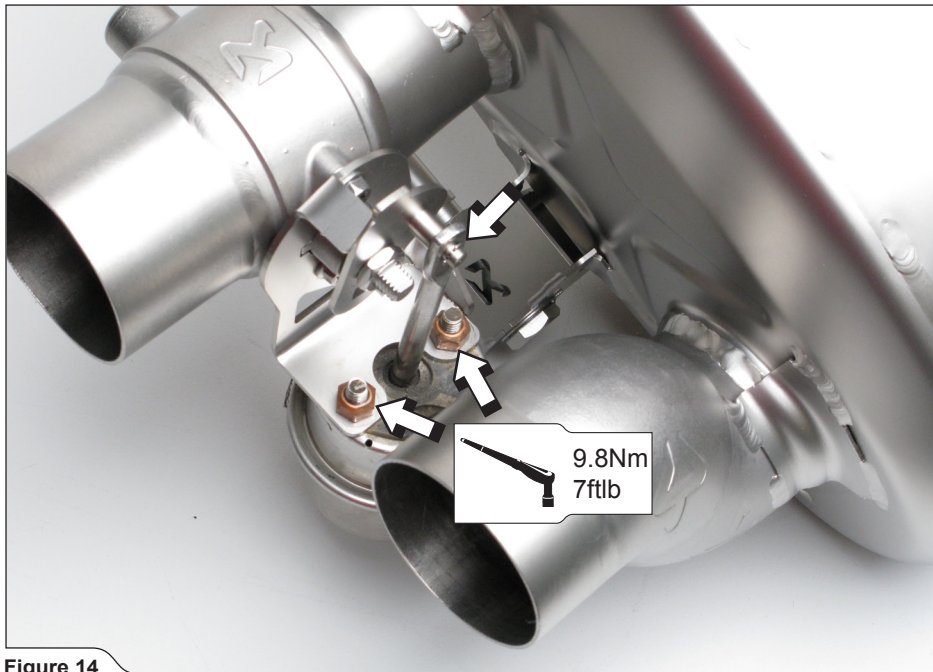

Figure 14

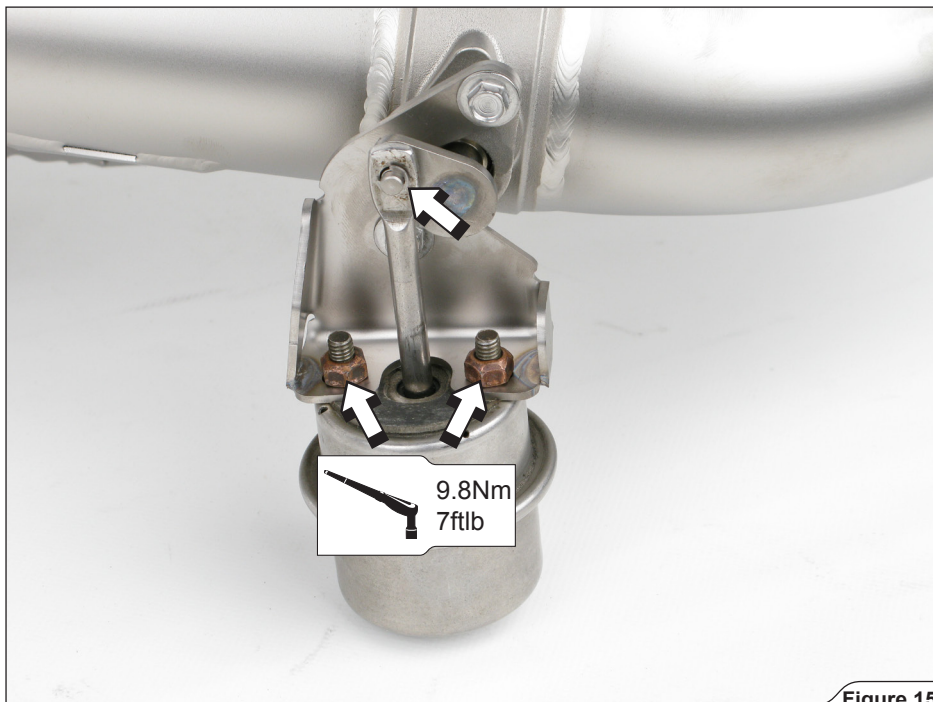

Figure 15

3. For V6 and V8-non turbo vehicle models with Akrapovič optional wireless kit only: assemble the Akrapovič actuators' brackets and vacuum actuators onto exhaust valves, using bolts, nuts, angular junctions and snap rings from Akrapovič installation kit (**Figure 16**).

! **WARNING:** make sure, that vacuum actuators close the valves all the way when deployed! Adjust the angular junctions, if necessary!

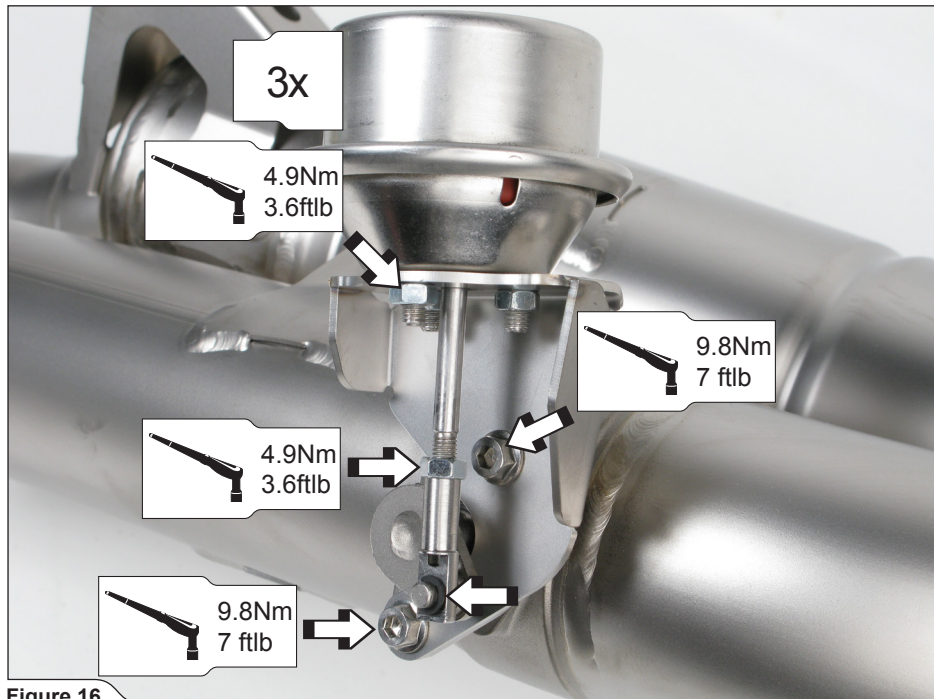

Figure 16

4. For V6 and V8-non turbo vehicle models without Akrapovič optional wireless kit only: **Closed position of the valves:** fixate the exhaust valves in the closed position, using brackets, bolts, nuts, springs, angular junctions and snap rings from Akrapovič installation kit (**Figure 17**).

! **WARNING:** make sure, that exhaust valves are under spring load and fully closed - adjust the angular junctions, if necessary!

! **CAUTION:** the length of compressed spring should not exceed 10mm.

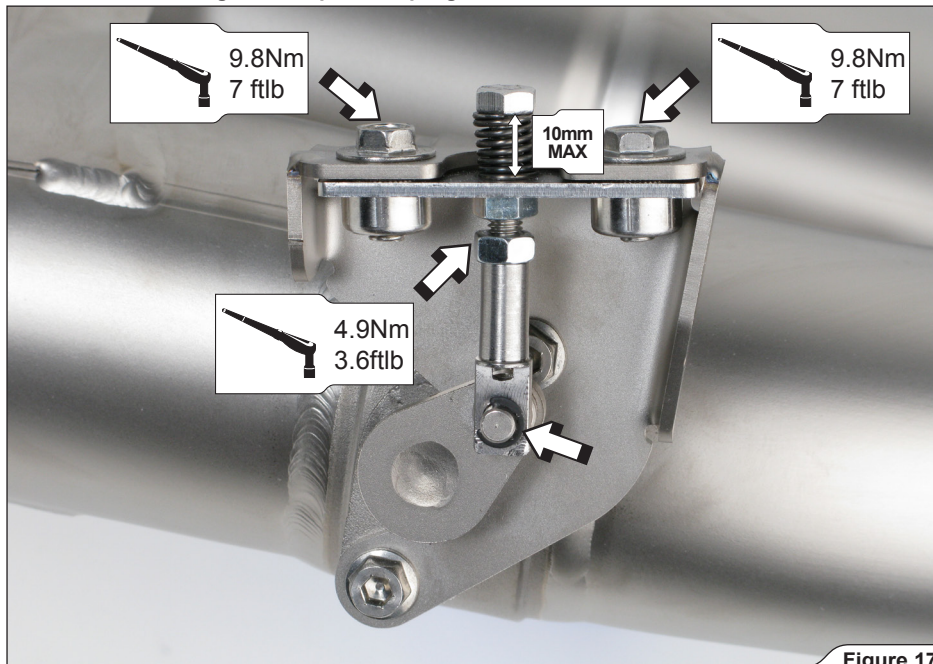

Figure 17

5. For V6 and V8-non turbo vehicle models with Akrapovič optional wireless kit only: **Opened position of the valves:** fixate the exhaust valves in the opened position, using brackets, bolts, nuts, springs, angular junctions and snap rings from Akrapovič installation kit (**Figure 18**).
- ! **WARNING:** make sure, that exhaust valves are under spring load and fully closed - adjust the angular junctions, if necessary!
- ! **CAUTION:** the length of compressed spring should not exceed 10mm.

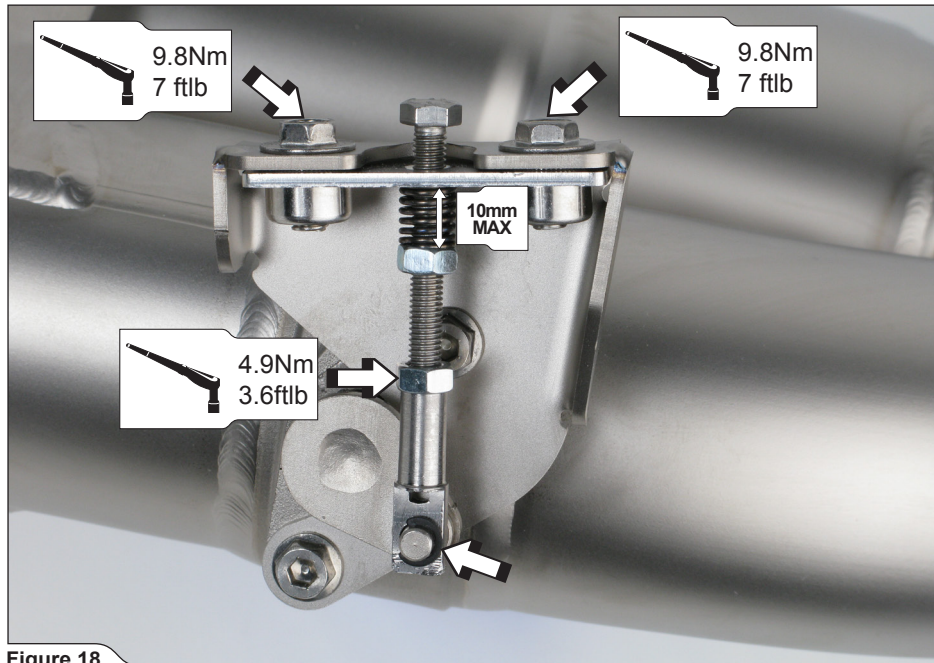

Figure 18

6. **For V6 and V8-non turbo vehicle models only:** assemble the adapters with clamps from Akrapovič installation kit, as shown (**Figure 19**).

! **WARNING:** use anti-seize copper paste on clamp bolt and nut threads!



Figure 19

7. **For V6 and V8-non turbo vehicle models only:** for easier centering of the adapters later, mark the original down pipes 45mm from the pipes' outlets and slide the adapters onto the original down pipes, as shown (Figure 20).

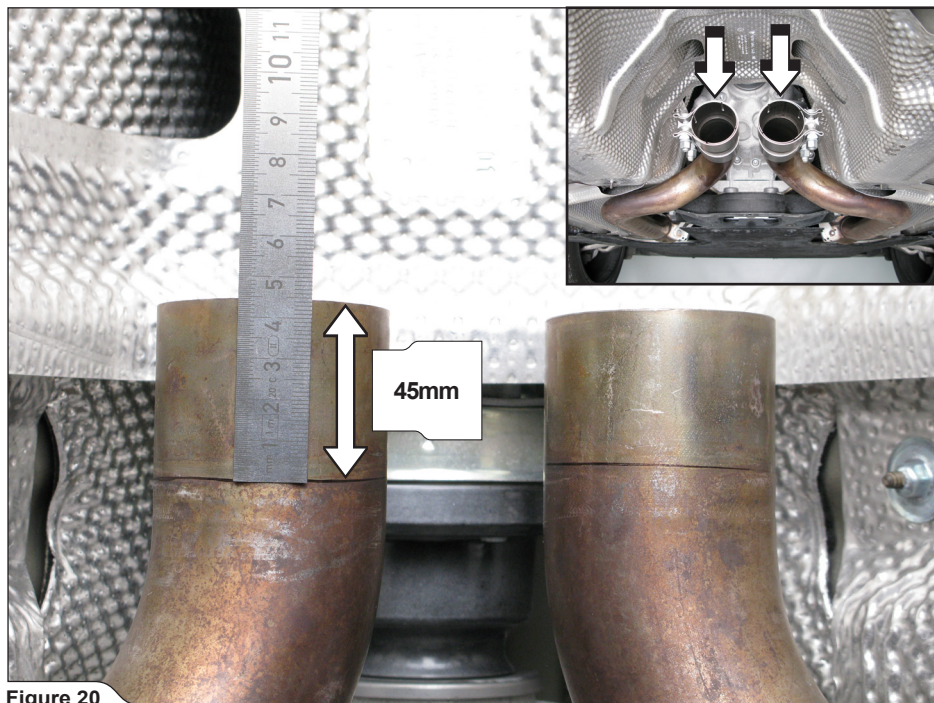

8. For all vehicle models: attach the link pipes onto the original rubber brackets (Figure 21).
✂ **INSTALLATION TIP:** for easier mounting, lubricate the rubber brackets (WD40).

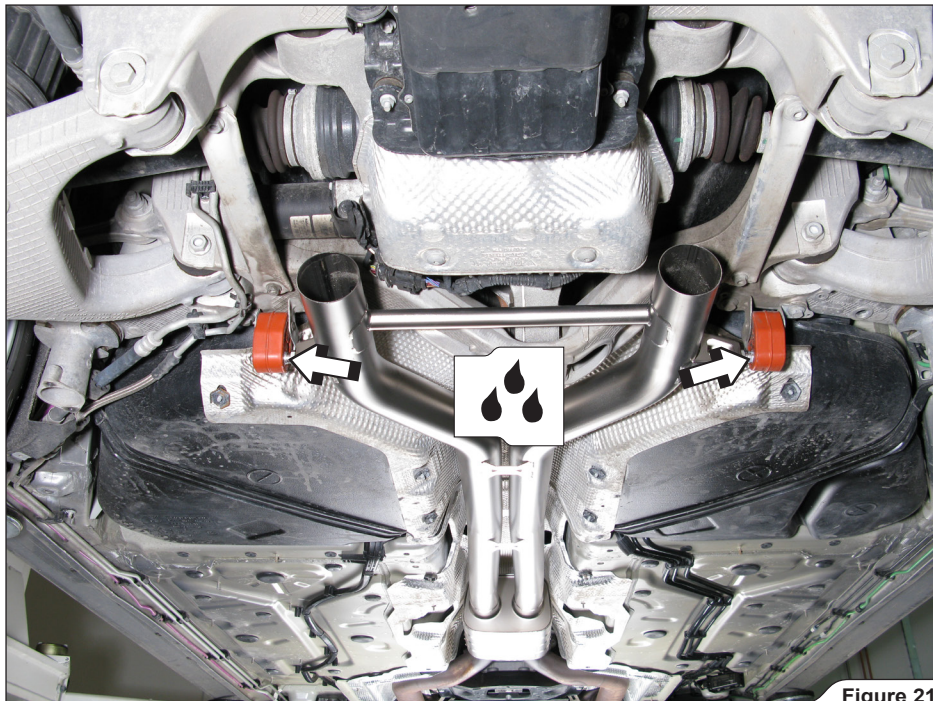

Figure 21

9. For V6 and V8-non turbo vehicle models only: join the Akrapovič link pipes and original front pipes, align the adapters with clamps on the middle of the joint and tighten the clamps to a specified torque (Figure 22).

✂ INSTALLATION TIP: for easier centering of the adapters, use the marks made before.

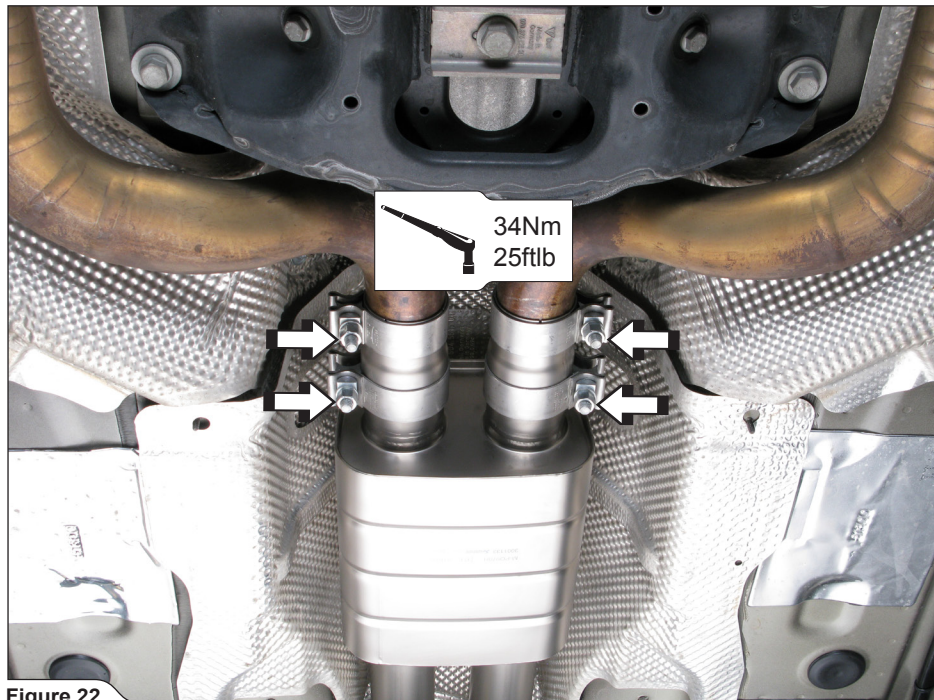

Figure 22

10. **For Turbo/Turbo S vehicle models only:** join the Akrapovič link pipes and original front pipes, using original double clamps. Tighten the clamps to a specified torque (**Figure 23**).

! **WARNING:** use anti-seize copper paste on clamp bolt and nut threads!

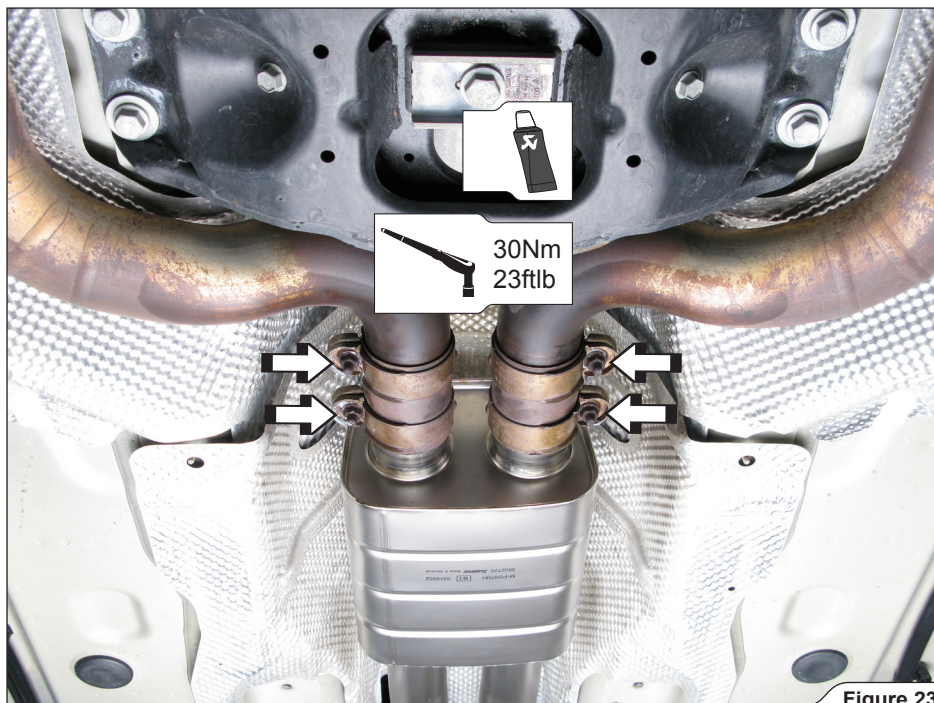

Figure 23

11. **For all vehicle models:** slide the Akrapovič double clamps onto the Akrapovič muffler pipes, as shown (Figure 24).

! **WARNING:** use anti-seize copper paste on clamp bolt and nut threads!



Figure 24

12. **For all vehicle models:** attach the mufflers onto the original rubber brackets, hand tighten the original muffler linkage and slide the Akrapović double clamps over the joints (**Figure 25**).

✂ INSTALLATION TIP: for easier mounting, lubricate the original rubber brackets.

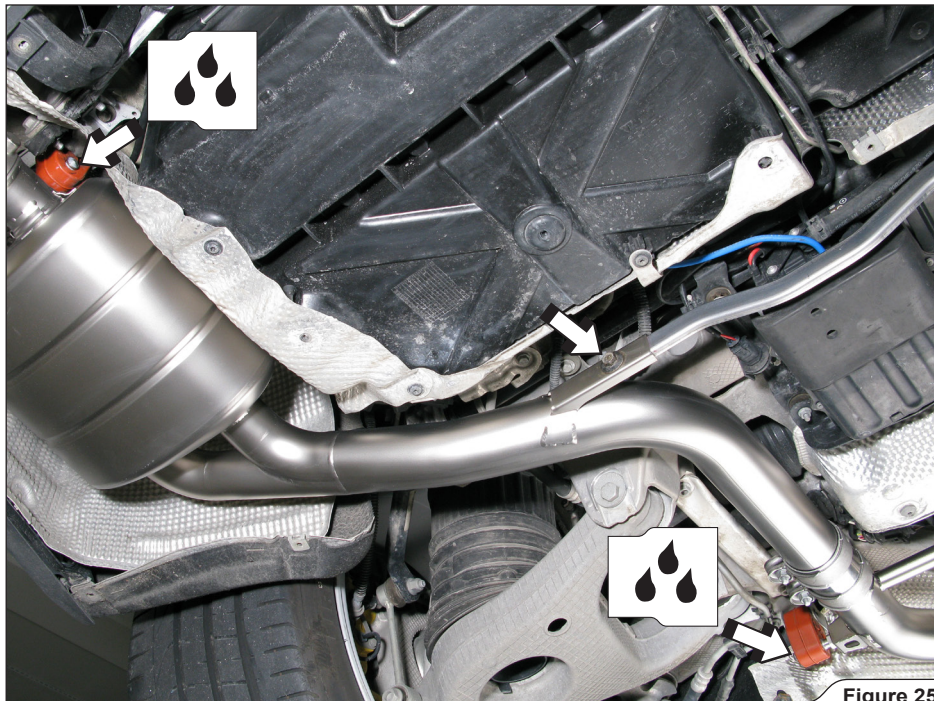

Figure 25

13. **For all vehicle models:** center the mufflers in respect to the rear bumper, tighten the double clamps and original muffler linkage (using original bolts and nuts) to a specified torques (**Figure 26**).

! **WARNING:** use anti-seize copper paste on linkage bolt threads!

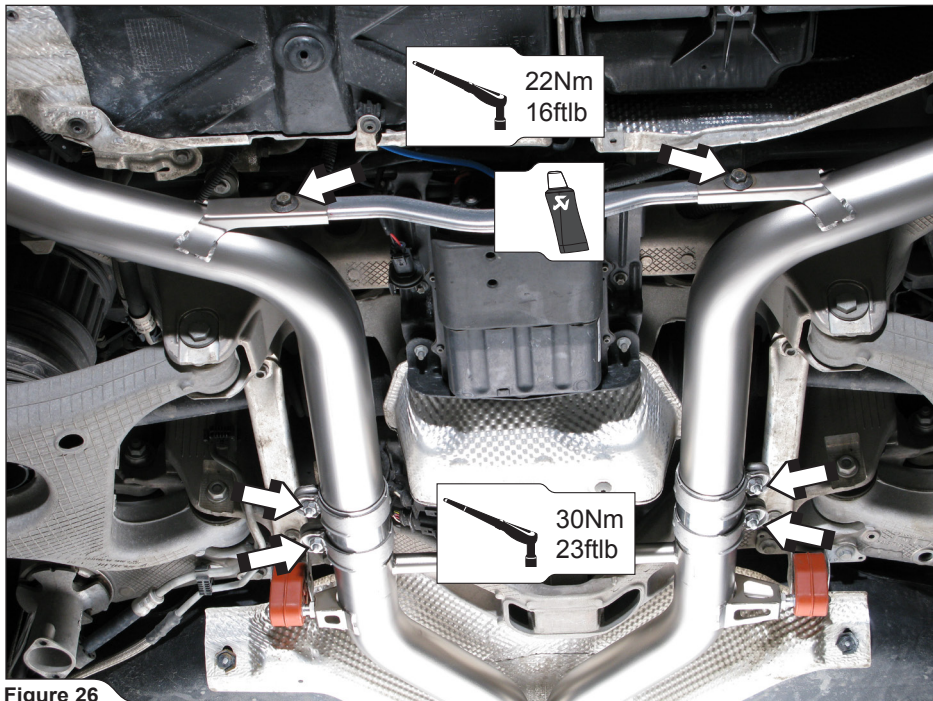

Figure 26

14. **For vacuum operated exhaust system valves only:** link the rubber vacuum hoses to the vacuum actuators on both mufflers (**Evolution EC type approved: Figure 27; Evolution: Figure 28**).



Figure 27

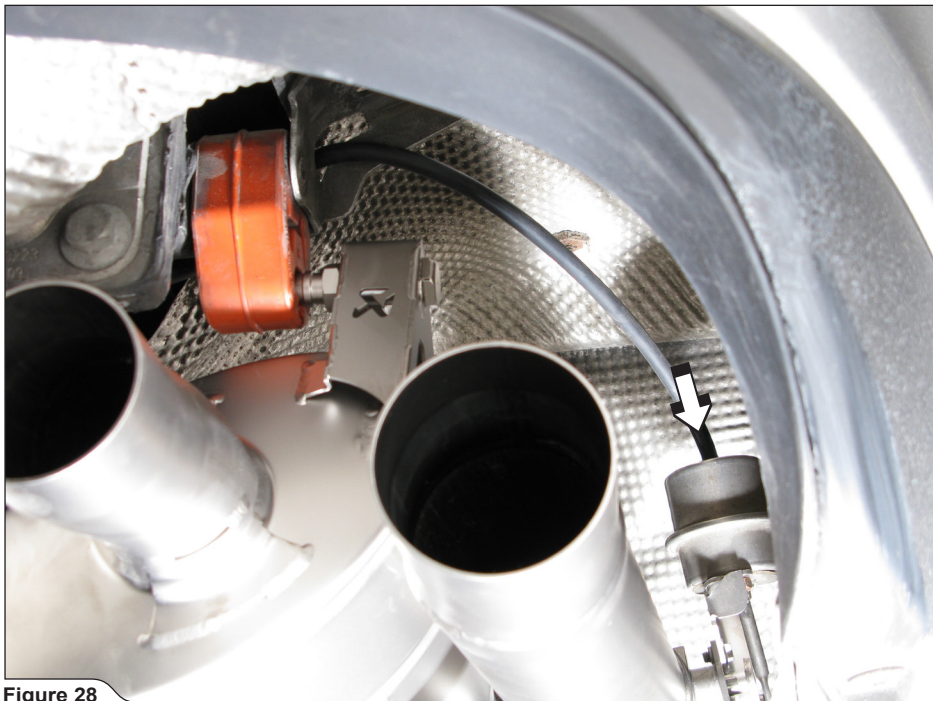

Figure 28

15. **For all vehicle models:** assemble both aluminium chassis reinforcements back onto the vehicle and tighten the bolts to a specified torques (**Figure 29**).

! **WARNING:** use anti-seize copper paste on all bolt threads!

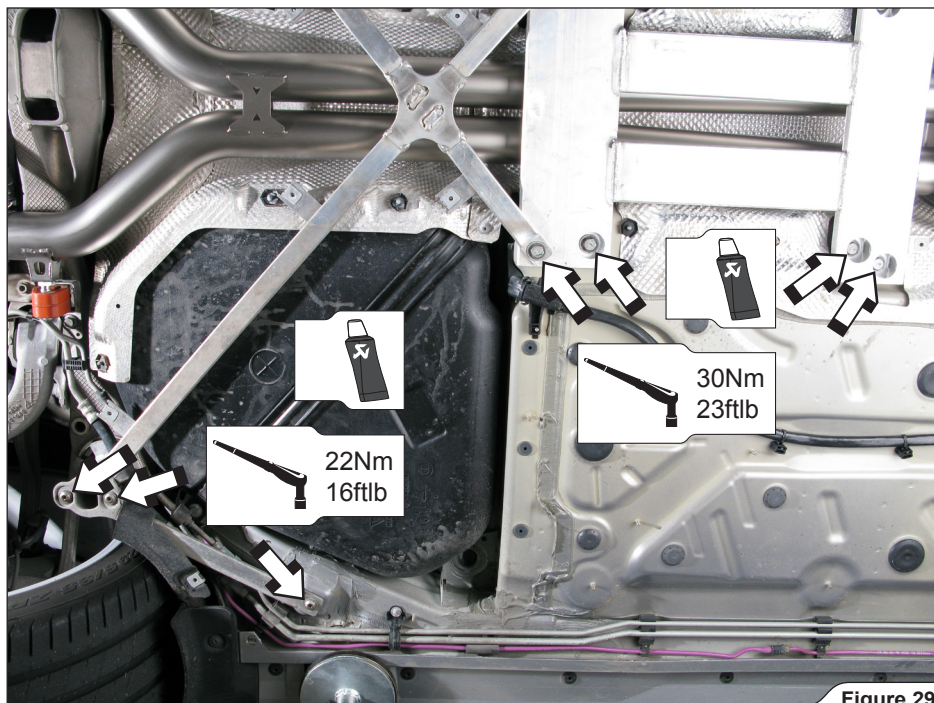

Figure 29

16. **For all vehicle models:** assemble the he chassis panels back onto the vehicle; tightening torque for all panel bolts and nuts: **2Nm/1.5ftlb** (Figure 30, 31).

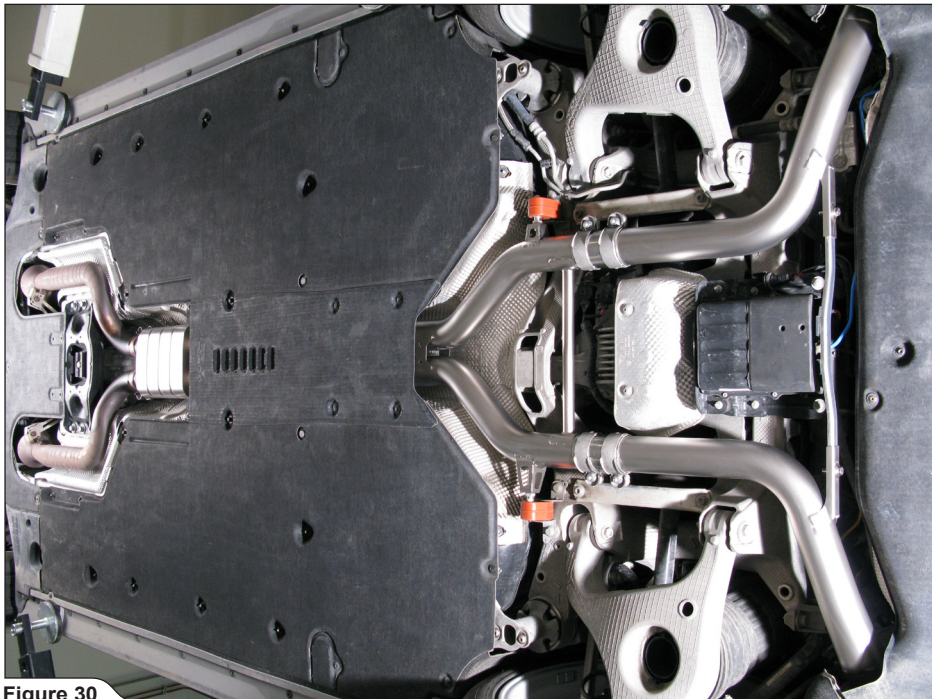

Figure 30



Figure 31

17. **For all vehicle models:** correctly assemble the clamps and spherical rings onto the Tail-Pipes, as shown (**Evolution EC type approved: Figure 32; Evolution: Figure 33**).

! **WARNING:** use anti-seize copper paste on clamp bolt threads!



Figure 32



Figure 33

18. **For all vehicle models:** slide the Akrapovič Tail-Pipes onto the muffler outlets. Center them in respect to rear bumper as shown (**Figure 34**).



Figure 34

19. **For all vehicle models:** tighten Tail Pipe clamps to a specified torque on both sides of the vehicle (**Evolution EC type approved: Figure 35; Evolution: Figure 36**).

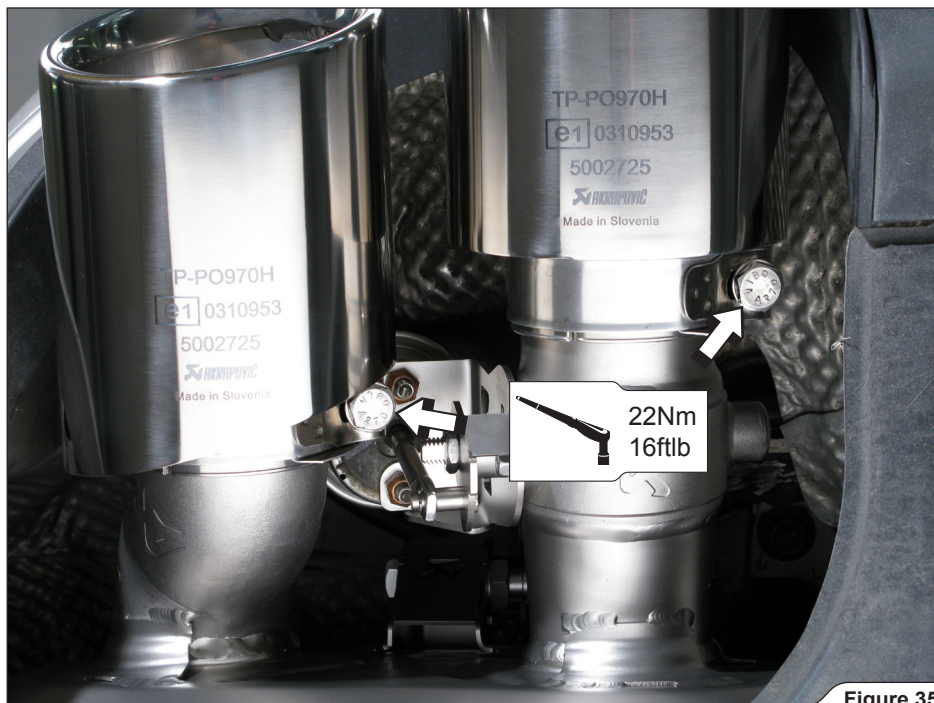

Figure 35

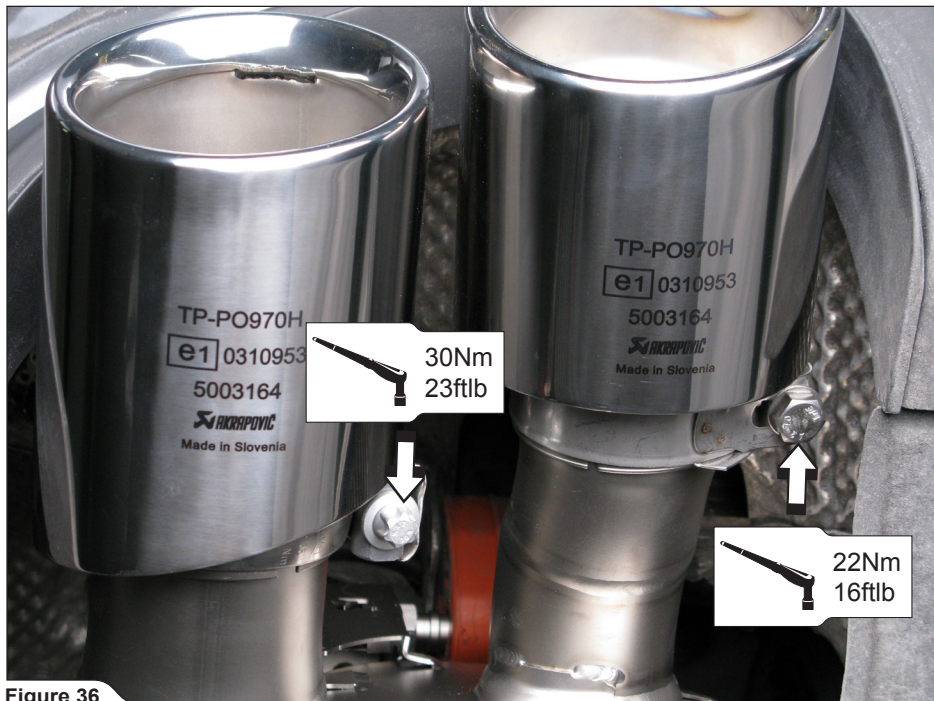

Figure 36

INSTALLATION OF THE OPTIONAL WIRELESS EXHAUST VALVE KIT FOR VEHICLE MODELS EQUIPPED WITH ORIGINAL EXHAUST SYSTEM VALVES:

1. Open the car boot, lift the boot panel and remove the tire reparation set (Figure 37).

! WARNING: we advise you to disconnect the car battery before exhaust valve kit installation!



Figure 37

2. Disconnect the three marked connectors and unscrew the two fuse box bolts (Figure 38).
! **WARNING:** make sure, that you don't damage any part of vehicle during this procedure!

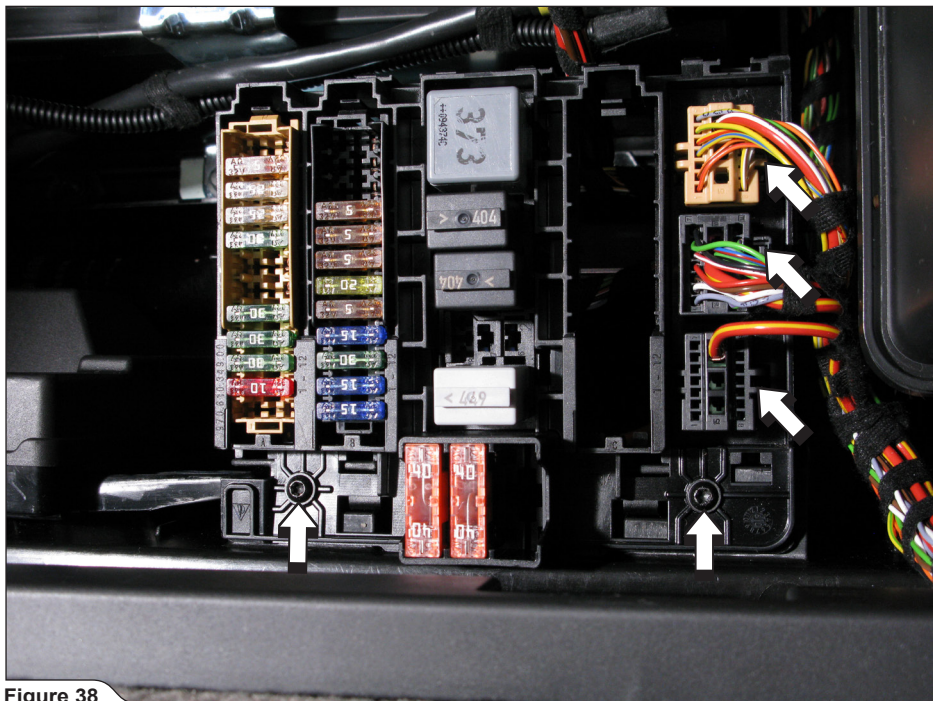

Figure 38

3. Move the fuse box out of the way, disconnect the marked connector and loosen the ECU bolt (Figure 39).

! **WARNING:** make sure, that you don't damage any part of vehicle during this procedure!

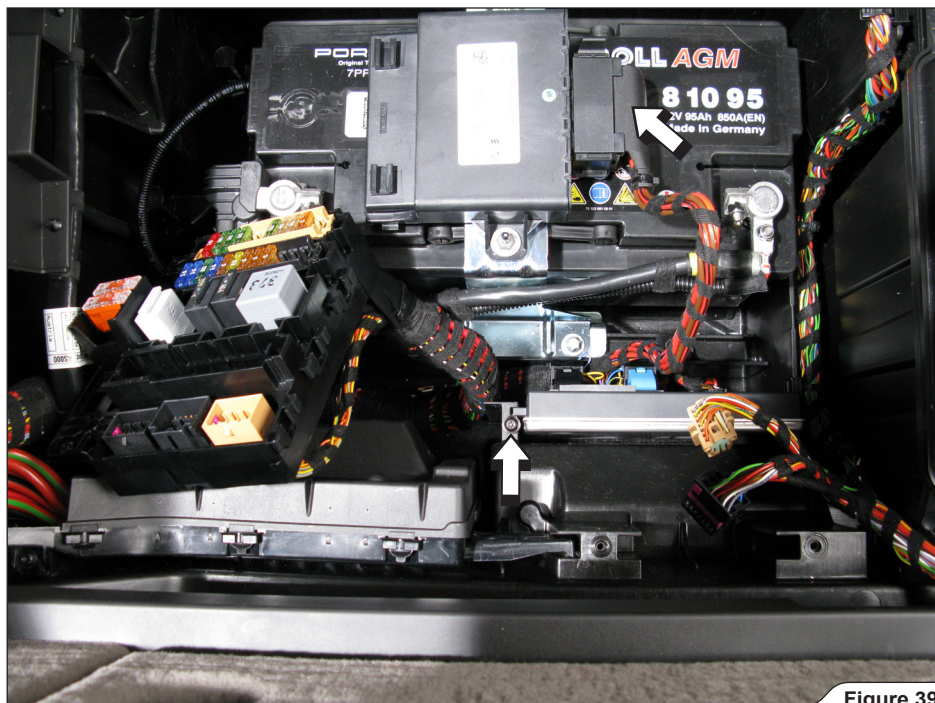

Figure 39

4. Pull the ECU unit out of the socket and disconnect the blue connector (Figure 40).
- !** **WARNING:** make sure, that you don't damage any part of vehicle during this procedure!

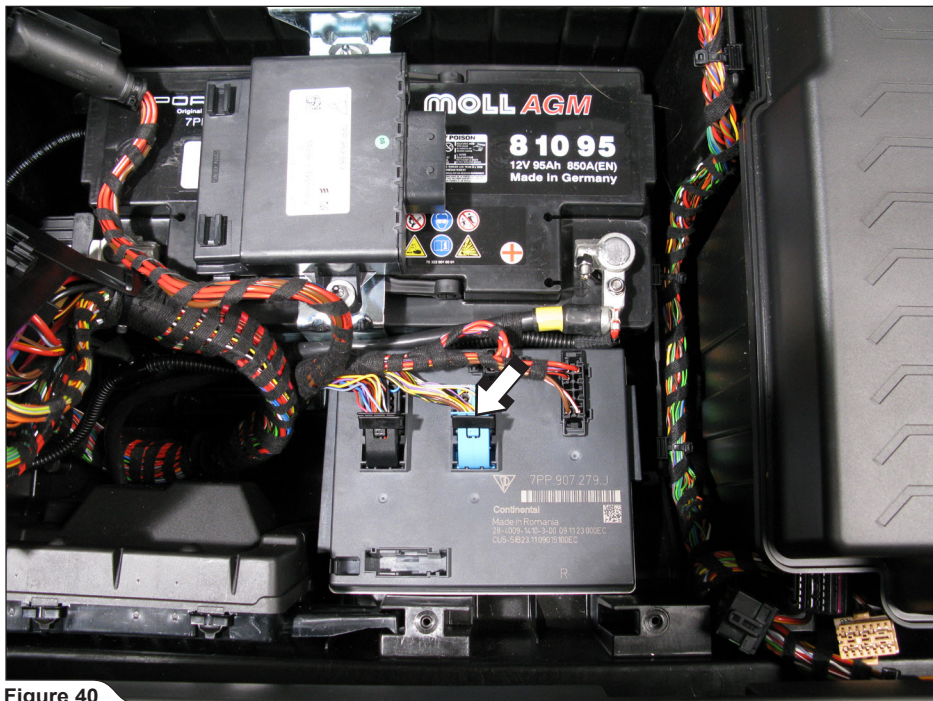

Figure 40

5. Dismantle the connector (Figure 41).

! **WARNING:** make sure, that you don't damage any part of vehicle during this procedure!

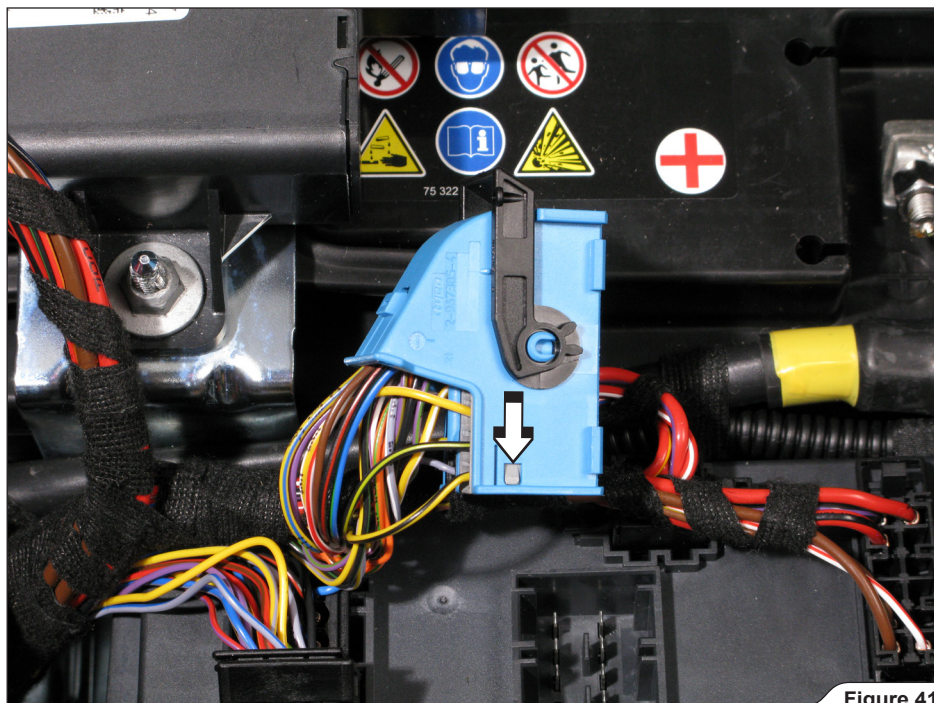

Figure 41

6. Remove the marked connector pin (black wire with yellow stripe) (Figure 42).

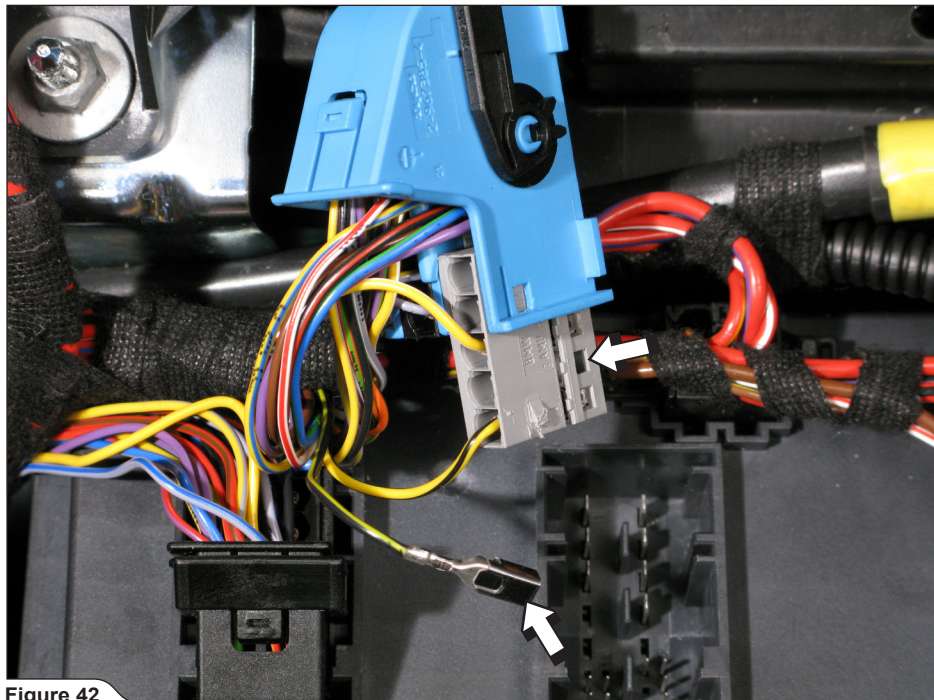

Figure 42

7. Transmitter with installation fittings: **red wire**-fuse box pin (power supply), **black wire**-ground terminal, **blue wire**-pin to original blue connector, **grey wire**-pin to original yellow wire with black stripe (Figure 43).

! **CAUTION:** the black electromagnetic valve connector is not used in this case; secure it to the harness, using tie wrap!

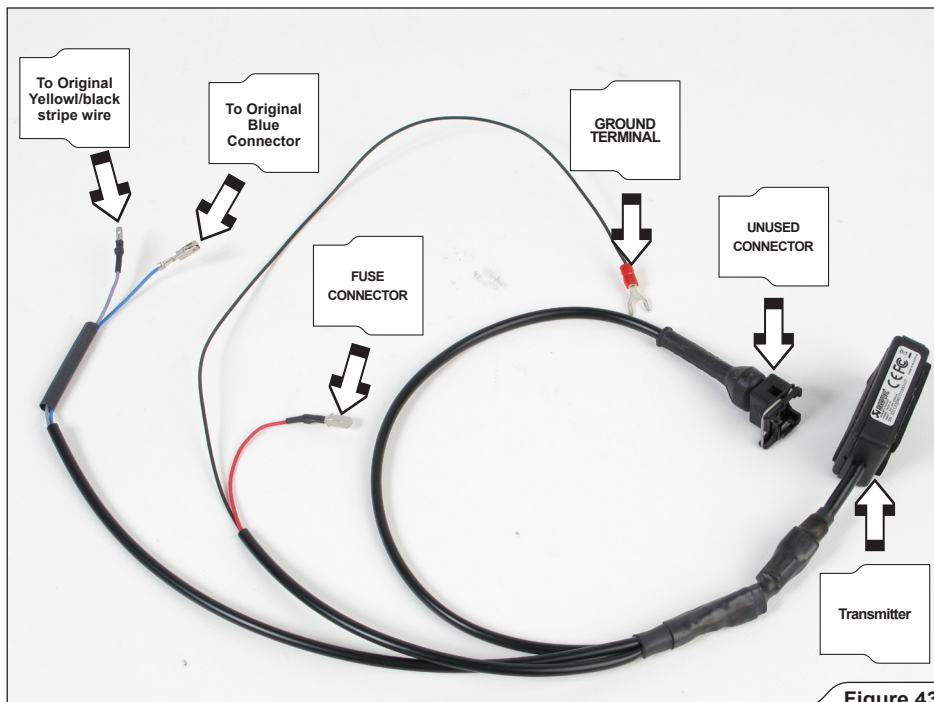

Figure 43

8. Link the transmitters grey wire to original black wire with yellow stripe, correctly insert the transmitters blue wire pin into the original connector (replaces the original black wire with yellow stripe) and assemble the original connector (**Figure 44**).

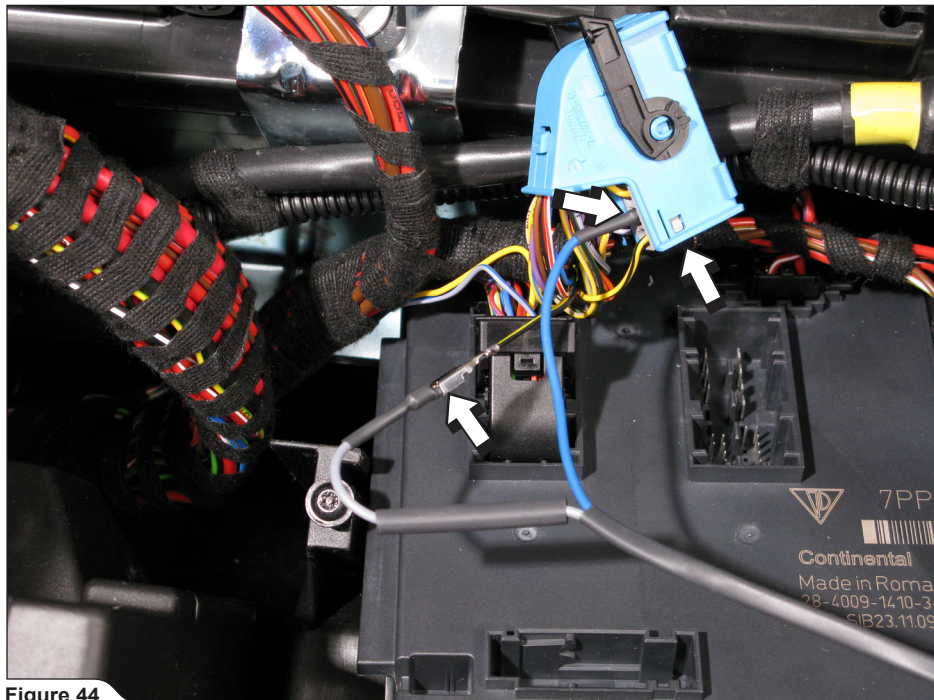

Figure 44

9. Connect the original blue connector back into the ECU and insulate the wire connection (grey wire - black with yellow stripe wire), using heat shrinkable insulation (included in Akrapovič kit) (**Figure 45**).

! **WARNING:** make sure, that you don't damage any part of vehicle during this procedure!

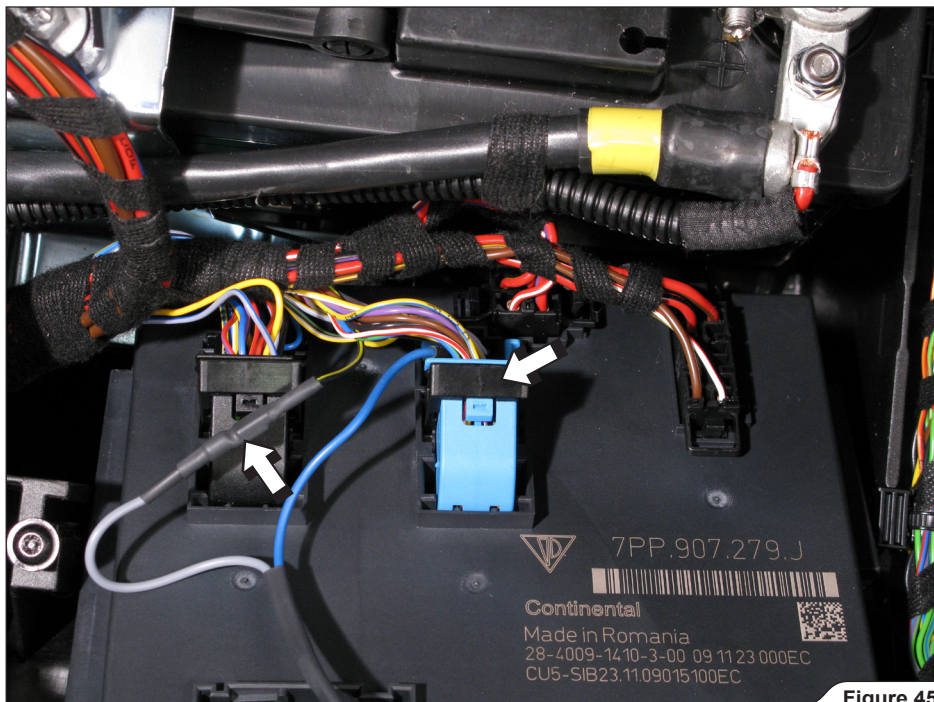

Figure 45

10. Reinstall the ECU, fuse box and all connectors in the reverse order from the order in which they were removed.

Link the transmitters red wire pin to the **right** side of the free fuse spot, screw the black ground wire to the battery **negative** terminal and tuck the transmitter, as shown (**Figure 46, 47, 48**).

! **WARNING: direct and secure (use additional plastic tie wraps) all transmitter wires!**

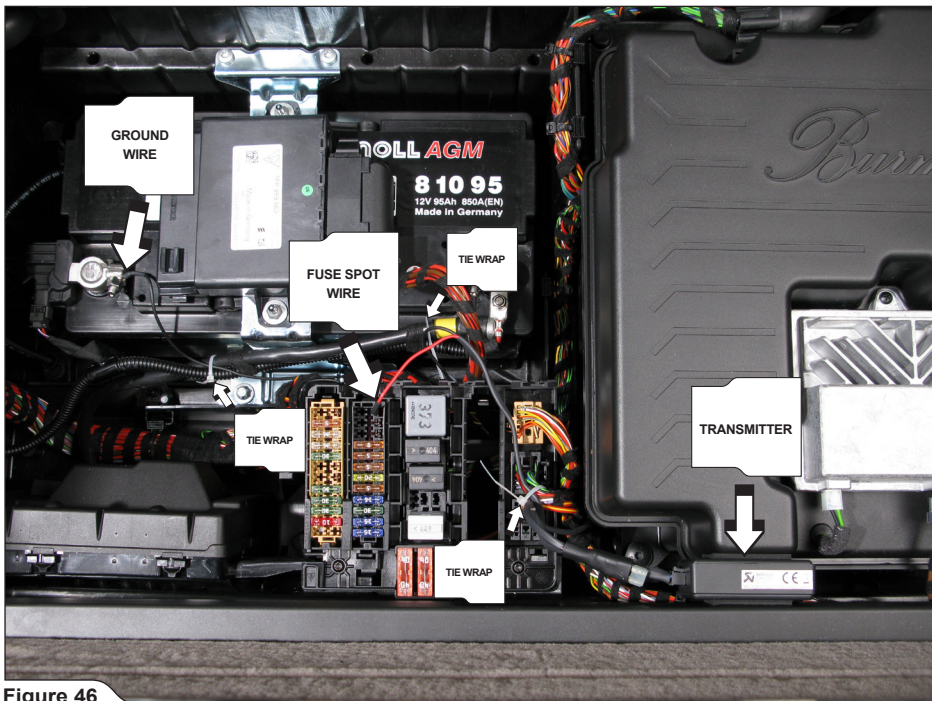

Figure 46

! **WARNING:** make sure, that you install the red wire terminal to the **RIGHT SIDE** of the fuse spot (Figure 47)!

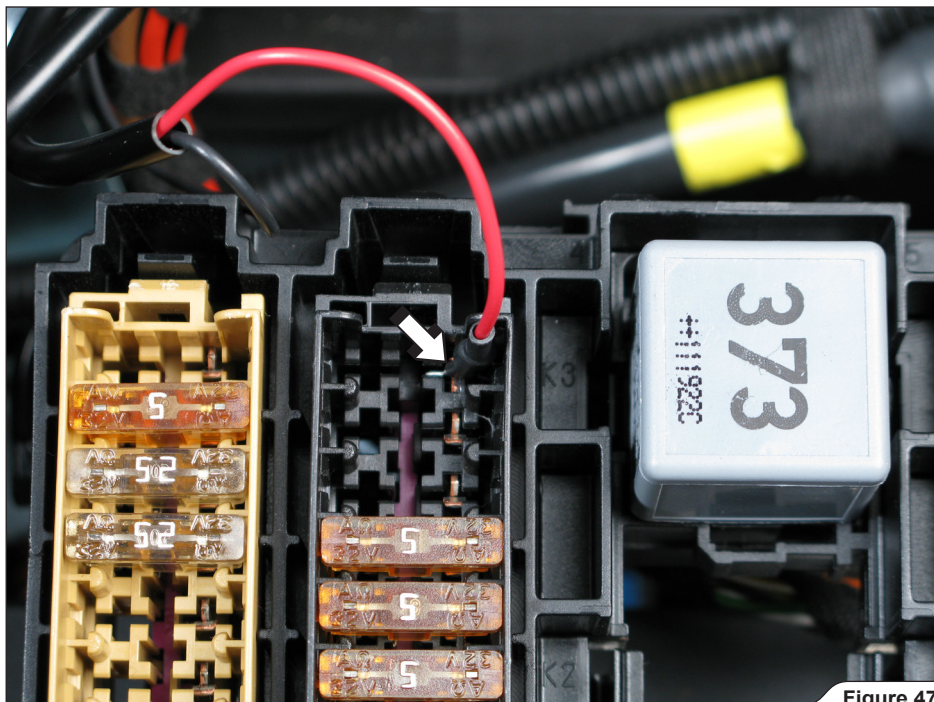

Figure 47

! **WARNING:** tighten the ground wire to the **NEGATIVE** terminal, as shown (Figure 48)!



Figure 48

11. Replace all dismantled original parts in the reverse order from the order in which they were removed. Check vehicle manufacturer manual for tightening torques.

! **WARNING: make sure not to injure yourself or damage any part of the vehicle during this procedure!**

INSTALLATION OF THE OPTIONAL WIRELESS EXHAUST VALVE KIT FOR VEHICLE MODELS WITHOUT ORIGINAL EXHAUST SYSTEM VALVES:

1. Remove the front right wheel. Unscrew the marked nuts and bolts and remove the wheel arch panel off the vehicle (**Figure 49**).

! **WARNING:** make sure not to injure yourself, or damage any part of the vehicle during this procedure!

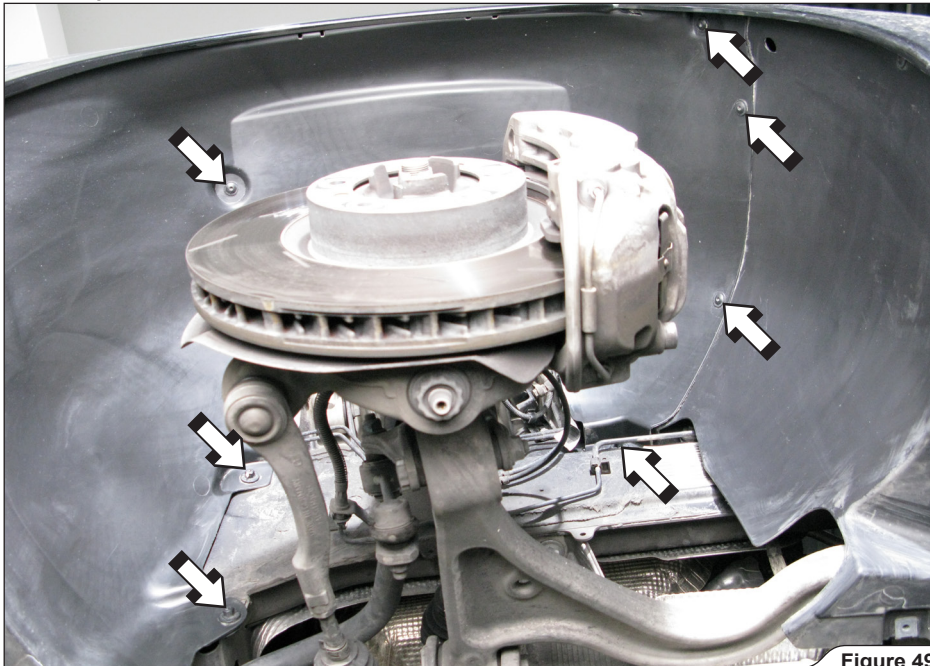

Figure 49

2. Unscrew the marked bolts and remove the PVC cover from the right side of the engine compartment (Figure 50).

! **WARNING:** make sure, that you don't damage any part of vehicle during this procedure!

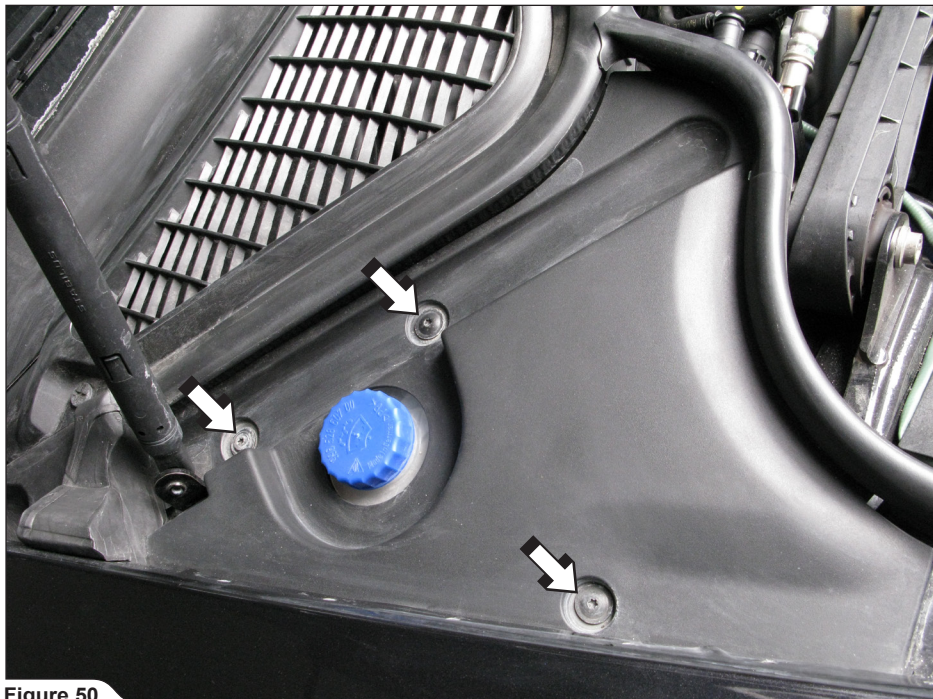

Figure 50

3. Connect the Akrapovič 460cm vacuum hose to the free outlet of the original vacuum distributor, located at the back/right side of the engine compartment (**Figure 51**).

! **WARNING:** make sure not to injure yourself, or damage any part of the vehicle during this procedure!



Figure 51

4. Direct and secure the Akrapovič 460cm vacuum hose from vacuum source to the luggage compartment, as shown (Figure 52, 53, 54, 55, 56).

! **WARNING:** direct and secure (use additional plastic tie wraps) the rubber vacuum hose in such a way, that it doesn't touch any hot or moving parts of the vehicle!



Figure 52

- ! **WARNING:** direct and secure (use additional plastic tie wraps) the rubber vacuum hose in such a way, that it doesn't touch any hot or moving parts of the vehicle!

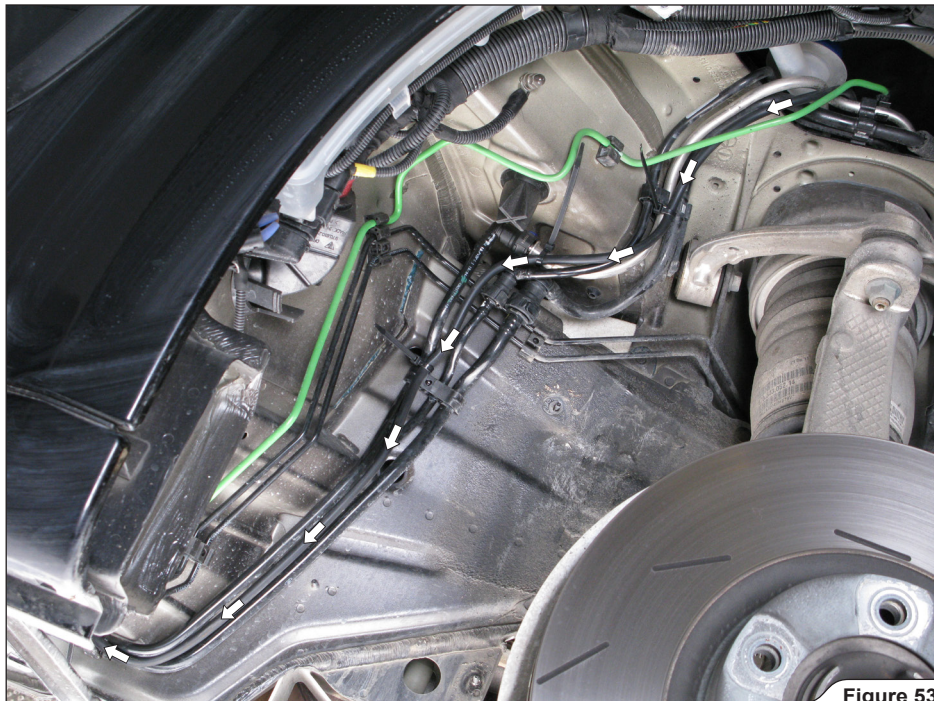

Figure 53

! **WARNING:** direct and secure (use additional plastic tie wraps) the rubber vacuum hose in such a way, that it doesn't touch any hot or moving parts of the vehicle!

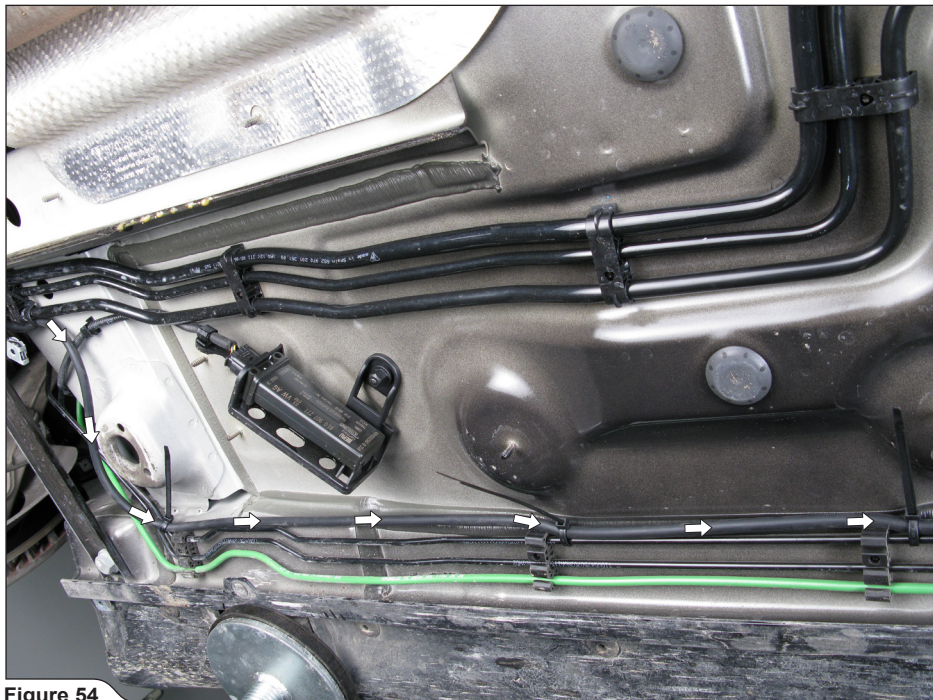

Figure 54

- ! **WARNING:** direct and secure (use additional plastic tie wraps) the rubber vacuum hose in such a way, that it doesn't touch any hot or moving parts of the vehicle!

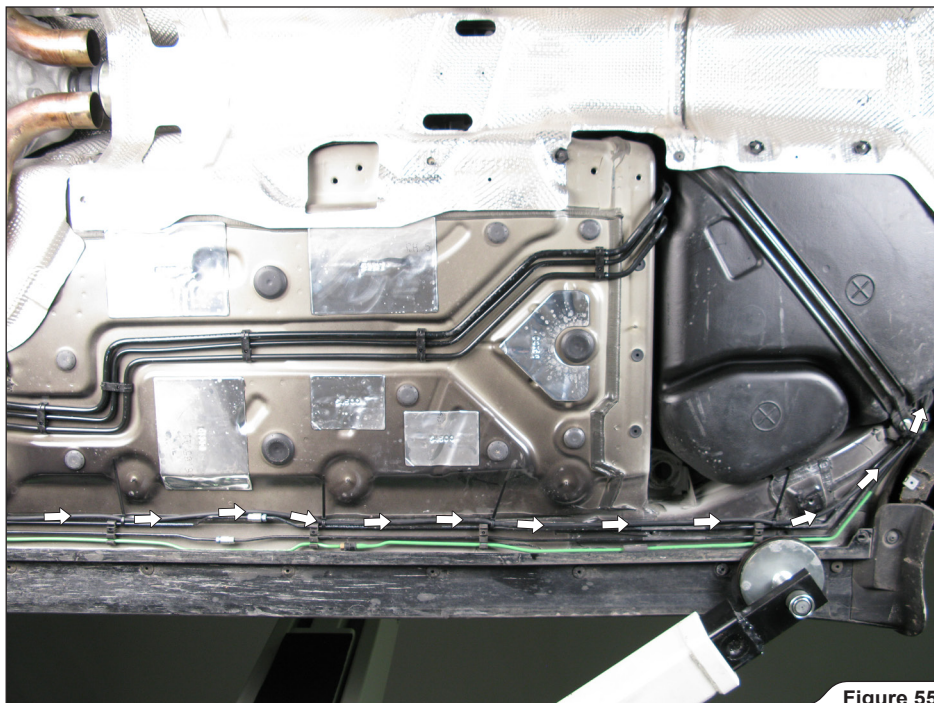

Figure 55

! **WARNING:** direct and secure (use additional plastic tie wraps) the rubber vacuum hose in such a way, that it doesn't touch any hot or moving parts of the vehicle!

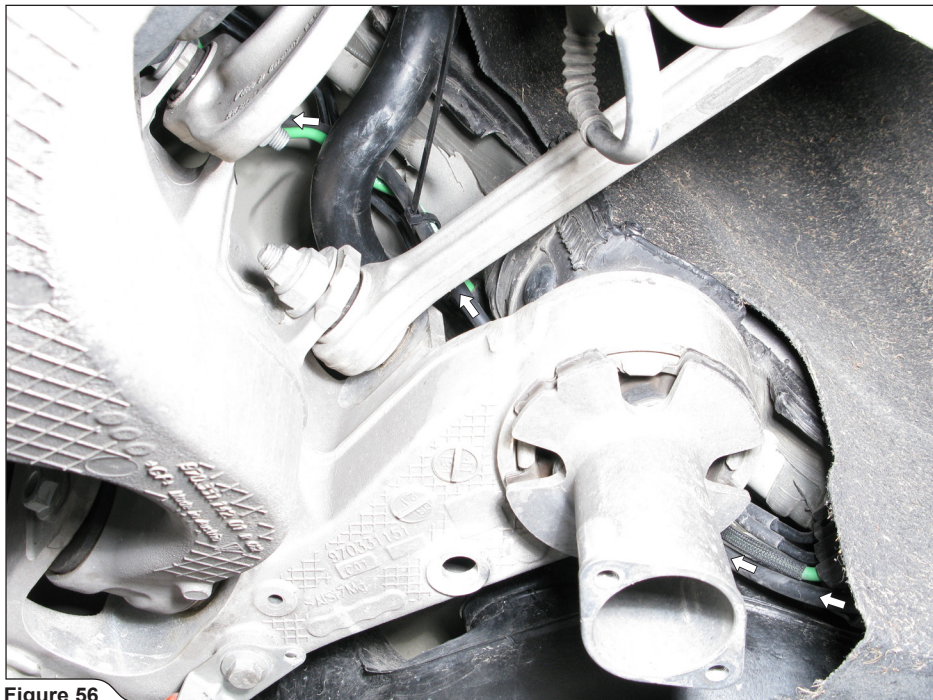

Figure 56

5. Open the car boot, lift the boot panel and remove the tire reparation set (**Figure 57**).

! **WARNING:** we advise you to disconnect the car battery before exhaust valve kit installation!



Figure 57

6. Insert the two PVC vacuum tubes from Akrapovič installation kit, through marked harness rubber grommet (**Figure 58**).

! **WARNING:** make sure, that you don't damage any part of vehicle during this procedure!

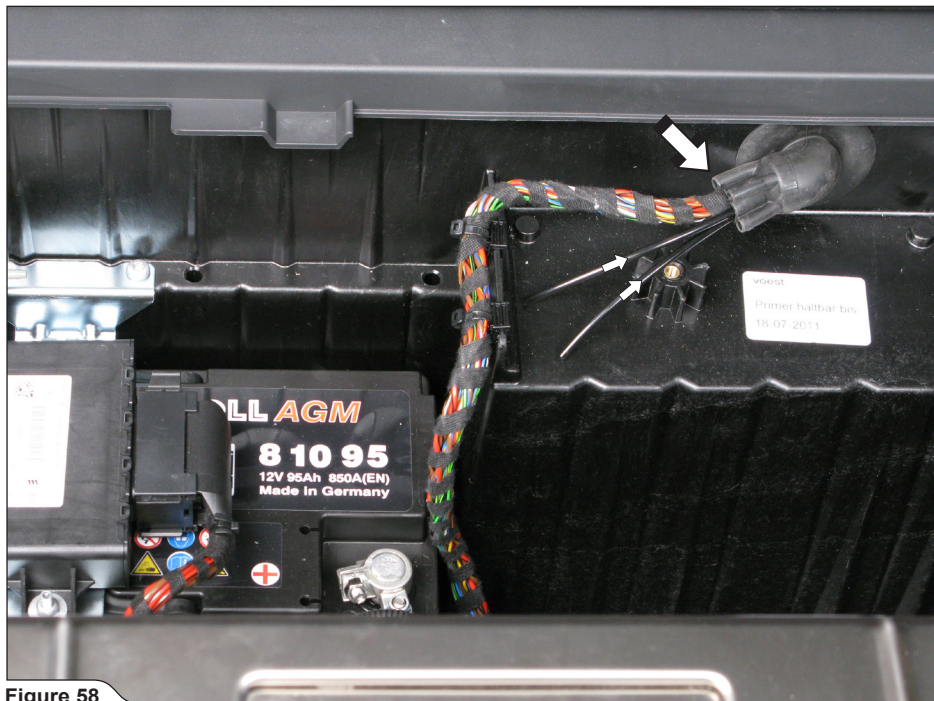

Figure 58

7. Link the Akrapovič vacuum hose (460cm) from vacuum source to the PVC vacuum tube leading into the luggage compartment and connect the plastic Y piece distributor to the PVC vacuum tube leading out of the luggage compartment, using Akrapovič 5cm vacuum hose (**Figure 59**). v

! **WARNING:** direct and secure (use additional plastic tie wraps) the rubber vacuum hoses in such a way, that they don't touch any hot or moving parts of the vehicle!

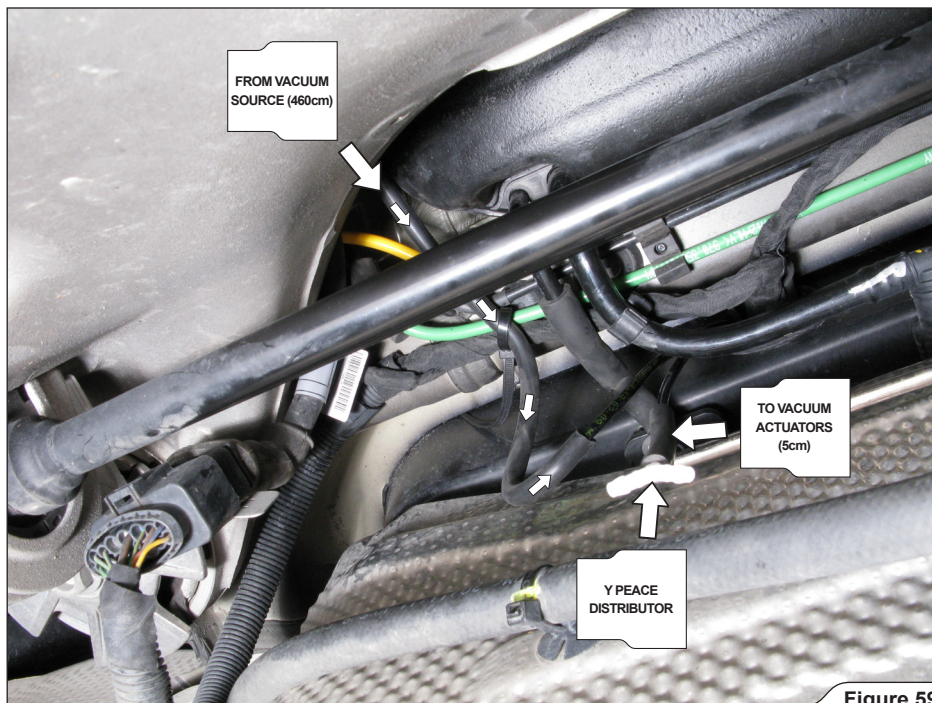

Figure 59

8. Link the Akrapovič vacuum hoses from plastic Y piece distributor to the vacuum actuators; LEFT: 160cm vacuum hose, RIGHT: 100cm vacuum hose (Figure 60, 61, 62).

! **WARNING:** direct and secure (use additional plastic tie wraps) the rubber vacuum hoses in such a way, that they don't touch any hot or moving parts of the vehicle!

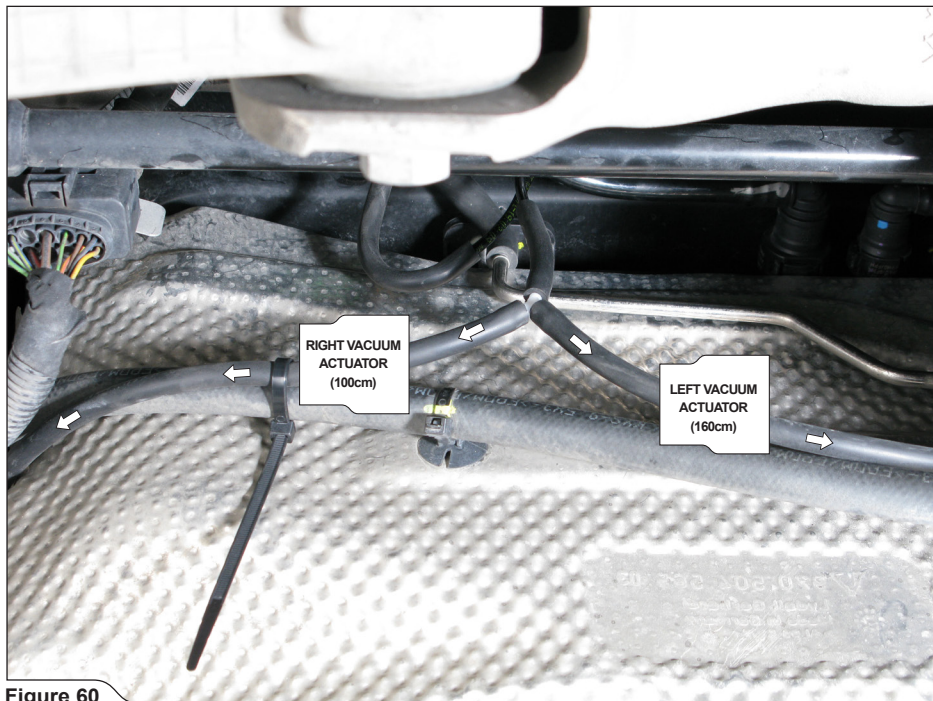

Figure 60

- ! **WARNING:** direct and secure (use additional plastic tie wraps) the rubber vacuum hose in such a way, that it doesn't touch any hot or moving parts of the vehicle!



Figure 61

! **WARNING:** direct and secure (use additional plastic tie wraps) the rubber vacuum hose in such a way, that it doesn't touch any hot or moving parts of the vehicle!

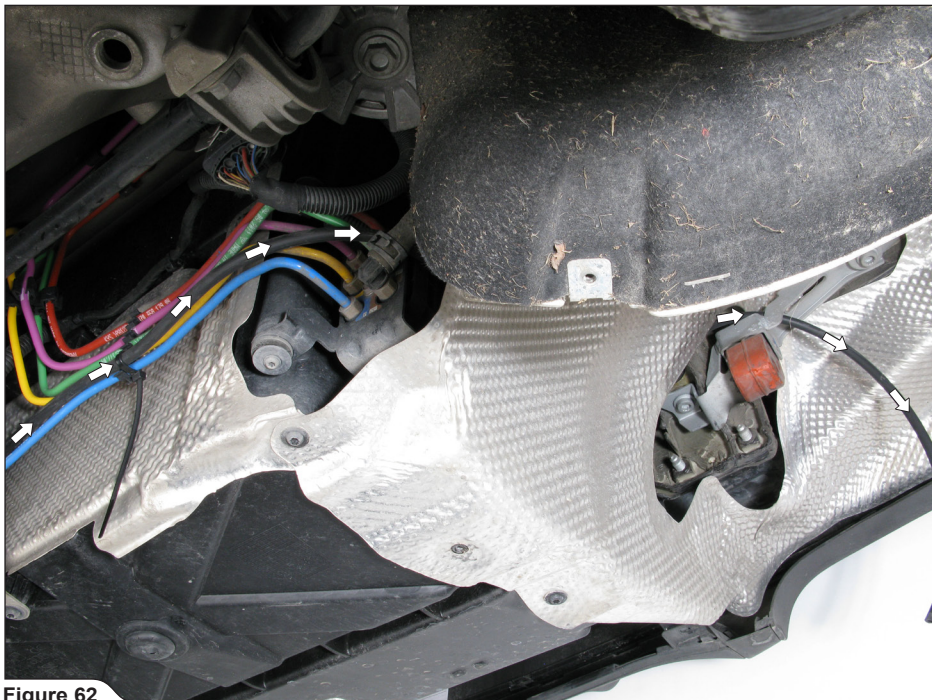

Figure 62

- Assemble the electromagnetic valve with bracket (both from Akrapovic installation kit) and bolt the bracket onto the chassis, using original bolt, as shown (**Figure 63**).

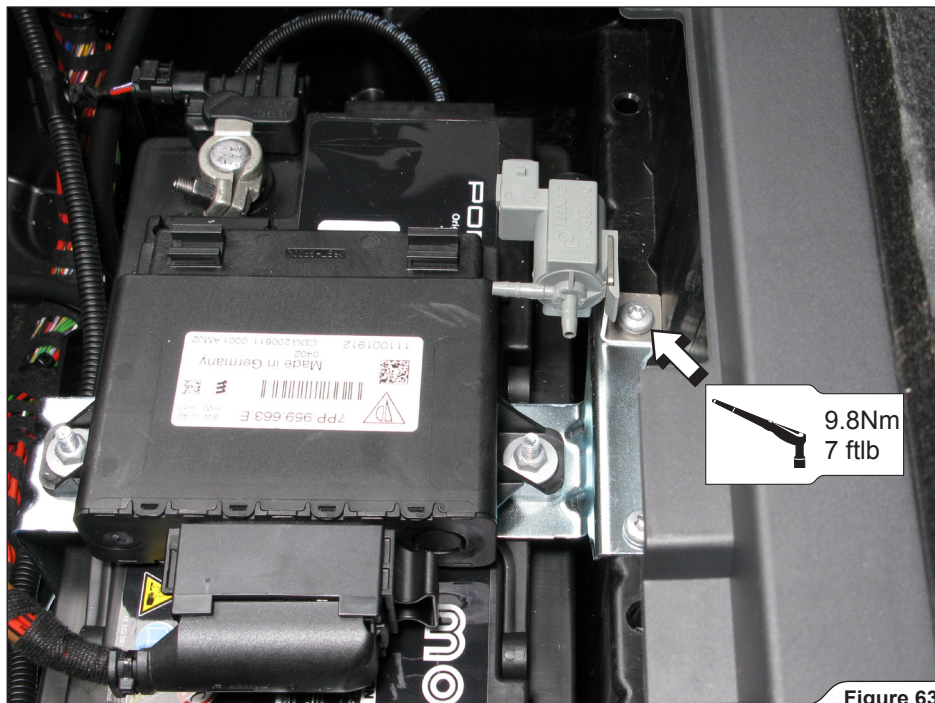

Figure 63

10. Connect the two 35cm rubber vacuum hoses from Akrapovič installation kit, to the PVC vacuum tubes, as shown (Figure 64).

! **WARNING:** direct the rubber vacuum hose in such a way, that it doesn't touch any hot or moving parts of the vehicle!

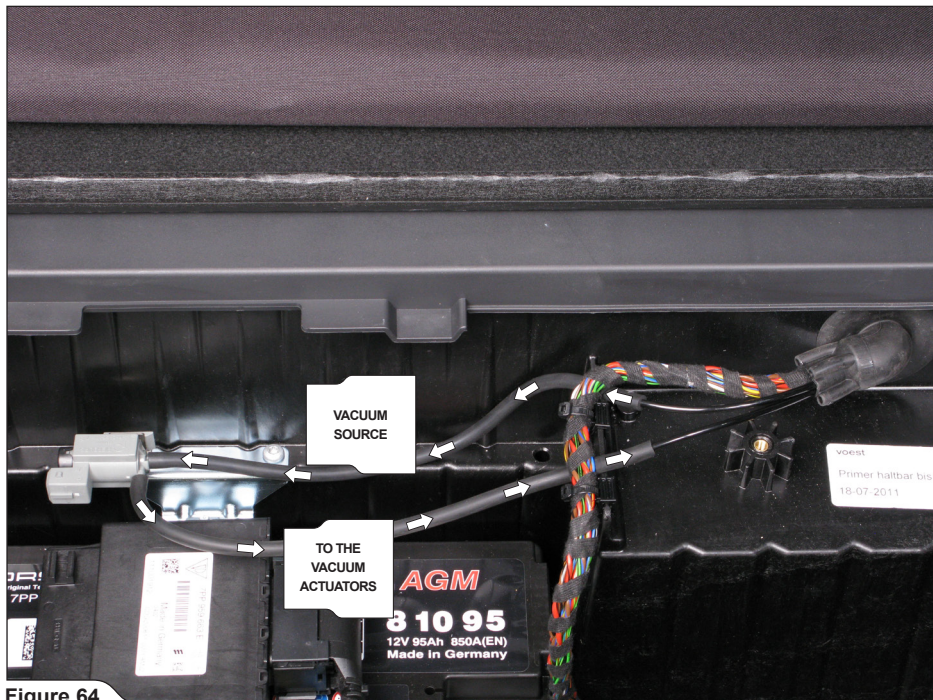

Figure 64

11. Transmitter with installation fittings: **red wire**-fuse box pin (power supply), **black wire**-ground terminal, **black connector**-to electromagnetic valve (**Figure 65**).

! **CAUTION:** the gray and blue wires are not used in this case!

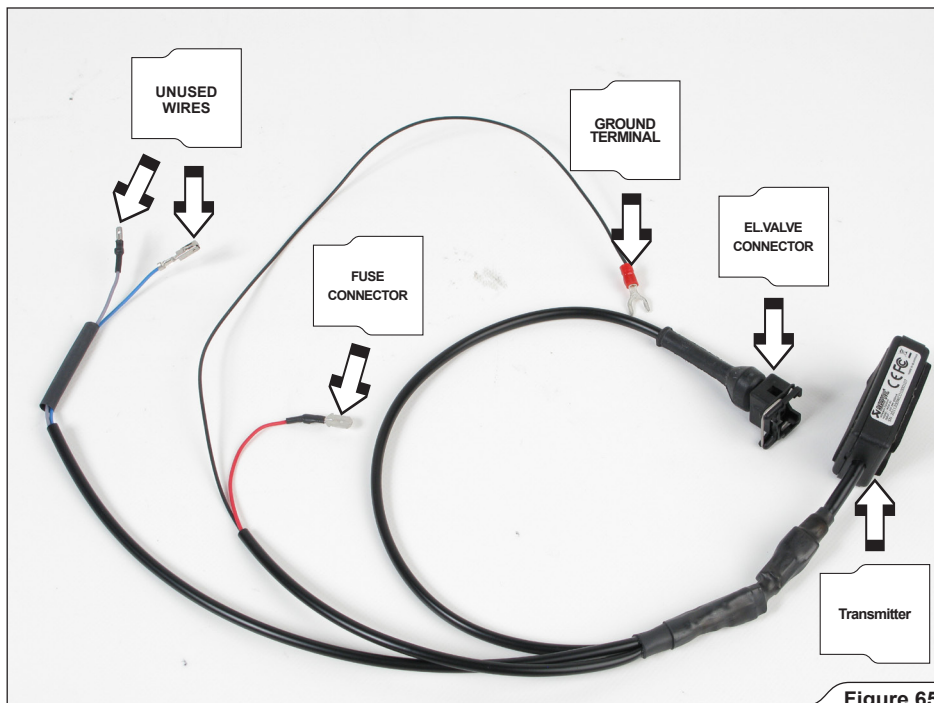

Figure 65

12. Cut off the unused gray and blue wire terminals/connectors and insulate the wires, using heat shrinkable insulation (included in Akrapovič kit) (**Figure 66**).

! **WARNING:** insulate the unused wires in such a way, they can't get in contact!

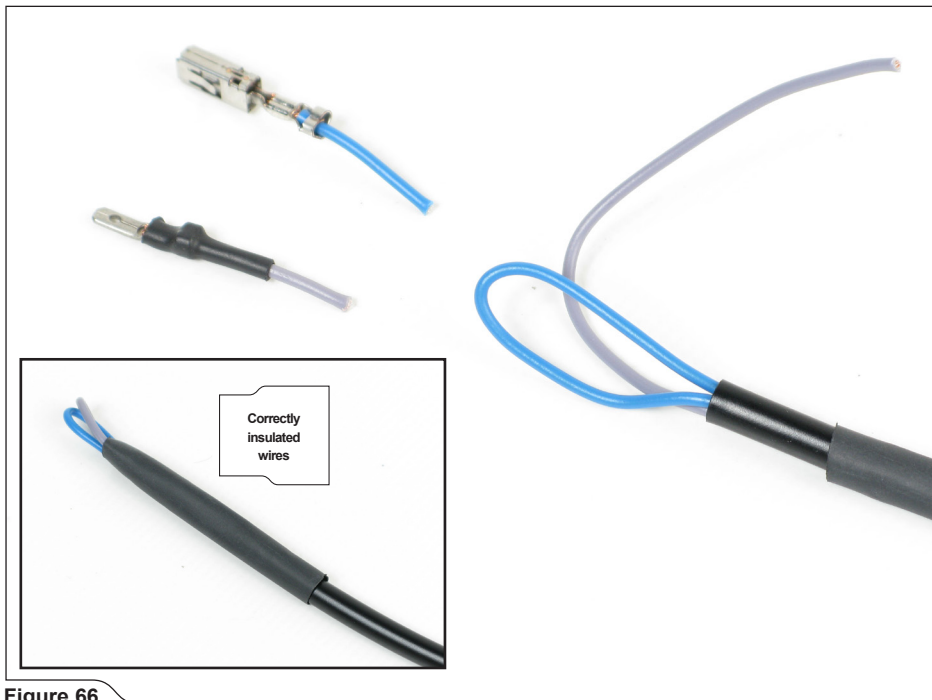

Figure 66

- Link the transmitters red wire pin (power supply) to the **right** side of the free fuse spot, screw the black ground wire to the battery **negative** terminal, connect the connector to the electromagnetic valve and secure the transmitter, as shown (**Figure 67**).

! **WARNING: direct and secure (use additional plastic tie wraps) all transmitter wires!**

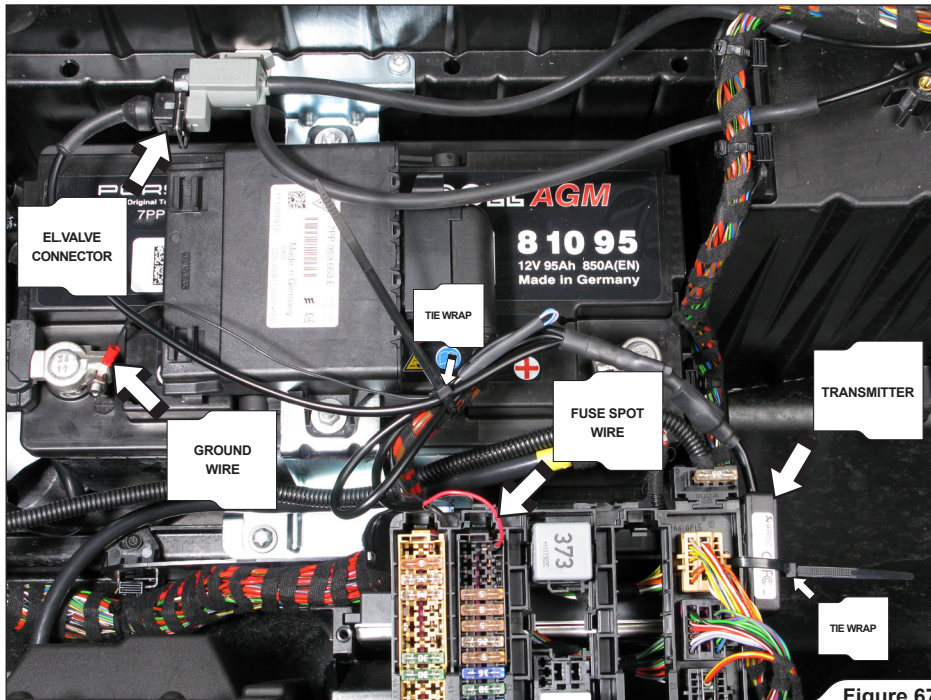

Figure 67

! **WARNING:** make sure, that you install the red wire terminal to the **RIGHT SIDE** of the fuse spot (Figure 68)!

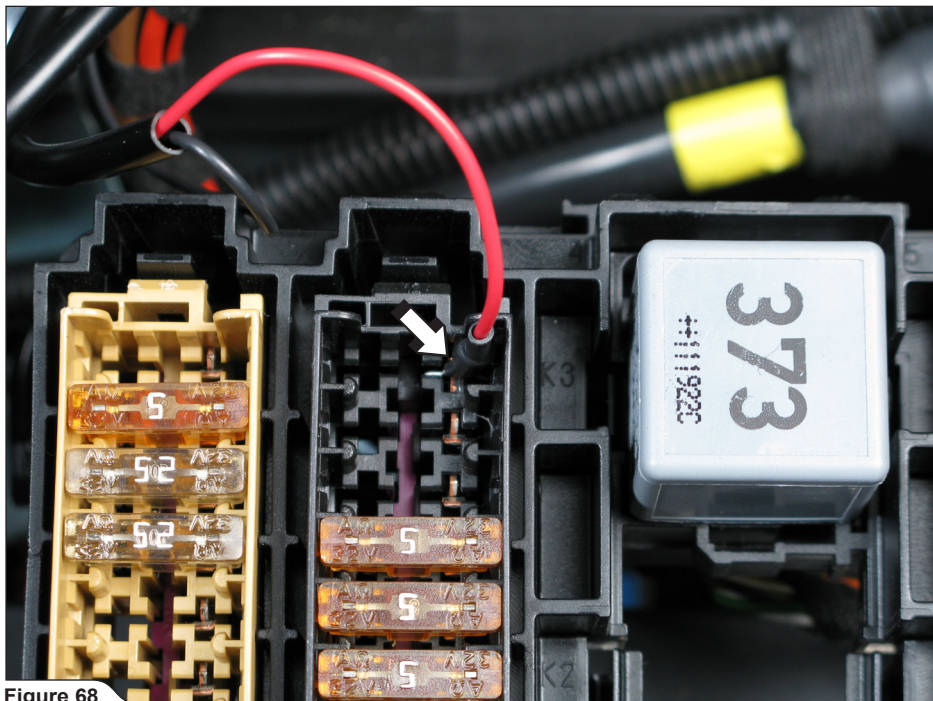

Figure 68

14. Replace all dismantled original parts in the reverse order from the order in which they were removed. Check vehicle manufacturer manual for tightening torques.

! **WARNING: make sure not to injure yourself or damage any part of the vehicle during this procedure!**

! CAUTION: secure all vacuum tubing connections, using clamps from Akrapovič installation kit! Install the clamps with corresponding tube clamp pliers (Figure 69).



Figure 69

Final installation:

- ! **WARNING: check vehicle manufacturer manual for tightening torques (for dismantled stock parts)!**
- ! **WARNING: make sure all the nuts and bolts are sufficiently tightened. In case the exhaust system touches the cowling or other parts, repeat the adjustment of the exhaust system or contact your authorized dealer.**

MAINTENANCE OF THE AKRAPOVIČ EXHAUST SYSTEM:

1. Clean the titanium exhaust components with a multi-purpose spray lubricant (WD-40 or equivalent), carbon fiber exhaust components with soft and dry cloth and stainless steel components with soft cloth sprayed with contact cleaner, then wipe with soft and dry cloth. A change in the color of the exhaust system is normal due to high temperatures.
2. Periodically make sure all the bolts and springs are sufficiently tight.

- ! **WARNING: clean all exhaust components before the first start of the engine or the stains will burn onto the surfaces!**
- ! **IT IS NORMAL FOR WHITE SMOKE TO COME OUT OF THE MUFFLER AT FIRST OPERATION.**
- ! **DO NOT STAND BEHIND THE MUFFLER AT FIRST OPERATION.**
- ! **DO NOT USE AUTOMOTIVE WHEEL CLEANERS OR ANY CLEANING PRODUCTS WHICH CONTAIN ACIDIC ADDITIVES TO CLEAN THE AKRAPOVIČ EXHAUST SYSTEMS.**

WARNING

Please note that certain aftermarket exhaust systems may not comply with applicable California laws and regulations, and may therefore be prohibited for use on California highways or roads, or on roads or vehicles otherwise subject to emissions control requirements.

Akrapovič exhaust systems for automobiles and motorcycles mounted downstream of the catalytic converter (also known as “cat-back systems”) are considered “replacement parts” in California by the California Air Resources Board (CARB), and do not require an exemption or executive order from CARB to be sold in California. However, California prohibits the use of any aftermarket exhaust system that modifies, removes or replaces original equipment catalysts, unless CARB has issued an Executive Order as to such part or system.

Further, Akrapovič parts or exhaust systems used or intended for use on “racing vehicles” (i.e. a competition vehicle used exclusively for competition on closed-course circuits) do not require an exemption or Executive Order from CARB to be sold in California. However, such parts are prohibited from use on California public highways or roads, even if occasionally used “off-road.”

www.akrapovic.com

