



2014+ MAZDA3 MUD FLAP INSTALLATION INSTRUCTIONS

For high resolution color images of these instructions, please visit <http://www.rallyarmor.com>

Check wheel clearance after installation, especially vehicles outfitted with non-OEM wheels and suspensions.

To protect your Rally Armor mud flap set, care must be taken during parking and reversing.

Rally Armor is not responsible for damage or loss of installed flaps.



YOUR MOUNTING HARDWARE CONSISTS OF:

Quantity	Hardware Item	Item ID
10	Flat U Clips	Uclip
12	Small Washers	SmWash
2	Lock Nuts	SSLnut
2	Short Screws	.75SS
8	Standard Screws	1SS
2	Inserts	Ins3
2	Front Mounting Brackets	HMF31-FR-BR
2	Rear Mounting Brackets	HMF14/16-R-BR

GUIDE TO SCREWS PROVIDED:

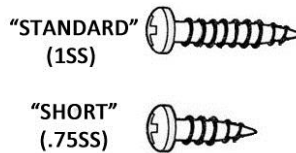

HOW TO REMOVE STOCK FASTENERS:

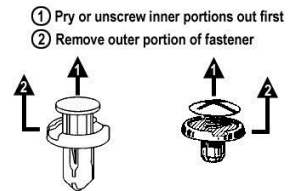

Important Notes

Recommended tools: Offset, ratcheting or stubby Phillips screwdriver, small flat head screwdriver, drill and bit assortment, 7/16" wrench, marker.

Cautionary Tip: The hardware is strong and self-threading but over-tightening the clips is not advised.

Installation Tip: To ease installation and avoid damage to existing OEM clips during removal, a well-lit, climate controlled installation environment is recommended.

Parking and Reversing: Any extended mud flap application can be damaged or dislodged should they get caught in between a tire and a curb or object. To protect your Rally Armor mud flap set, care must be taken during parking and reversing.

To the customer: Retain these instructions after installation. They may be necessary for installing other optional parts or removal of this accessory.

To the installer: Please return these instructions to the customer after installation. Always test and check wheel clearance before returning vehicle

CAREFULLY HAND THREAD LOCK NUTS TO BOLT FIRST TO AVOID CROSSTHREADING



A MISALIGNED NUT WILL DAMAGE OR SHEAR A BOLT TIGHTEN AFTERWARDS ONLY UNTIL SNUG

REPLACEMENTS FOR MIS-INSTALLED, DAMAGED OR LOST HARDWARE DURING INSTALLATION ARE THE SOLE RESPONSIBILITY OF THE INSTALLER

Front Mud Flap Installation

- **(Figure A)** Park vehicle on an even surface. Turn the steering wheel towards the side you are working on. Remove 3 outer fender liner fasteners.
- **(Figure B)** Pull liner away to gain access to inner fender. Place a Flat U clip (UClip) over each of the 2 lower mounting points as shown.
- **(Figure C)** Replace liner as before, and re-install upper mounting fastener.

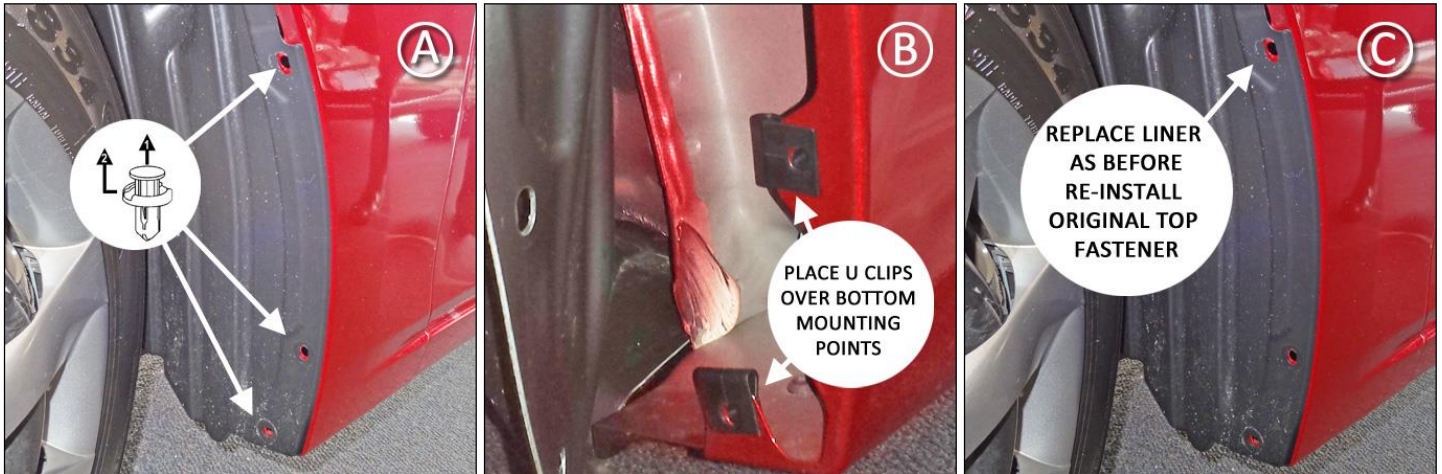

- **(Figure D)** Place the front bracket against the logo side of the flap, with upper stud through the top mounting hole. Bracket and flap assembly will align with the outer edge of the wheel well liner.
- **(Figure E)** Position the front mud flap with logo facing the rear of the vehicle with the bracket between flap and the outer edge of the liner. Using a standard screw (1SS) and a washer (SmWash), loosely bolt through the mud flap and into each of the two mounting points where the UClips have been installed. Carefully place a Locknut (SSLnut) with washer (SmWash), over the top mounting point, and secure the lower inside mounting point with the supplied insert (Ins3).
- **(Figure F)** Align outer edge of the flap by incrementally adjusting the assembly side to side, as well as the lower & upper portions of the flap. Check your adjustment, and confirming the flap is perpendicular to even ground. Tighten all mounting screws and nuts only until snug against washer. Do not over tighten the mounting screws or cross-thread the locknut.



Rear Mud Flap Installation

IMF31

- **(Figure G)** Removal of rear wheel is not necessary, but can ease installation. An alternative is to jack up the rear of the vehicle enough to lower the tire and enable access to the rear wheel well area. Remove the three fasteners from the inside of the upper rear wheel well area. (Large plastic inner nut, screw and fastener)
- **(Figure H)** Working from underneath the rear of the vehicle, remove the two wheel well liner bolts.
- **(Figure I)** Completely uninstall the liner. Place two UClips over each of the round mounting points.

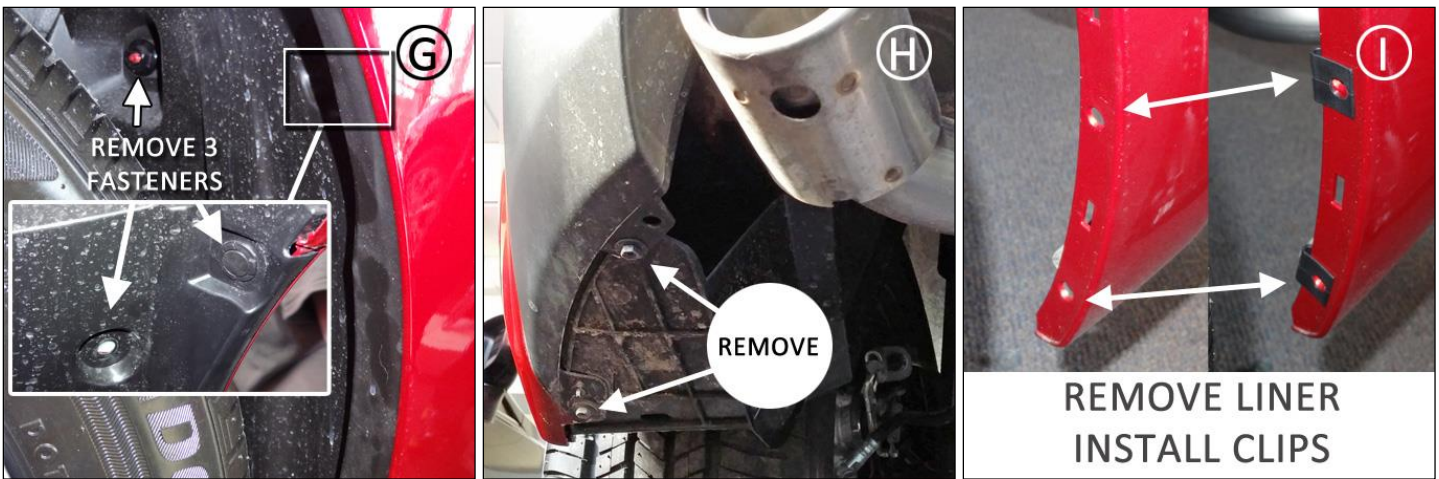

- **(Figure J)** ⚠️ This process can be best performed with the liner still installed on the vehicle (prior to installing the clips), using a marker, the existing holes on the bumper as a guide and marking them from underneath the rear of the bumper. Otherwise mark the mounting point locations as shown in the pictures below. High resolution images are available on www.rallyarmor.com. Note the bottom mounting point is **not exactly center of the "U" mark embedded on the liner**.

⚠️ BEST PERFORMED BY MARKING HOLE LOCATIONS WITH LINER STILL ON THE CAR ⚠️
⚠️ You must match the two existing mounting points found on the bumper behind liner. ⚠️

- **(Figure K)** Drill a small pilot hole in the exact center your marking left using a small bit (1/16" for example).
- **(Figure L)** Gradually expand the holes with a slightly bigger bit at a time until 1/4" hole is achieved. Reinstall liner and confirm inner holes on bumper are now visible through the liner. You can always expand the hole slightly bigger to confirm visibility of the inside mounting points.



- **(Figure M)** Mount the rear bracket to liner and bumper with the previously removed liner bolt placed through the slotted hole on the bracket. Do not fully tighten. Place UClip over the inside mounting point from the top. Flat side of clip towards front of vehicle.

IMF31

• **(Figure N)** Position the rear mud flap with logo facing the rear of the vehicle. Using a standard screw (1SS) and a washer (SmWash), loosely bolt the mud flap to the 2 outer mounting points. Secure inner rear mounting point with a small screw (.75SS) and a washer (SmWash) Push inside of the mud flap/bracket back until screw tip touches liner to ensure tire clearance .Do not fully tighten mounting points.

• **(Figure O)** Replace original upper fender liner fasteners and second unused bolt underneath **(Fig H)** Align outer edge of the flap by incrementally adjusting the side to side, lower/upper portion of the flap and walking away from the vehicle until the flap is perpendicular to even ground and mounting points are not visible from the outside/rear of vehicle. Tighten all mounting screws and nuts only until snug against washer. Do not overtighten.



2014+ MAZDA 3 INSTALLATION DIAGRAM

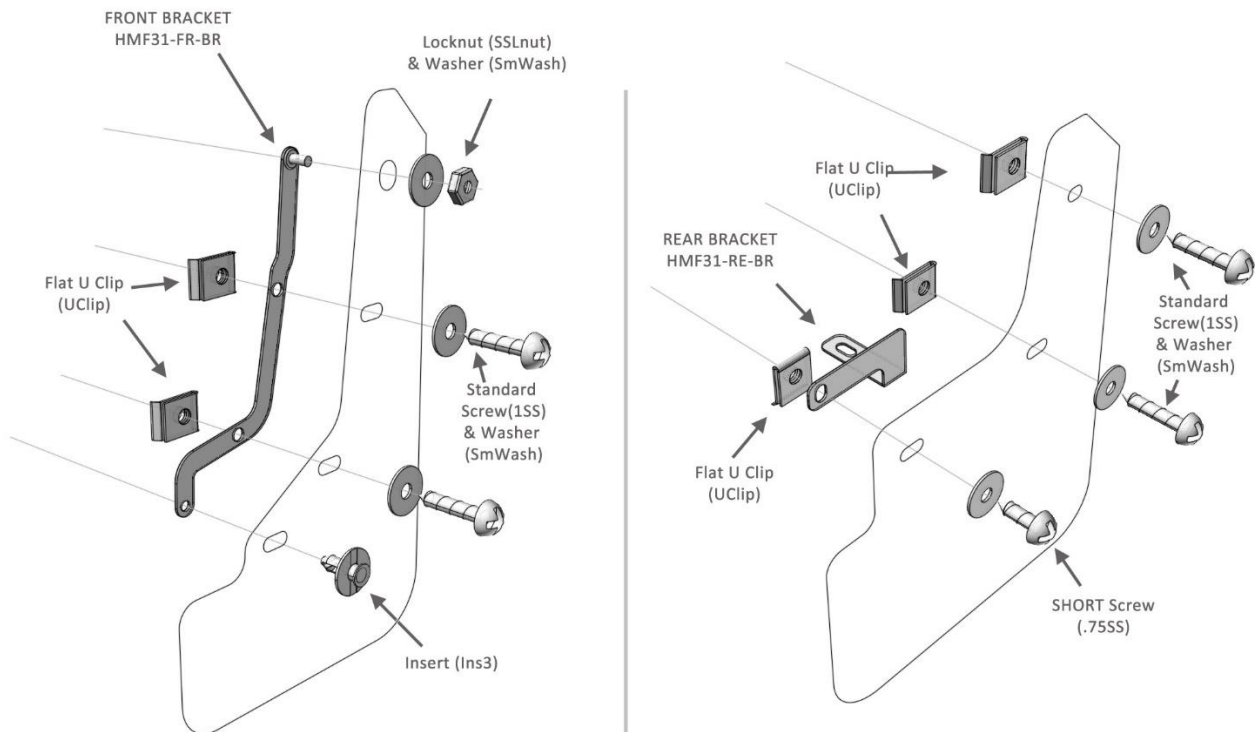

Check wheel clearance after installation, especially on vehicles outfitted with non-OEM offset wheels and suspensions. Adjust to accommodate accordingly in these scenarios. Rally Armor is not responsible for damage or loss of installed flaps.

All content included on these instructions is the copyright of Rally Armor® LLC