

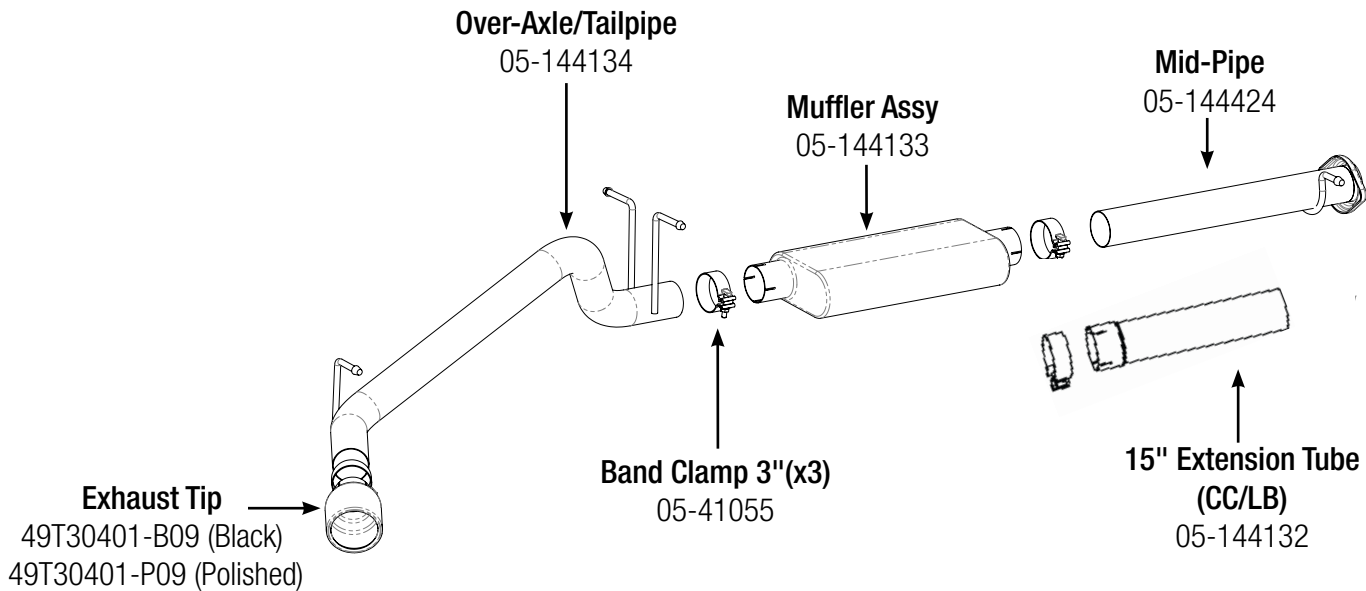

INSTALLATION INSTRUCTIONS

MAKE: GMC/Chevrolet
MODEL: Canyon/Colorado/ZR2
YEAR: 2015 - 2020
ENGINE: L4-2.5L/V6-3.6L
Fits: EC/LB & CC/SB-LB

3" Stainless Steel Cat-Back
49-44058-P (Polished)
49-44058-B (Black)



- Step 1:** (Read Instructions prior to installation) Secure Vehicle on jack stands (refer to manual for specified jack stand position) remove your stock exhaust up to the catalytic converter from the rear of your truck working your way forward. Take caution not to damage the factory hardware and isolation mounts as they will be reused. It is recommended to not fully tighten the clamps until the entire system has been installed.
- Step 2:** For faster installation spread the pieces of the exhaust alongside of your vehicle according to the diagram shown.
- Step 3:** For **CC/SB 128.3"** wheel base install the mid-pipe with the flange using the OE hardware and factory isolation mounts, Then slip on the provided 3" band clamp onto the muffler assembly and install muffler assembly onto mid-pipe and factory isolation mounts. For the **EC/LB 140.5"** wheel base install provided 3" band clamps and 15" extension tube onto mid-pipe assembly with the flange then install muffler assembly onto the extension tube and factory isolation mounts.
- Step 4:** Utilizing the factory isolation mounts now install over-axle/tailpipe and tip, Align exhaust system and tip to desired position and tighten all band clamps from front to rear.
- Step 9:** Your installation is now complete. It is recommended to re-tighten all exhaust components after 50-100 miles.

NOTES:

- aFe recommends that the tailpipe be at least 1/2" - 1" away from any body panels to avoid heat related body damage. **Tighten and secure.**

Caution: Allow time for your vehicle to cool down prior to installation. When working on or under your vehicle proceed with caution. Exhaust systems reach high temperatures and may cause serious burns. Wear protective safety equipment; eye goggles and gloves to ensure a safe installation. **aFe recommends professional installation on our products.**