

advanced FLOW engineering

Cold Air Intake System

Instruction Manual P/N: 56-10021D / 56-10021R

Make: Hyundai

Model: Veloster N

Year: 2019-2020

Engine: L4-2.0L(t)



- Please read the entire instruction manual before proceeding.
- Ensure all components listed are present.
- If you are missing any of the components, call customer support at 951-493-7100.
- Ensure you have all necessary tools before proceeding.
- Do not attempt to work on your vehicle when the engine is hot.
- Disconnect the negative battery terminal before proceeding.
- Retain factory parts for future use.

| Label | Qty. | Description | Part Number |
|-------|------|----------------------------|--------------|
| A1 | 1 | Air Filter (Pro 5R) | 24-91108 |
| A2 | 1 | Air Filter (Pro DRY S) | 21-91108 |
| B | 1 | Tube | 05-5670021B1 |
| C | 1 | Housing | 05-5610021B2 |
| D | 1 | Seal trim (27.5" Long) | 05-01534 |
| E | 1 | Coupling, Silicone Reducer | 05-01333 |
| F | 1 | Clamp, #044 | 03-50019 |
| G | 1 | Clamp, #048 | 03-50007 |
| H | 1 | Fitting, Aluminum 10mm | 03-50641 |
| I | 1 | Fitting, Aluminum 11mm | 03-50615 |
| J | 2 | Retainer Clips | 05-01350 |
| K | 1 | Threadlocker | 03-50162 |

Installation will require the following tools:

8mm and 10mm socket, extension, ratchet, 16mm wrench, pliers and flat-head screwdriver

Emissions Disclaimer: This product is not currently CARB exempt and is not available for purchase in California or for use on any vehicle registered with the California Department of Motor Vehicles.

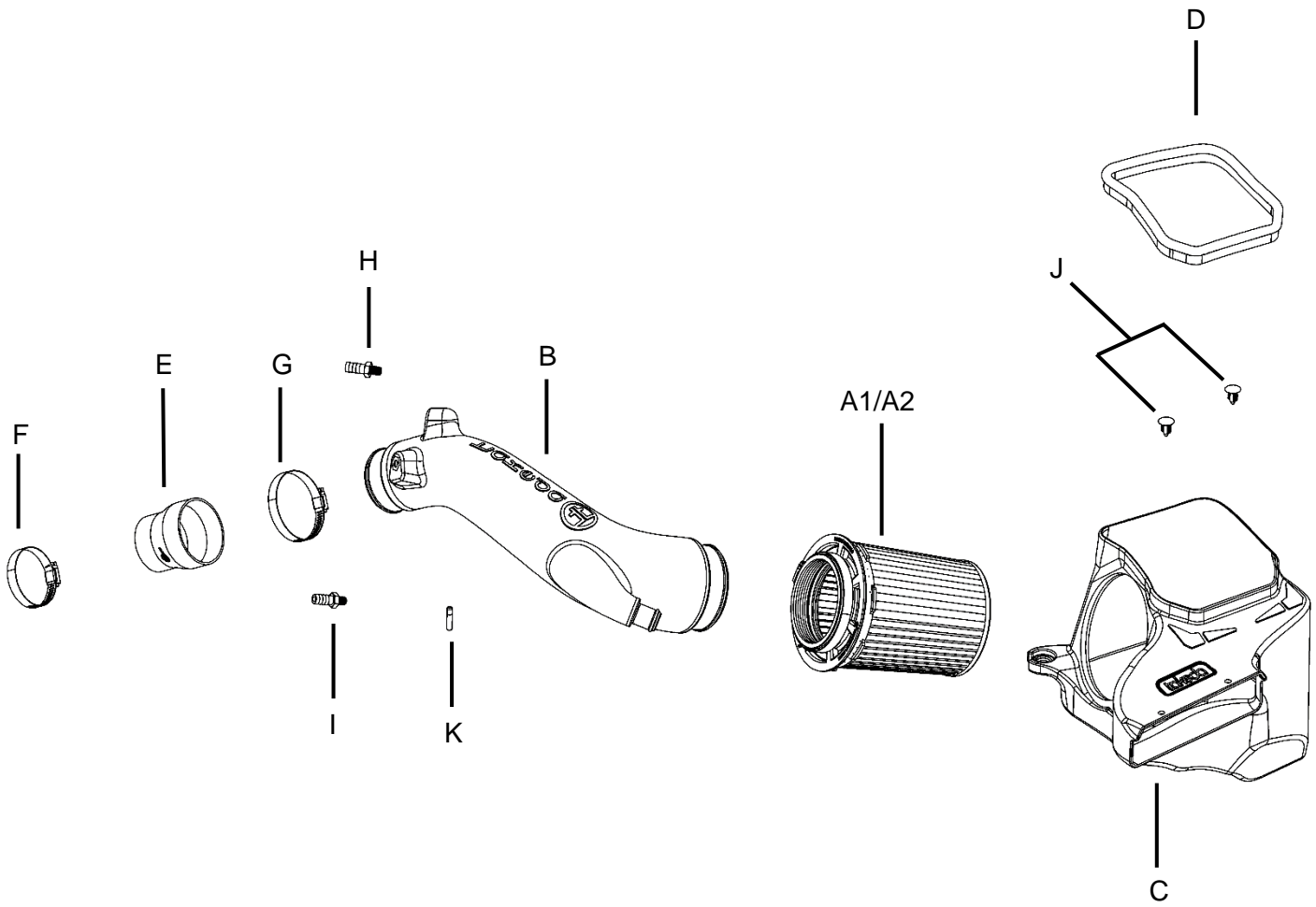



Refer to Figure A for Steps 1-4

Step 1: Remove the engine cover by pulling upward on it.

Step 2: Using pliers, open the clamp securing the hose to the air intake tube, and then slide the clamp away from the intake tube. This clamp will be re-used. Disconnect the rubber hose from the air intake tube.

Step 3: Loosen the clamp securing the factory intake tube to the factory air box.

**Figure B****Refer to Figure B for Step 4-6**

Step 4: Using pliers, open the clamps securing the small hoses to the air intake tube toward the firewall.

Slide the clamps away from the tube and disconnect the small rubber hoses from the intake tube. Those clamps will be re-used.

Step 5: Loosen the clamp at the turbo inlet using a 10mm socket and ratchet.

Step 6: Remove the factory intake tube from the vehicle.

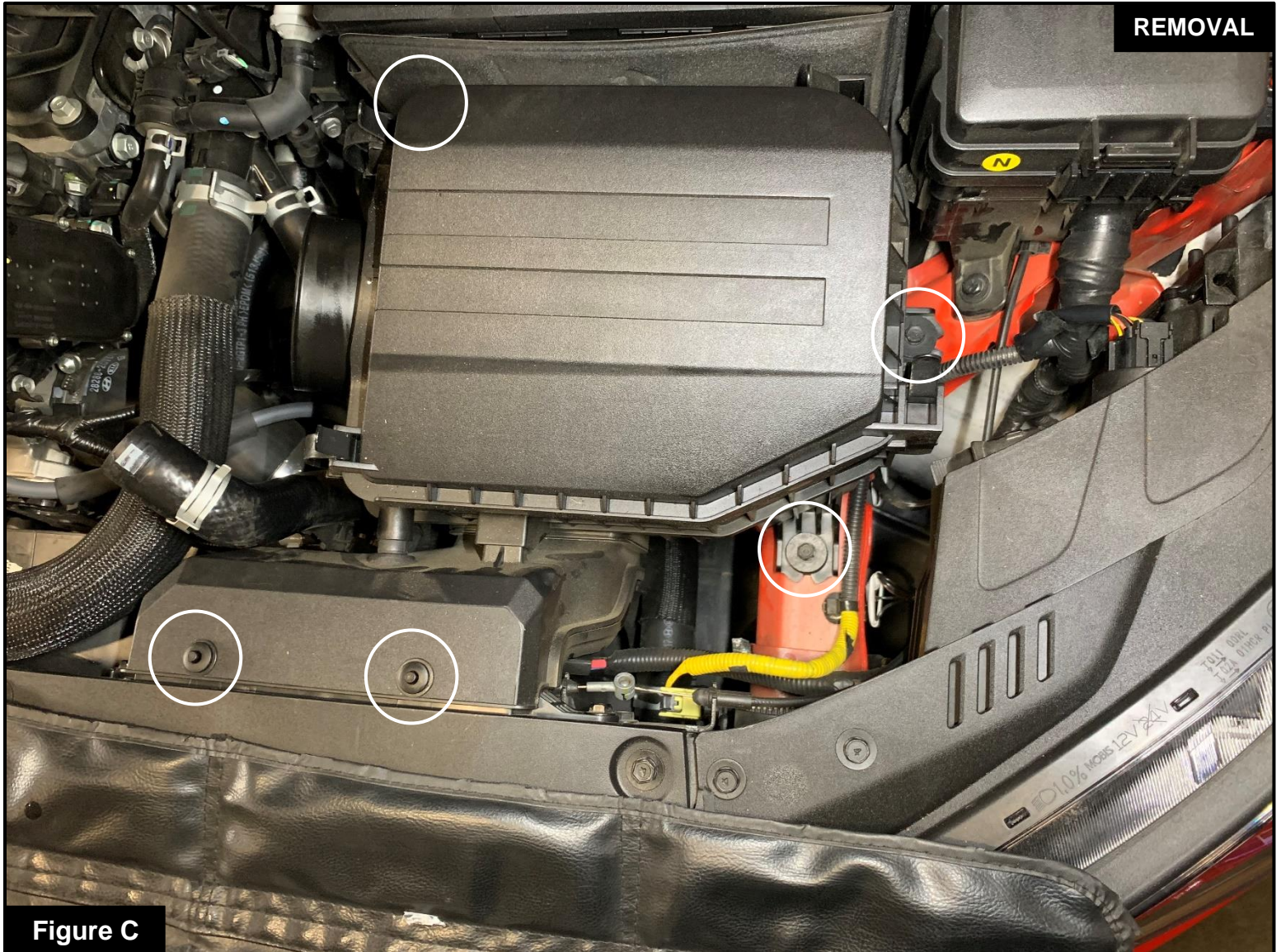

Figure C

Refer to Figure C for Steps 7-9

Step 7: Remove the two plastic rivets connecting the factory air inlet to the front of the car. Use a flat-head screwdriver to press down on the center of the rivet to unlock, and then pull them out. These plastic rivets will be replaced.

Step 8: With a 10mm socket, extension and ratchet, loosen the three bolts securing the factory housing to the vehicle. These three bolts will be re-used during the installation of the Takeda air intake system.

Step 9: Remove the bottom of the factory housing and air inlet as one piece out of the vehicle.

**Figure D****Refer to Figure D for Step 10**

Step 10: Transfer the three mounting grommets and sleeves from the bottom of the factory housing to the Takeda housing.



Figure E

Refer to Figure E for Step 11

Step 11: Install the provided seal trim around the top edges of the airbox.

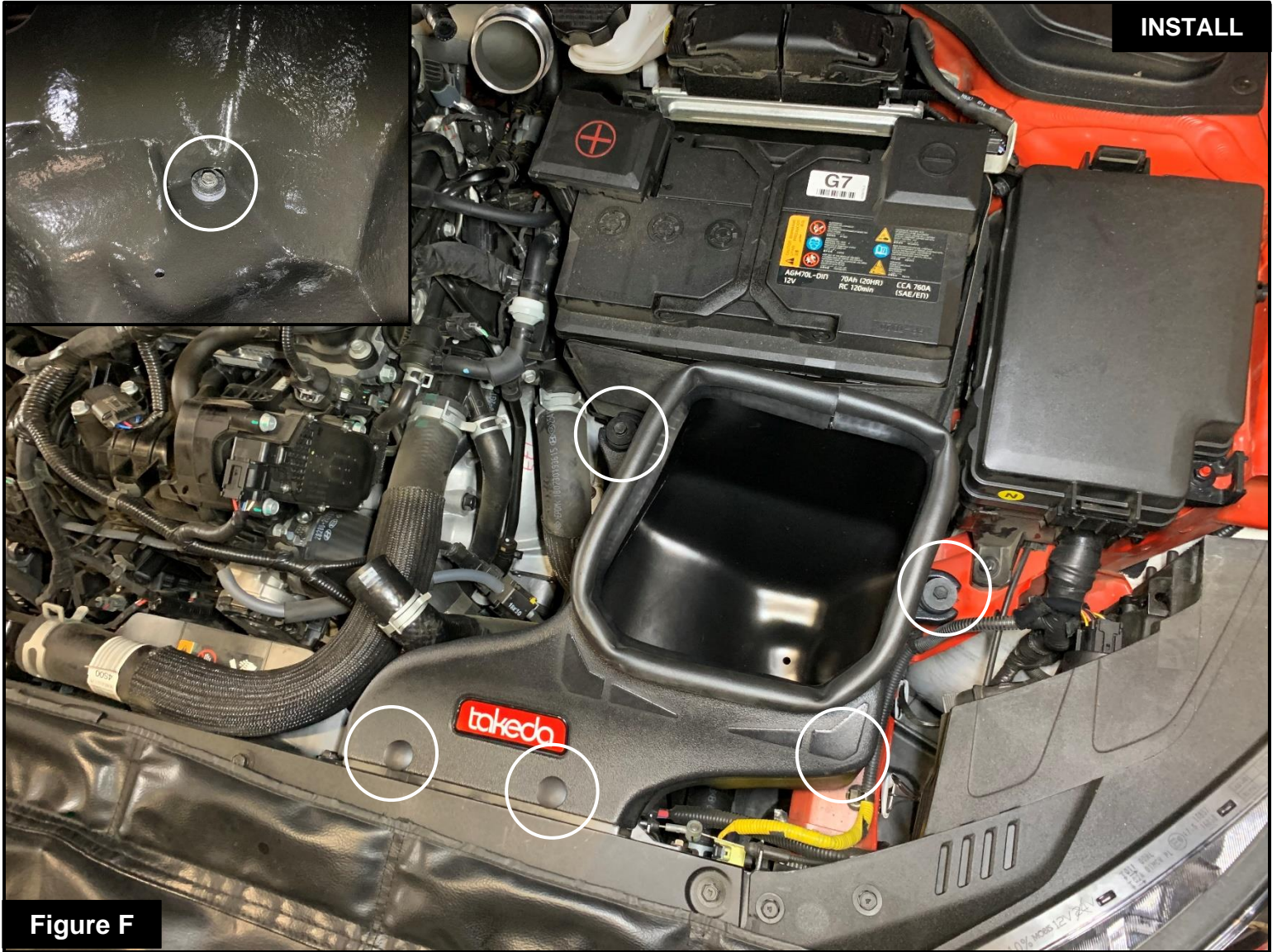
**Figure F****Refer to Figure F for Steps 12-13**

Step 12: Install the Takeda housing into the vehicle. Secure it with the three bolts removed at Step 8. One of the bolts will be installed inside the housing.

Step 13: Secure the housing to the air inlet with the two provided Christmas tree plastic rivets.



INSTALL

Figure G

Refer to Figure G for Step 14

Step 14: Install the air filter into the housing by firmly pushing it into the round opening of the housing until the filter tabs lock it into place. Install on the clamp on the filter, but do not tighten at this time.

**Smaller fitting
(with three ribs)**



**Bigger fitting
(with four ribs)**

Figure H

Refer to Figure H for Step 15

Step 15: Using a 16mm wrench, install the aluminum fittings into the Takeda air intake tube. Apply some of the provided threadlocker to guarantee a perfect seal. The two fittings are different. The bigger one (with four ribs) goes on the side of the tube. The smaller one (with three ribs) goes on the top of the tube.

Note: These are NPT fittings, the small gap between the 16mm hex and the tube is normal.

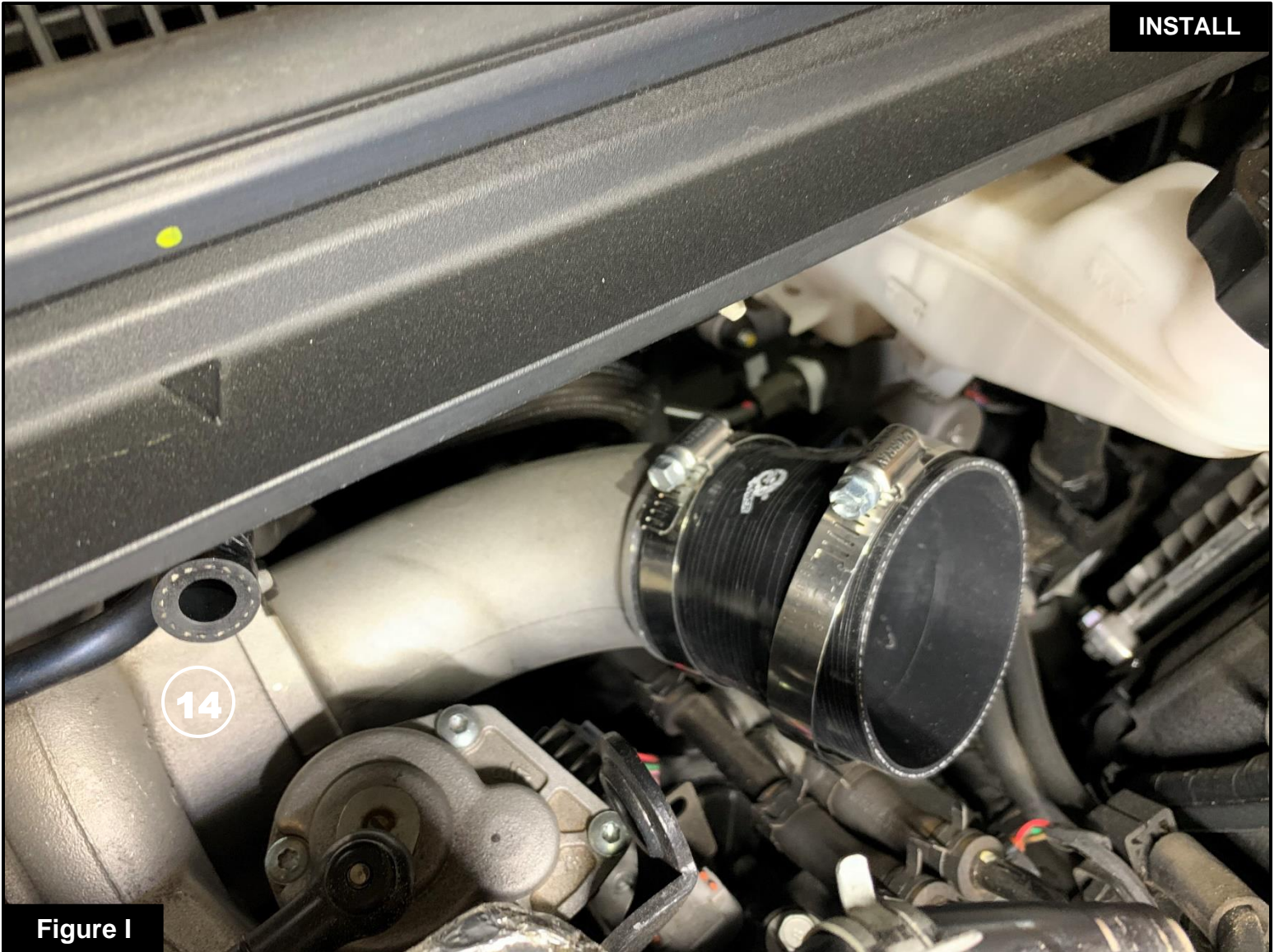
**Figure I****Refer to Figure I for Steps 16**

Step 16: Install the coupling onto the turbo inlet (the smaller end of the coupling goes onto the turbo inlet).
Install the provided clamps over the coupling, but do not tighten yet.

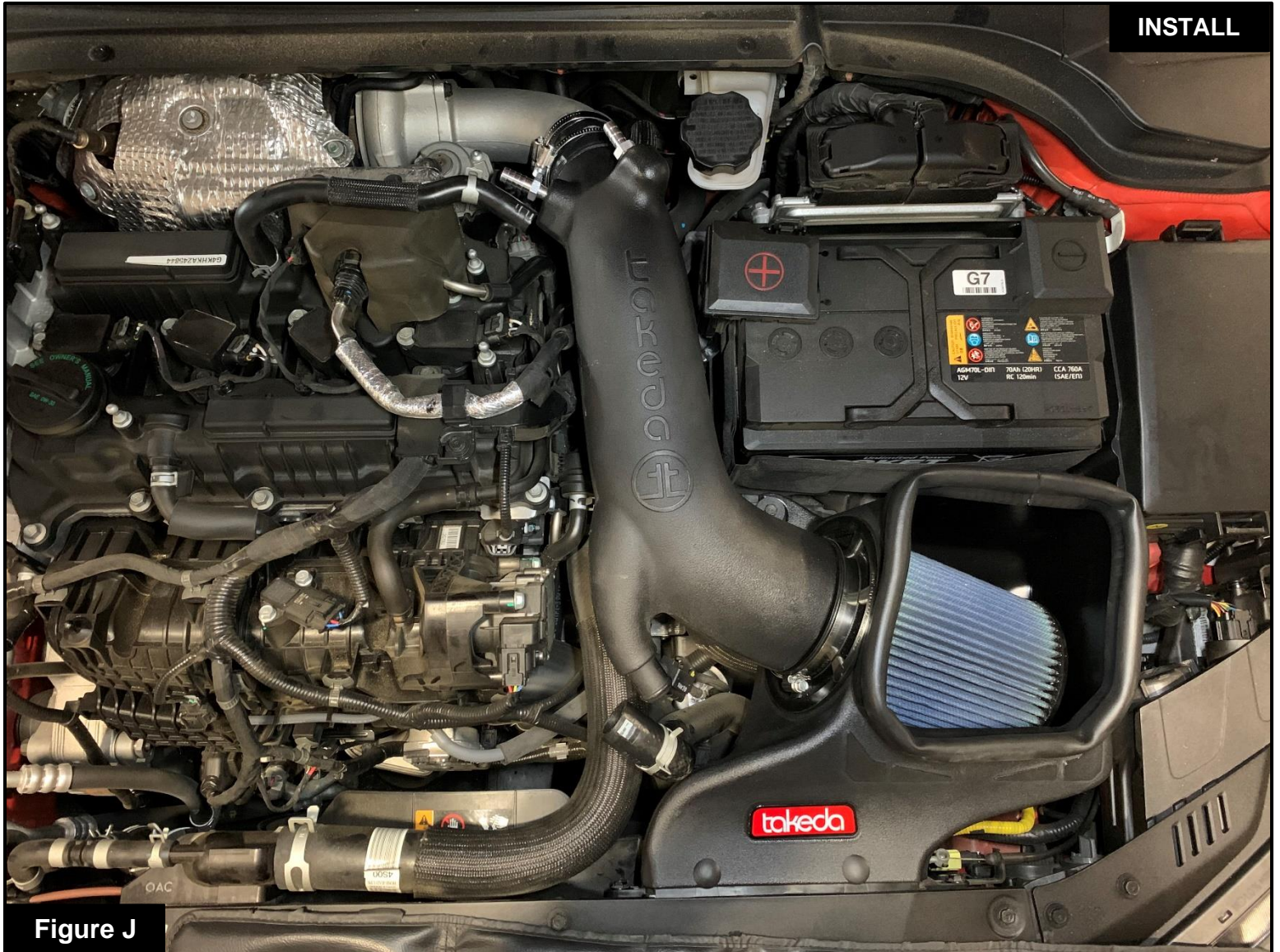
**Figure J****Refer to Figure J for Steps 17-18**

Step 17: Install the Takeda intake tube by sliding it into the coupling then into the air filter.

Step 18: Align the tube, filter and coupling then tighten all clamps.

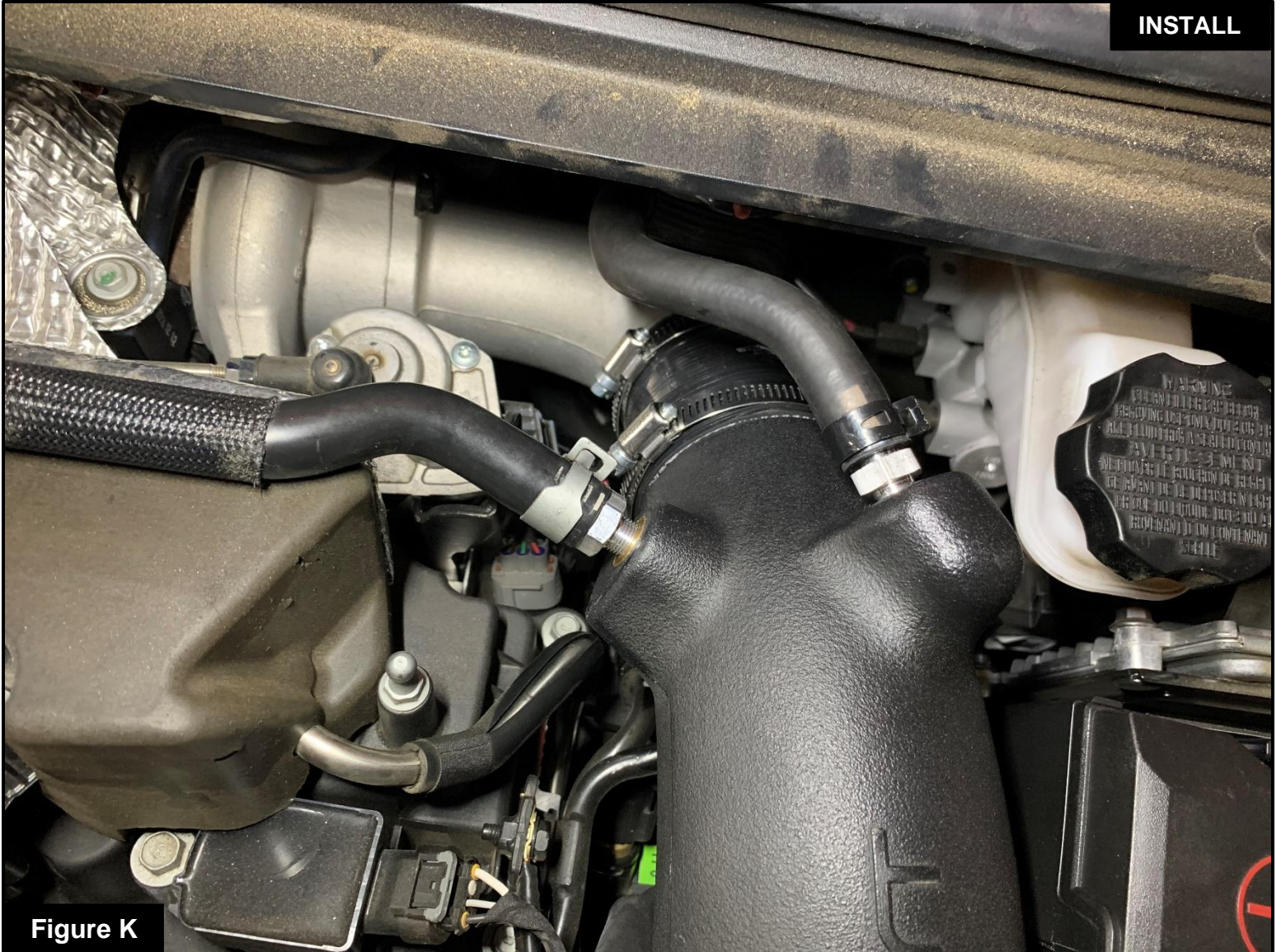
**Figure K****Refer to Figure K for Steps 19**

Step 19: Connect the small rubber hoses to the aluminum fitting on the tube. Secure them with the factory pry clamps.

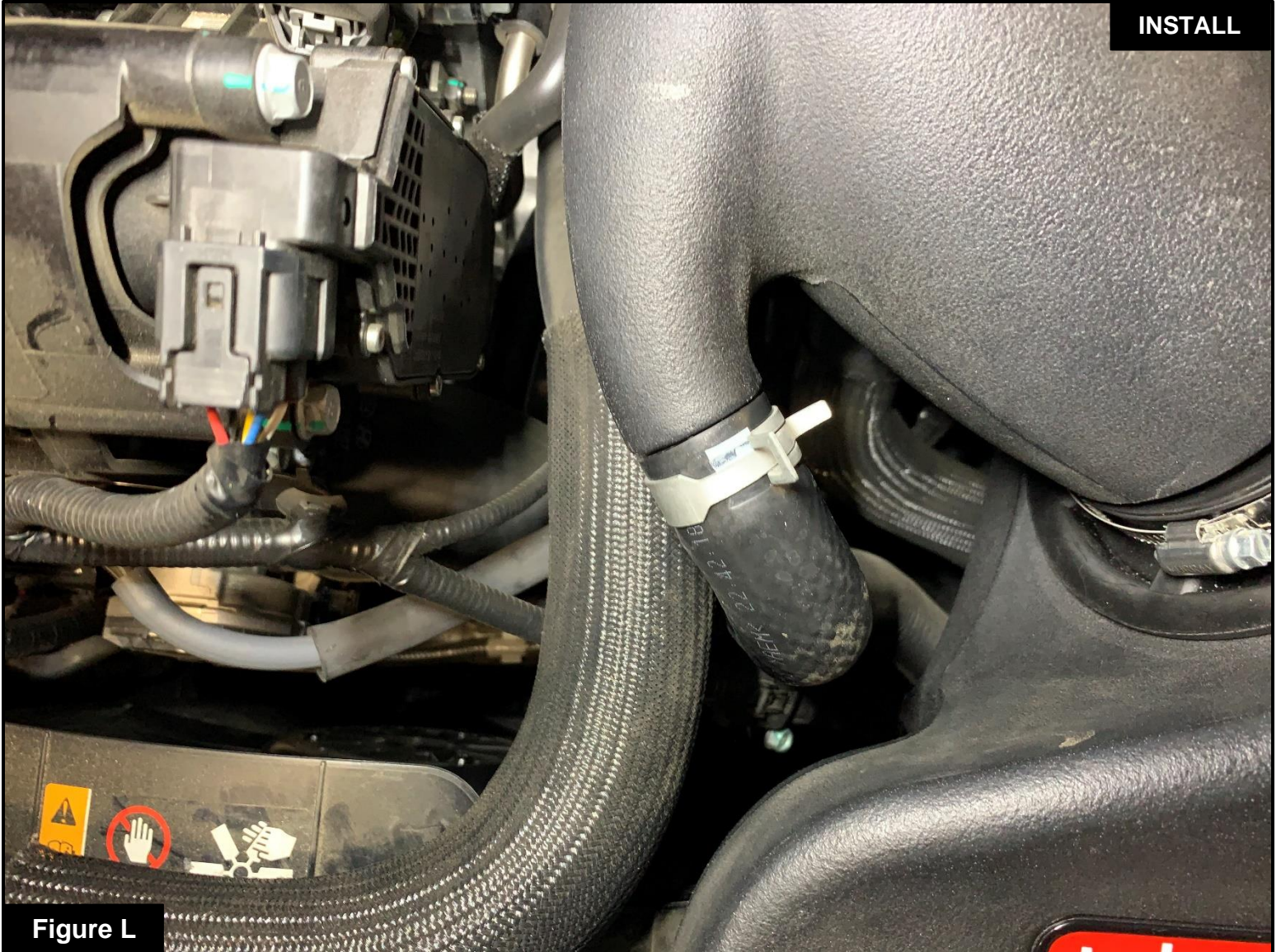
**Figure L****Refer to Figure L for Steps 20-21**

Step 20: Connect the bigger rubber hose to the Takeda air intake tube. Secure it with the factory pry clamp.

Step 21: Reinstall the engine cover.

**Figure M**

Refer to Figure M for Steps 22

Step 22: Make sure all clamps and connections are secured. Your installation is now complete. Thank you for choosing Takeda USA!

NOTE: Check all screws, clamps, and connectors are secure after 100-200 miles.



Page left blank intentionally



Pro DRY S Air Filter



P/N: 21-91108

Pro 5R Air Filter



P/N: 24-91108

Pre-Filter



P/N: 28-10113

Pro DRY S Restore Kit



P/N: 90-59999

Blue Squeeze Restore Kit



P/N: 90-50501

Tactical Backpack



P/N: 40-33205-B

Flashlight LED



P/N: 40-10202

Mechanic Gloves (L)



P/N: 40-10149

Scorcher GT Power Module



P/N: 77-47004

To purchase any of the items above, view airflow charts, dyno graphs, photos, and video; please go to aFepower.com.



Warranty

General Terms:

- aFe warrants their products to be free from manufacturer's defects due to workmanship and material.
- This warranty applies only to the original purchaser of the product and is non-transferrable.
- Proof of purchase of the aFe product is required for all warranty claims.
- Warranty is valid provided aFe instructions for installation and/or cleaning were properly followed.
- Proper maintenance with regular inspections of product is required to insure warranty coverage.
- Damage due to improper installation, abuse, unauthorized repair or alteration is not warranted.
- Incidental or consequential damages or cost, including installation and removal of part, incurred due to failure of aFe product is not covered under this warranty.
- All warranty is limited to the repair and/or replacement of the aFe part. To request Return Goods Authorization ("RGA"), email RGA@afepower.com or call (951)493-7100. Upon receipt of the RGA, you must return the product to the address provided in the RGA, freight prepaid and accompanied with a dated proof of purchase and the RGA. Upon receipt of the defective product and upon verification of proof of purchase, aFe will either repair or replace the defective product within a reasonable time, not to exceed thirty days.

| Product Category | P/N Prefix | Warranty duration |
|----------------------------------|--|---------------------|
| Direct OE Replacement Filters | 10, 11, 30, 31, 71, 73 | Life of the vehicle |
| Racing Filters | 18 | 1 year |
| Universal | 20, 21, 23, 24, 72, TF | 2 years |
| Air Intake Systems | 50, 51, 53, 54, 55, 56, 57, 58, 75, TR, TA, TL, TM | 2 years |
| Exhaust Systems | 49 | 2 years |
| Intercoolers & Intercooler Tubes | 46-2 | 2 years |
| Intake Manifolds | 46-1 | 2 years |
| Differential Cover | 46-7 | Life of the vehicle |
| Exhaust Manifolds | 46 | 2 years |
| Throttle Body Spacers | 46-3 | 2 years |
| Turbochargers | 46-6 | 2 years* |
| Fluid Filters | 44 | 90 days |
| Pre-Filters | 28 | 2 years |
| Heavy Duty OE Replacement | 70 | 2 years |
| PowerSports OE Replacement | 81, 87 | 2 years |
| PowerSports Intake Systems | 85 | 2 years |

No other warranty expressed or implied applies nor is any person or advanced FLOW engineering authorized to assume any other warranty. Some States do not allow the exclusion or limitation of incidental or consequential damages or do not allow limitations on how long an implied warranty lasts, so the above limitations or exclusions may not apply to you. This warranty gives you specific legal rights, and you may also have other rights which vary from State to State.

*See turbocharger warranty for more info



advanced FLOW engineering, inc.

252 Granite Street Corona, CA 92879
TEL: 951.493.7100 • TECH: 951.493.7134
E-Mail: Tech@aFepower.com

P/N: 06-81318