

advanced FLOW engineering

Cold Air Intake System

Instruction Manual P/N: 56-70024D / 56-70024R

Make: Hyundai

Model: Elantra

Year: 2016-2020

Engine: L4-2.0L



- Please read the entire instruction manual before proceeding.
- Ensure all components listed are present.
- If you are missing any of the components, call customer support at 951-493-7185.
- Ensure you have all necessary tools before proceeding.
- Do not attempt to work on your vehicle when the engine is hot.
- Retain factory parts for future use.

Label	Qty.	Description	Part Number
A1	1	Air Filter (Pro 5R)	24-91108
A2	1	Air Filter (Pro DRY S)	21-91108
B	1	Tube	05-5670024B1
C	1	Housing	05-5670005B2
D	1	Plug, Air Box	05-01482
E	1	Coupling, Silicone Bellows Reducer	05-01528
F	1	Clamp, #044	03-50019
G	1	Clamp, #048	03-50007
H	1	Fitting, Aluminum 11mm	03-50615
I	2	Retainer Clips	05-50616
J	1	Threadlocker	03-50162

Installation will require the following tools:

8mm and 10mm socket, extension, ratchet, 16mm wrench, pliers and flat-head screwdriver.

A safe way to lift the front of the vehicle may be necessary.

Emissions Disclaimer: This product is not currently CARB exempt and is not available for purchase in California or for use on any vehicle registered with the California Department of Motor Vehicles.

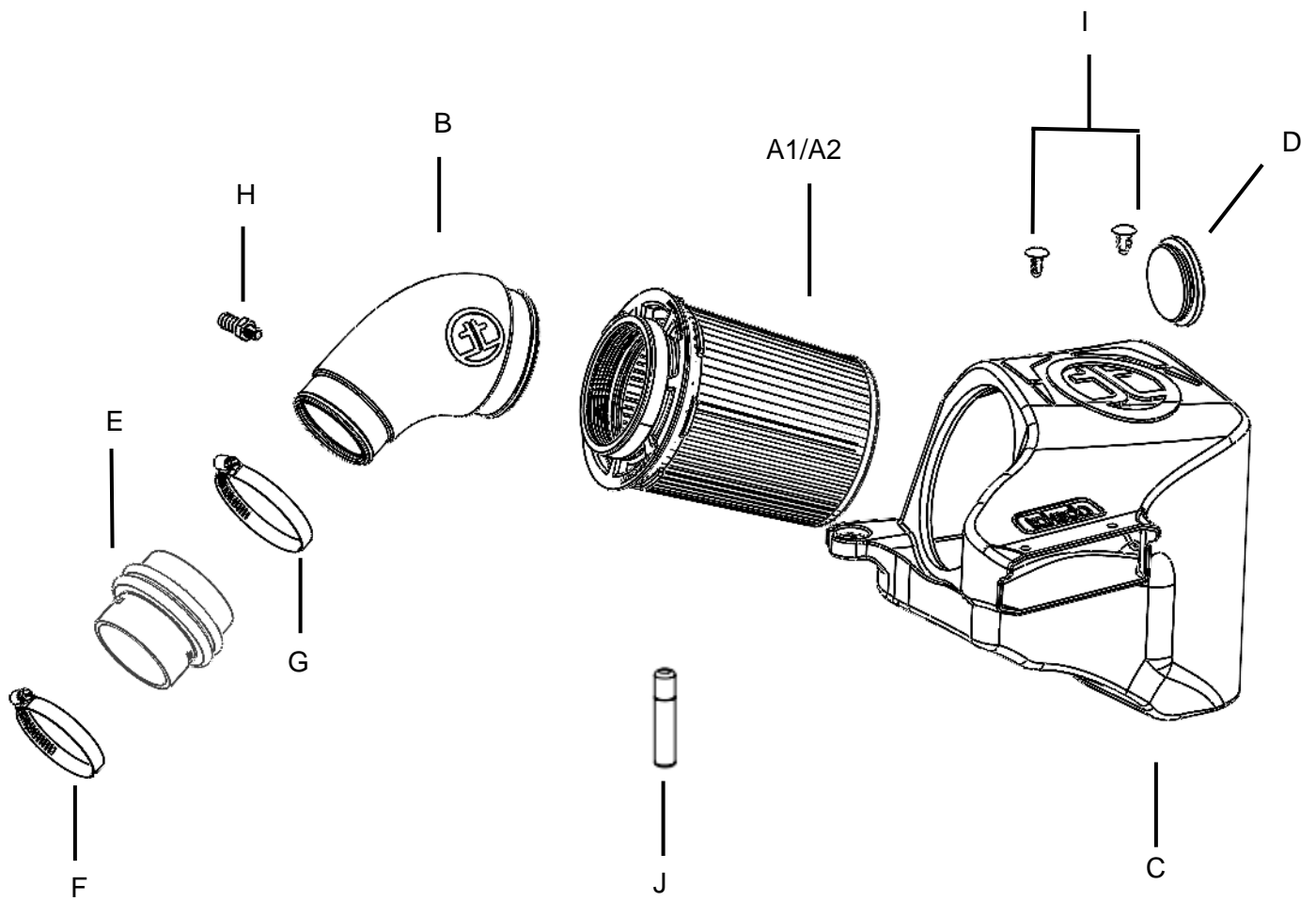

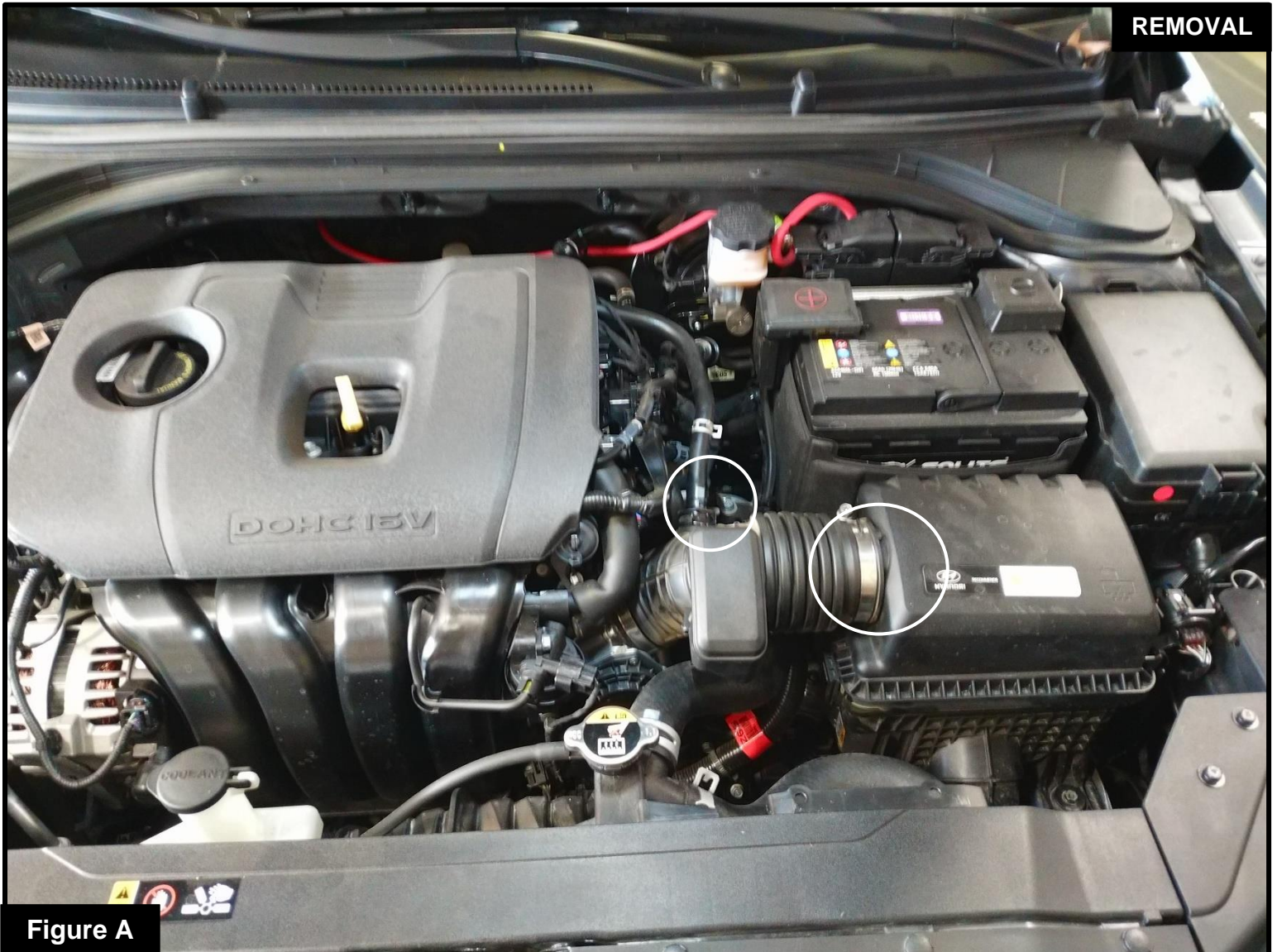
**Figure A****Refer to Figure A for Steps 1-3**

Step 1: Remove the engine cover by pulling upward on it.

Step 2: Using pliers, open the clamp securing the hose to the air intake tube, and then slide the clamp away from the intake tube. This clamp will be re-used. Disconnect the rubber hose from the air intake tube.

Step 3: Loosen the clamp securing the factory intake tube to the factory air box.

**Figure B****Refer to Figure B for Step 4-5**

Step 4: Using an 8mm socket, loosen the clamp that is over the throttle body

Step 5: Remove the factory intake tube from the vehicle.

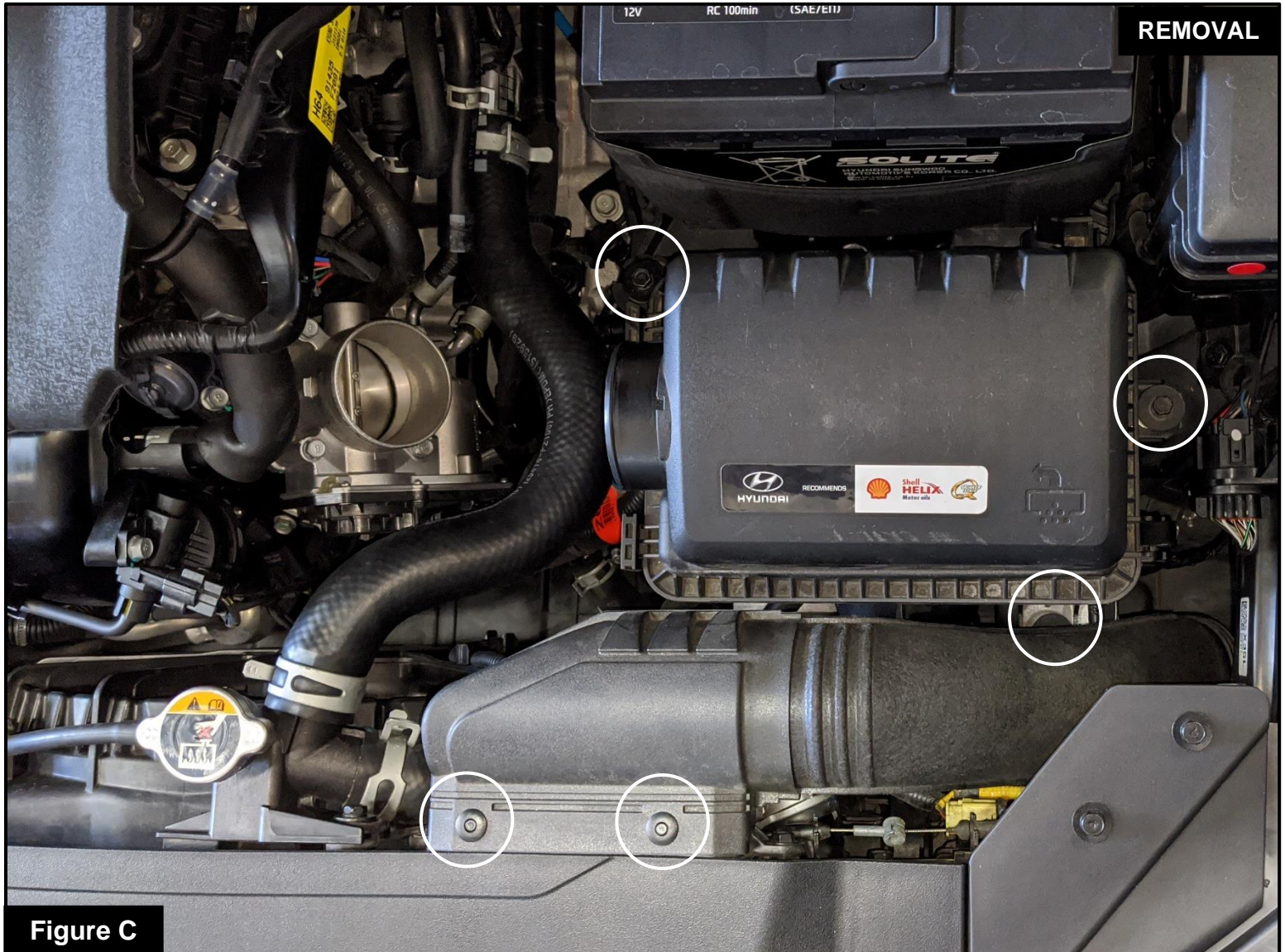

Figure C

Refer to Figure C for Steps 6-7

Step 6: Remove the two plastic rivets connecting the factory air inlet to the front of the car. Use a flat-head screwdriver to press down on the center of the rivet to unlock, and then pull them out. These plastic rivets will be replaced.

Step 7: With a 10mm socket, extension and ratchet, loosen the three bolts securing the factory housing to the vehicle. These three bolts will be re-used during the installation of the Takeda air intake system.



Figure D

Refer to Figure D for Step 8

Step 8: Remove the splash shield under the vehicle. There are twelve clips (circles) and seven 10mm screws (squares).

**Figure E****Refer to Figure E for Steps 9-10**

Step 9: Remove the lower portion of the factory air intake system. There are three 10mm screws holding it in place. Remove from underneath the vehicle.

Step 10: Reinstall splash shield.

**Figure F****Refer to Figure F for Step 11**

Step 11: Transfer the three mounting grommets and sleeves from the bottom of the factory housing to the Takeda housing.

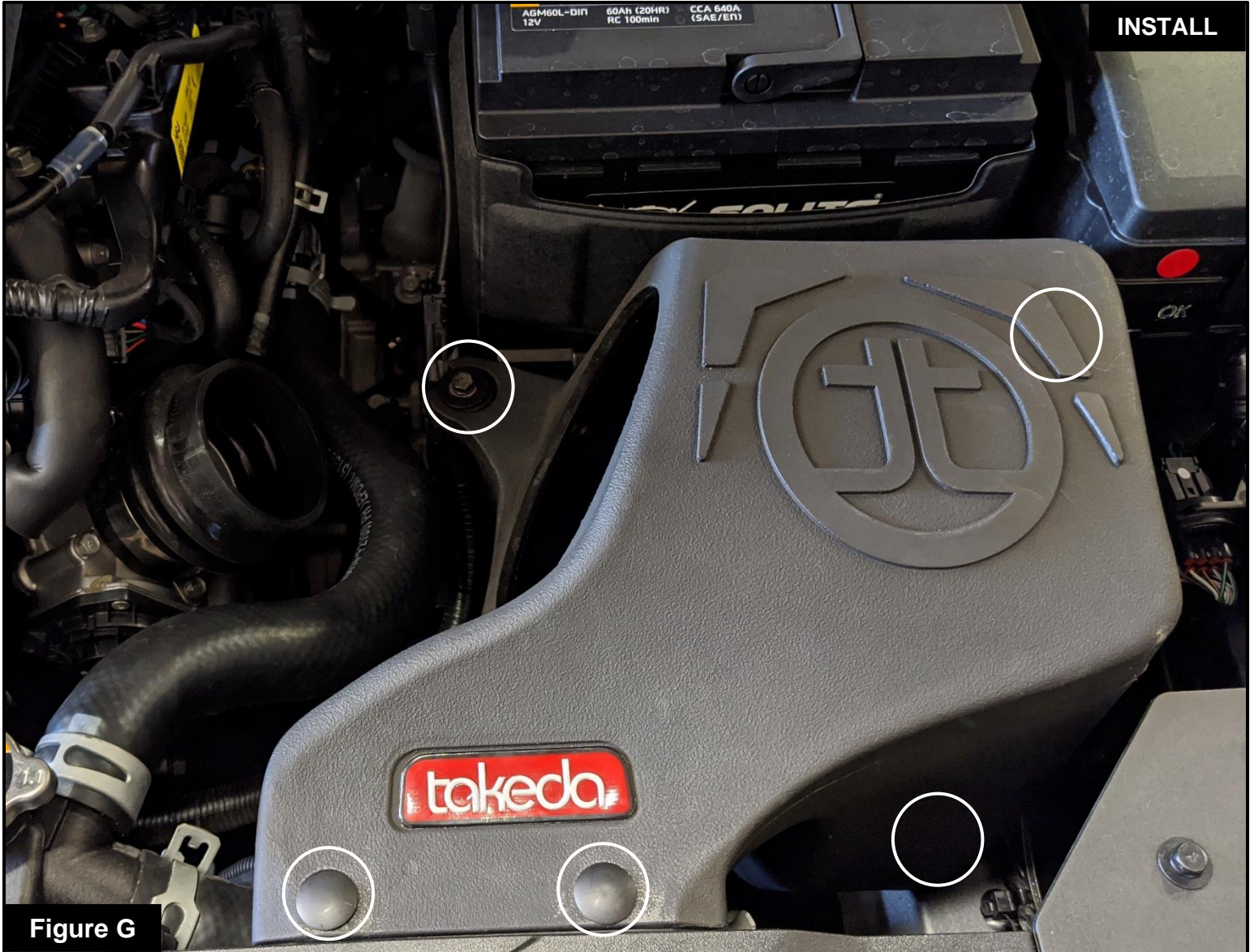

Figure G

Refer to Figure G for Steps 12-14

Step 12: Install the Takeda housing into the vehicle. Secure it with the three bolts removed at Step 8. One of the bolts will be installed inside the housing.

Step 13: Secure the housing to the air inlet with the two provided Christmas tree plastic rivets.

Step 14: Install the bellows coupling onto the throttle body. The smaller end of the coupler goes over the throttle body. Install the provided clamps over the throttle body, but do not tighten yet.



Figure H

Refer to Figure H for Step 15

Step 15: Install the air filter into the housing by firmly pushing it into the housing until the filter tabs lock it into place. Install on the clamp on the filter, but do not tighten at this time.

**Figure I****Refer to Figure I for Step 16**

Step 16: Using a 16mm wrench, install the aluminum fitting into the Takeda air intake tube. Apply some of the provided threadlocker to guarantee a perfect seal.

Note: These are NPT fittings, the small gap between the 16mm hex and the tube is normal.

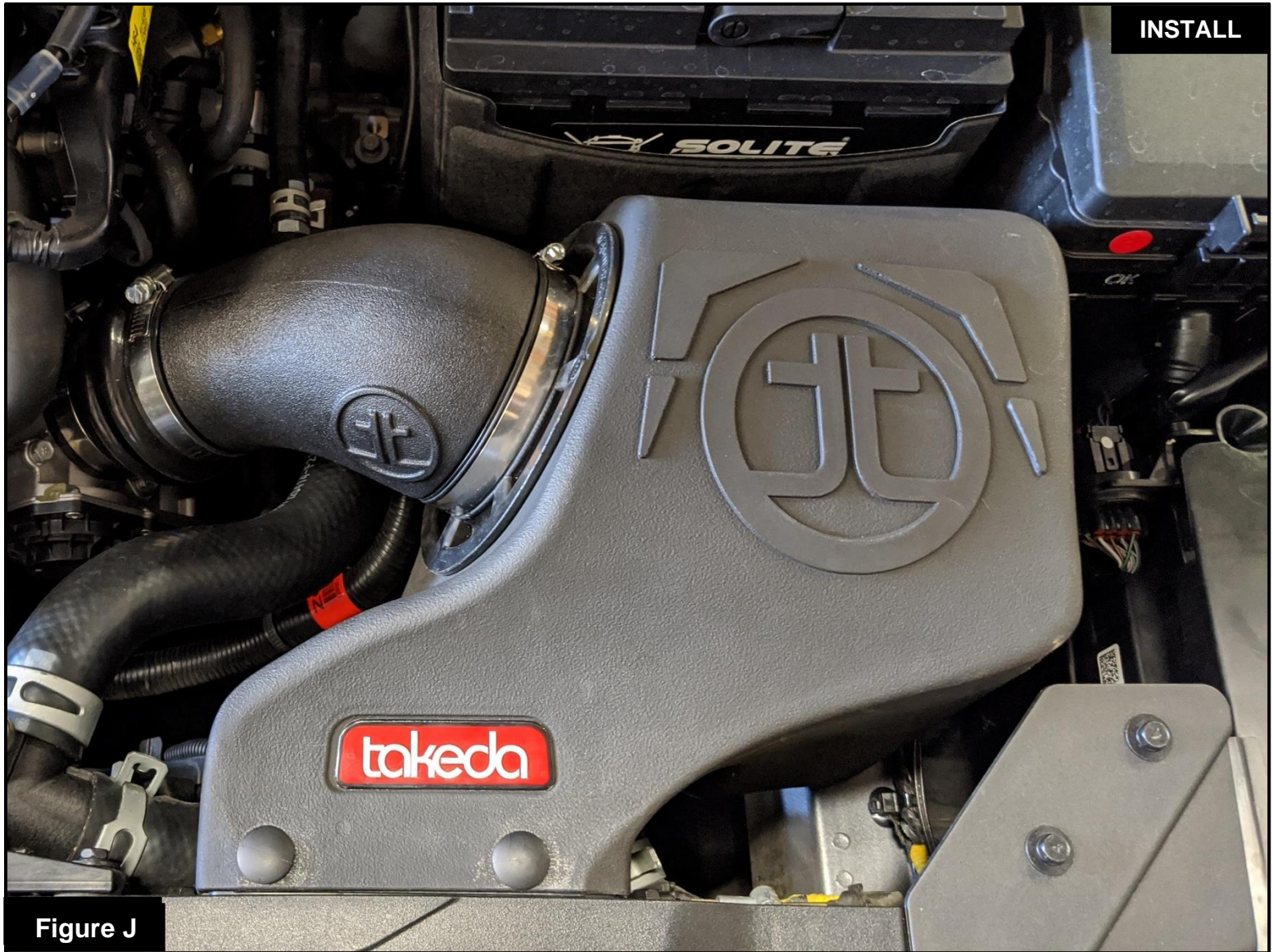

Refer to Figure J for Steps 17-18

Step 17: Install the Takeda intake tube by sliding it into the coupling then into the air filter.

Step 18: Align the tube, filter, and coupling, then tighten all clamps.

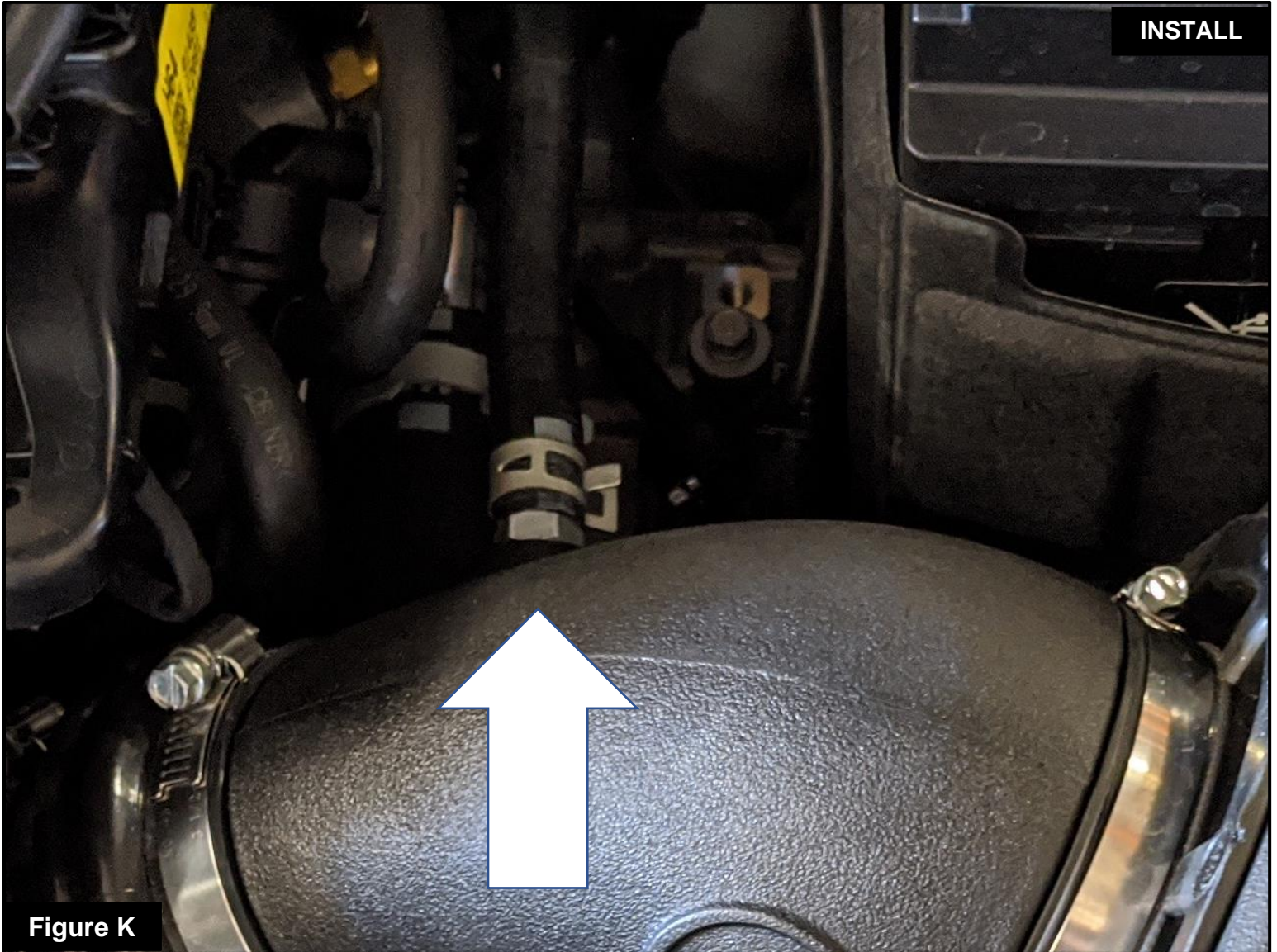

Figure K

Refer to Figure K for Step 19

Step 19: Connect the small rubber hose to the aluminum fitting on the tube. Secure them with the factory pry clamps.

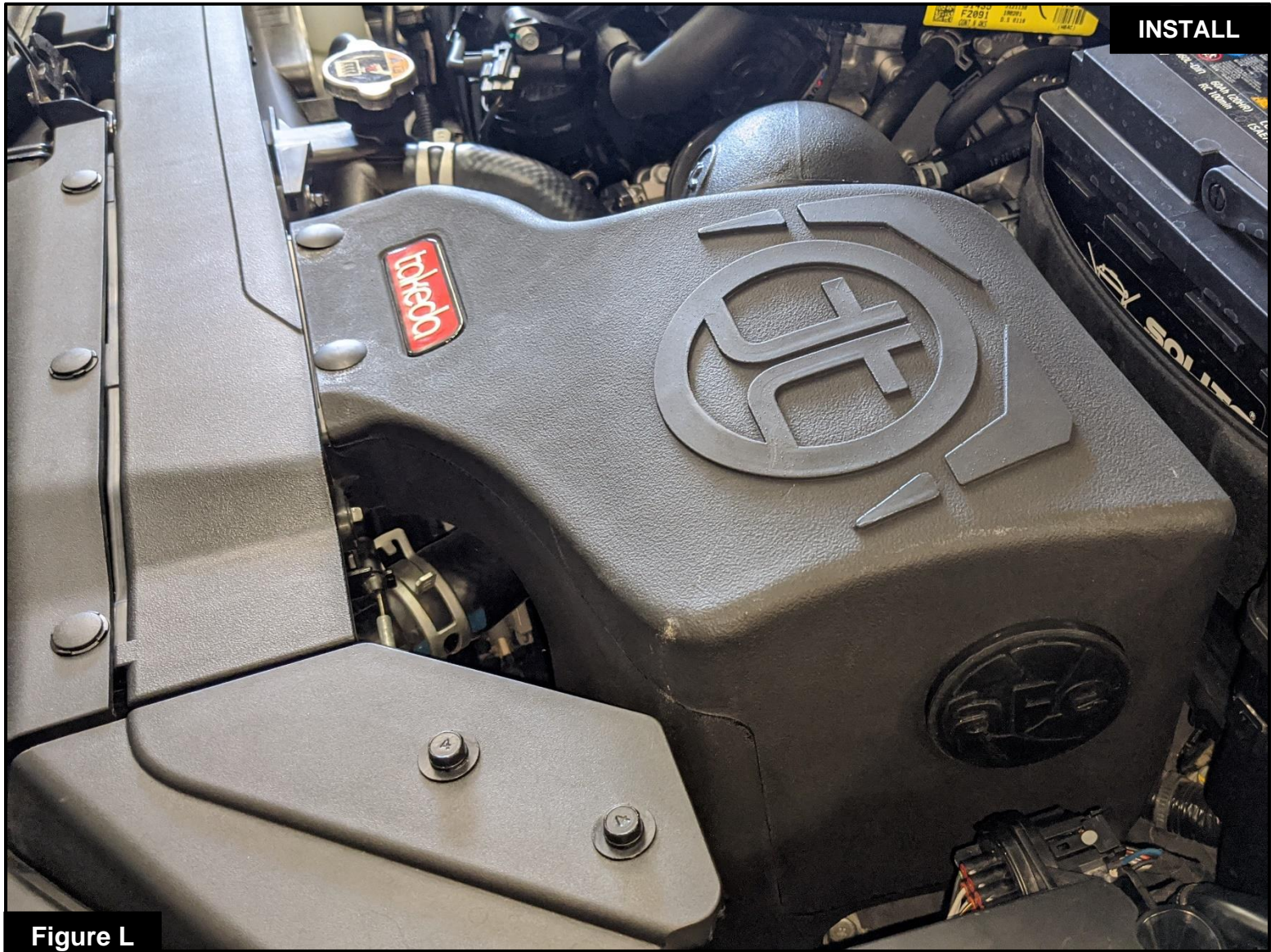

Figure L

Refer to Figure L for Step 20

Step 20: The kit includes an optional plug to close off the side auxiliary air inlet. Install the plug if you wish to close off the side auxiliary air inlet and only capture cold air from the front.

- Without the plug installed, the Takeda intake will capture the maximum air available. More airflow offers more power. Yet some of this air is picked up from inside the engine compartment and could be warmer air. Warmer air will affect the performance of the vehicle.
- The plug installed on the housing will block off any hot engine air entering the housing and make sure the coolest air available is directed into the engine. It will also reduce the noise of the intake.

**Figure M****Refer to Figure M for Steps 21-22**

Step 21: Reinstall Engine Cover.

Step 22: Make sure all clamps and connections are secured. Your installation is now complete. Thank you for choosing Takeda USA!

NOTE: Check all screws, clamps, and connectors are secure after 100-200 miles.



Page left blank intentionally

Pro DRY S Air Filter



P/N: 21-91108

Pro 5R Air Filter



P/N: 24-91108

Pre-Filter



P/N: 28-10113

Pro DRY S Restore Kit



P/N: 90-59999

Blue Squeeze Restore Kit



P/N: 90-50501

Tactical Backpack



P/N: 40-33205-B

Flashlight LED



P/N: 40-10202

Mechanic Gloves (L)



P/N: 40-10149

To purchase any of the items above, view airflow charts, dyno graphs, photos, and video; please go to aFepower.com.



Warranty

General Terms:

- aFe warrants their products to be free from manufacturer's defects due to workmanship and material.
- This warranty applies only to the original purchaser of the product and is non-transferrable.
- Proof of purchase of the aFe product is required for all warranty claims.
- Warranty is valid provided aFe instructions for installation and/or cleaning were properly followed.
- Proper maintenance with regular inspections of product is required to insure warranty coverage.
- Damage due to improper installation, abuse, unauthorized repair or alteration is not warranted.
- Incidental or consequential damages or cost, including installation and removal of part, incurred due to failure of aFe product is not covered under this warranty.
- All warranty is limited to the repair and/or replacement of the aFe part. To request Return Goods Authorization ("RGA"), email RGA@afepower.com or call (951)493-7100. Upon receipt of the RGA, you must return the product to the address provided in the RGA, freight prepaid and accompanied with a dated proof of purchase and the RGA. Upon receipt of the defective product and upon verification of proof of purchase, aFe will either repair or replace the defective product within a reasonable time, not to exceed thirty days.

Product Category	P/N Prefix	Warranty duration
Direct OE Replacement Filters	10, 11, 30, 31, 71, 73	Life of the vehicle
Racing Filters	18	1 year
Universal	20, 21, 23, 24, 72, TF	2 years
Air Intake Systems	50, 51, 53, 54, 55, 56, 57, 58, 75, TR, TA, TL, TM	2 years
Exhaust Systems	49	2 years
Intercoolers & Intercooler Tubes	46-2	2 years
Intake Manifolds	46-1	2 years
Differential Cover	46-7	Life of the vehicle
Exhaust Manifolds	46	2 years
Throttle Body Spacers	46-3	2 years
Turbochargers	46-6	2 years*
Fluid Filters	44	90 days
Pre-Filters	28	2 years
Heavy Duty OE Replacement	70	2 years
PowerSports OE Replacement	81, 87	2 years
PowerSports Intake Systems	85	2 years

No other warranty expressed or implied applies nor is any person or advanced FLOW engineering authorized to assume any other warranty. Some States do not allow the exclusion or limitation of incidental or consequential damages or do not allow limitations on how long an implied warranty lasts, so the above limitations or exclusions may not apply to you. This warranty gives you specific legal rights, and you may also have other rights which vary from State to State.

*See turbocharger warranty for more info



advanced FLOW engineering, inc.

252 Granite Street Corona, CA 92879
TEL: 951.493.7100 • TECH: 951.493.7185
E-Mail: Tech@aFepower.com

P/N: 06-81328