

| | | | |
|---|------------|-----------------------------|------------|
| Einbauhinweise / Installation Instructions | | <i>KW automotive</i> | |
| Hinweis Nr./ Instruction No. | 685 10 117 | Erstellt am/ Date | 29.07.2010 |

KW automotive

**685 10 117
EINBAUHINWEISE
BMW M5 Typ M560 Elektronik Satz**

**685 10 117
INSTALLATION INSTRUCTIONS
BMW M5 type M560 Cancellation kit**

| | | | | |
|---|------------|--|----------------------|------------|
| Einbauhinweise / Installation Instructions | | | KW automotive | |
| Hinweis Nr./ Instruction No. | 685 10 117 | | Erstellt am/ Date | 29.07.2010 |

**Vorderachse/
Front axle:**



Montageort VA Elektronik Satz / Assembly area front axle electronic kit

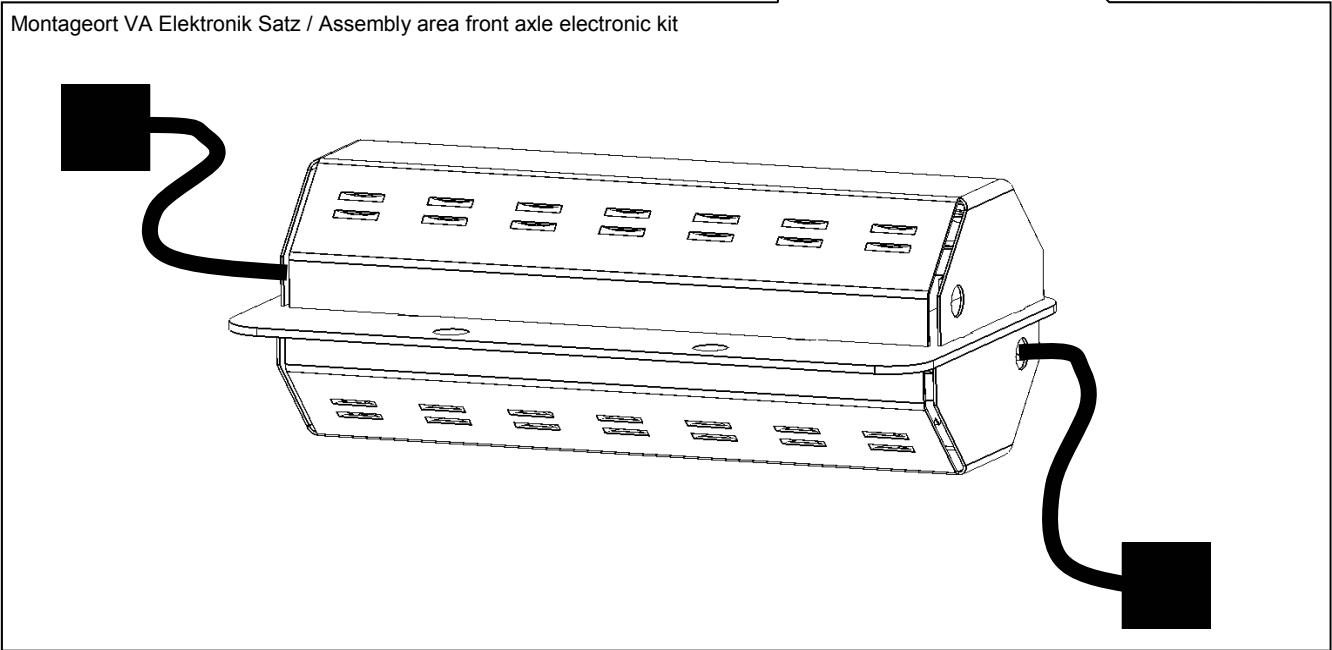

| | | | |
|---|------------|----------------------|------------|
| Einbauhinweise / Installation Instructions | | KW automotive | |
| Hinweis Nr./ Instruction No. | 685 10 117 | Erstellt am/ Date | 29.07.2010 |

**Vorderachse/
Front axle:**

VA Elektronik Satz am vorderen Träger mittig zum Fahrzeug anlegen und Bohrungen markieren. Anschließend markierte Stellen durchbohren (Ø 9 mm) und die mitgelieferten Einnietmuttern einnieten.
ACHTUNG: Vor dem Bohren müssen die Kabel unter dem Träger entfernt werden!

Please set the front axle electrical set centered onto the front hood lock support / hood latch of the car and mark the drilling points. After marking the spots with an X please use a 9 mm drill to drill the holes. Then rivet the supplied rivetting nut into the holes.

IMPORTANT: Please make sure to detach the electrical wires below the front hood lock support / hood latch.

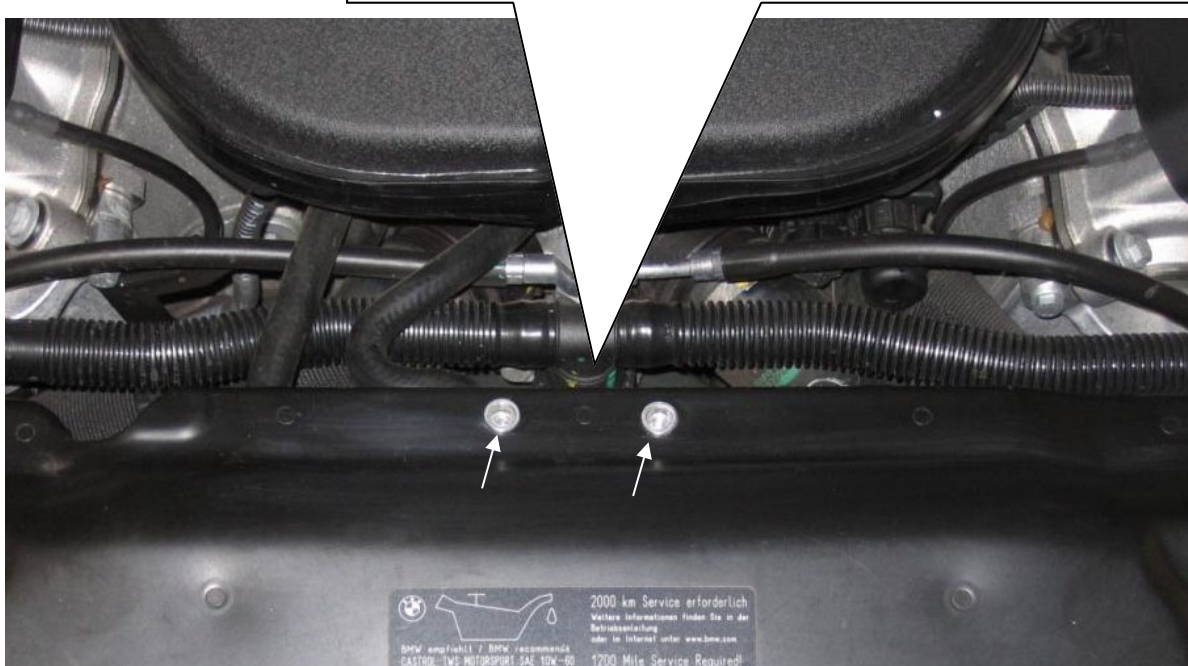

VORSICHT KABEL
ATTENTION CABLES

| | | | | |
|---|------------|--|----------------------|------------|
| Einbauhinweise / Installation Instructions | | | KW automotive | |
| Hinweis Nr./ Instruction No. | 685 10 117 | | Erstellt am/ Date | 29.07.2010 |

**Vorderachse/
Front axle:**

VA Elektronik Satz mit den mitgelieferten Schrauben montieren.
Fix the electronic kit with the supplied screws.

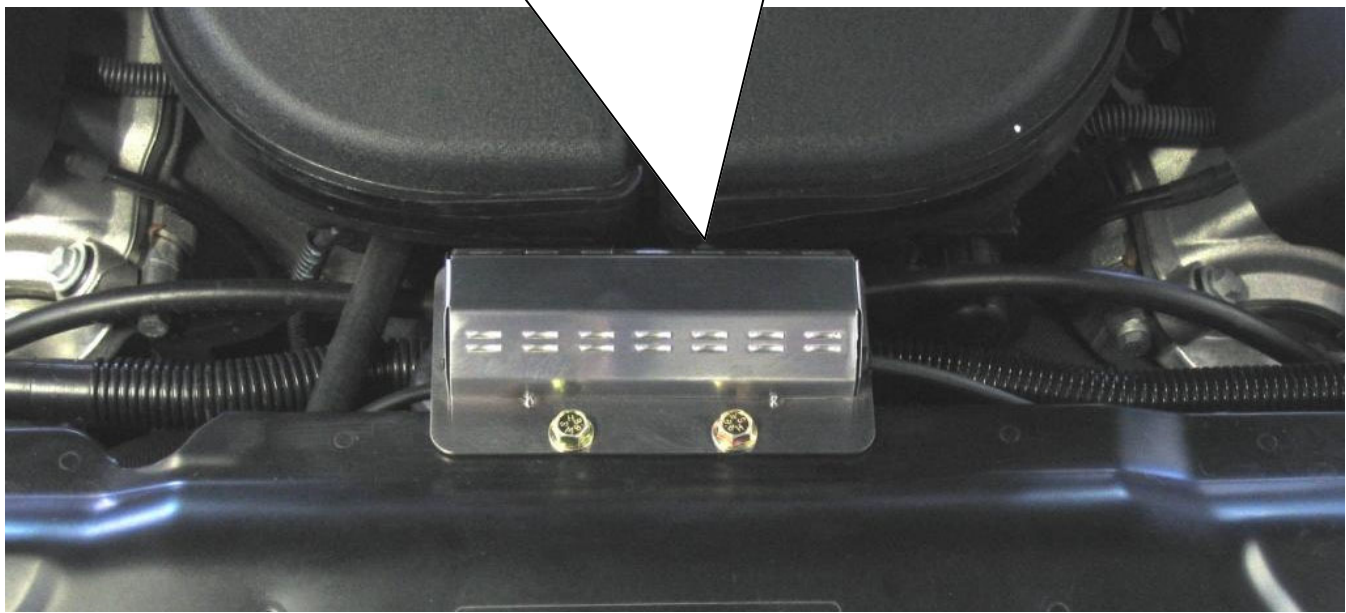

VA Elektronik Satz mit dem Original Kabelbaum verbinden. Anschließen Kabel verlegen und an den markierten punkten mit Kabelbinder befestigen.
Connect the electronic kit with the original cable harness and fix the cable with the supplied cable ties on the marked points.

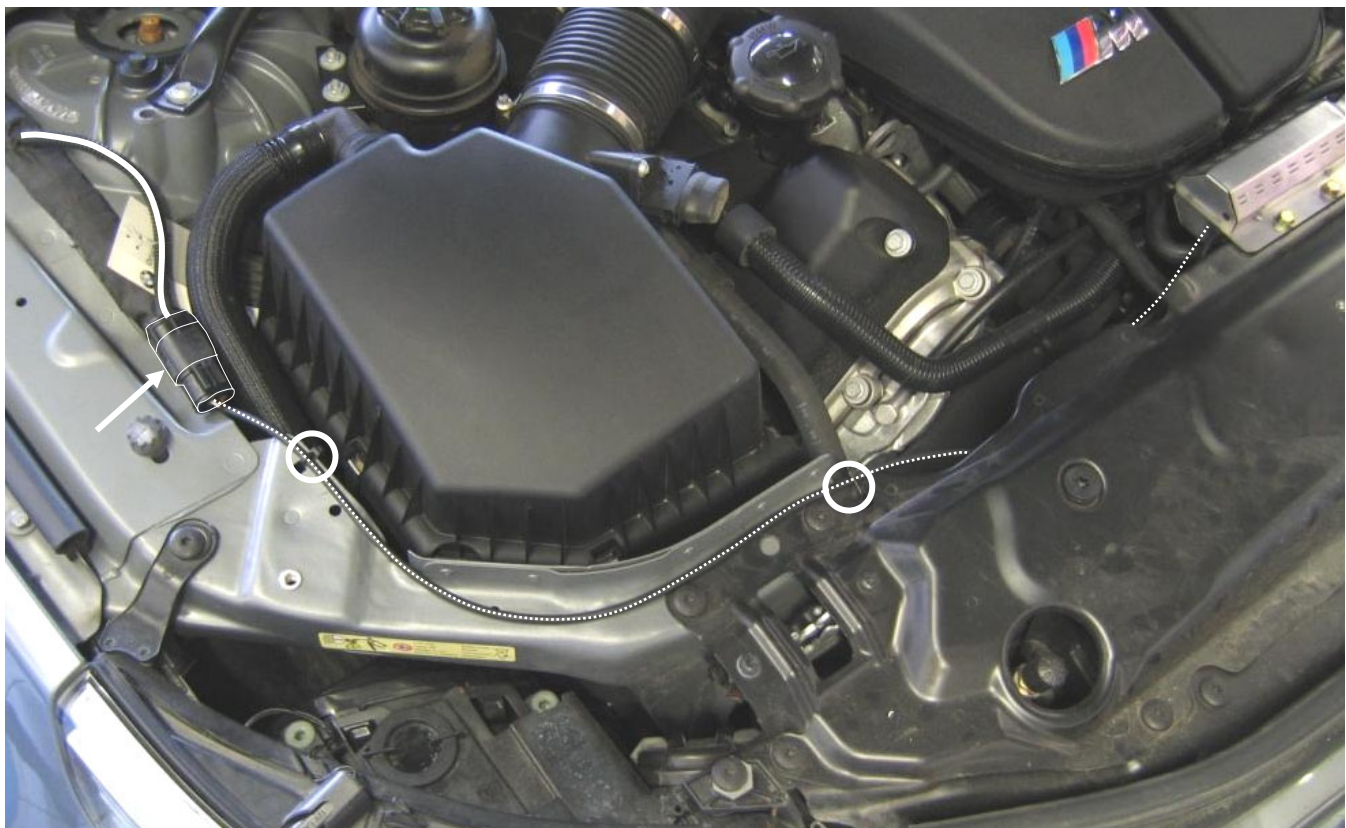

| | | | | |
|---|------------|--|----------------------|------------|
| Einbauhinweise / Installation Instructions | | | KW automotive | |
| Hinweis Nr./ Instruction No. | 685 10 117 | | Erstellt am/ Date | 29.07.2010 |

**Vorderachse/
Front axle:**

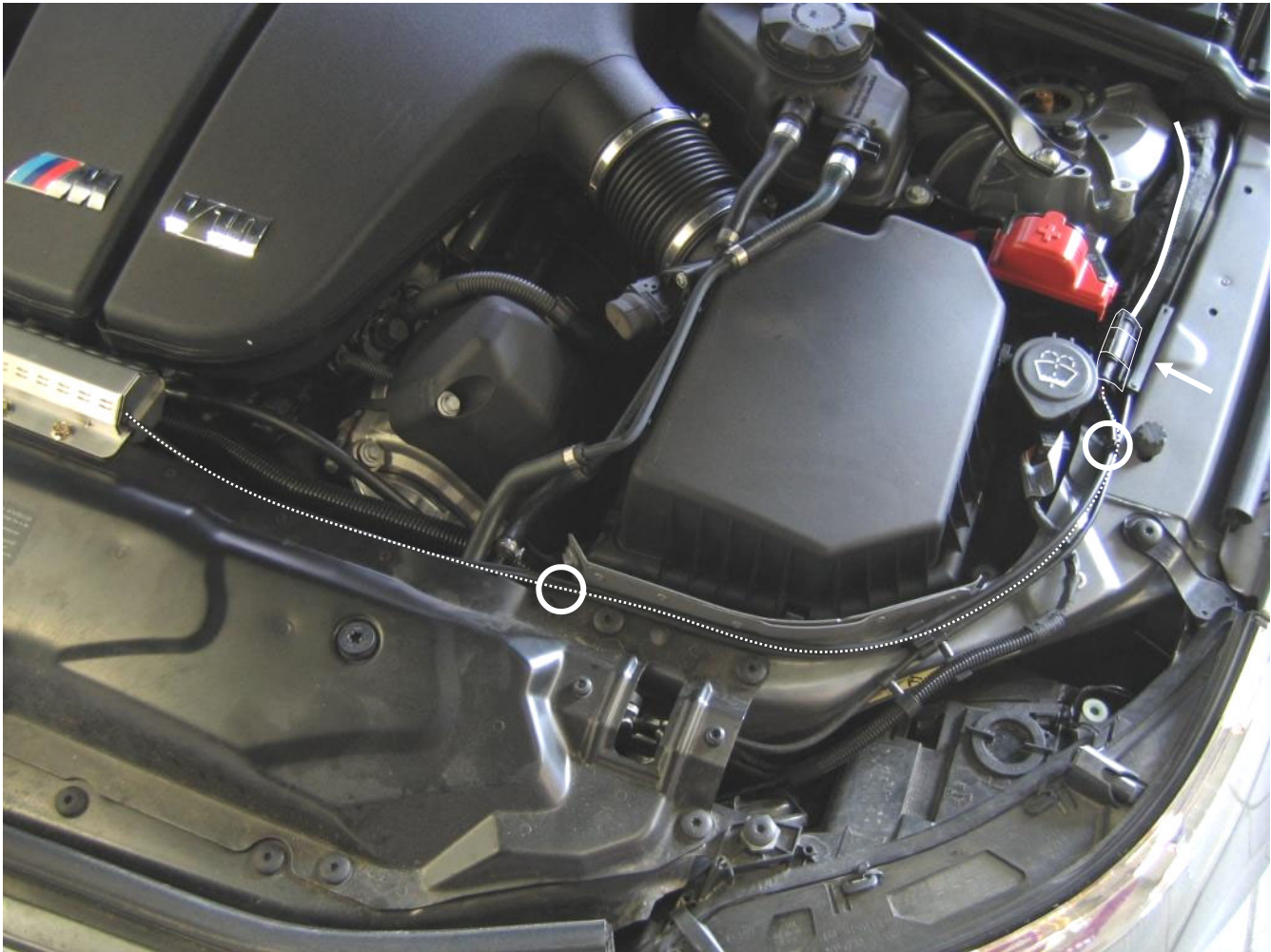

ACHTUNG: Steckverbinder gegen Quetschungen sichern.
IMPORTANT: Please secure the connectors against crushes.

| | | | | |
|---|------------|--|----------------------|------------|
| Einbauhinweise / Installation Instructions | | | KW automotive | |
| Hinweis Nr./ Instruction No. | 685 10 117 | | Erstellt am/ Date | 29.07.2010 |

**Hinterachse/
Rear axle:**

Kofferraum / Rear trunk

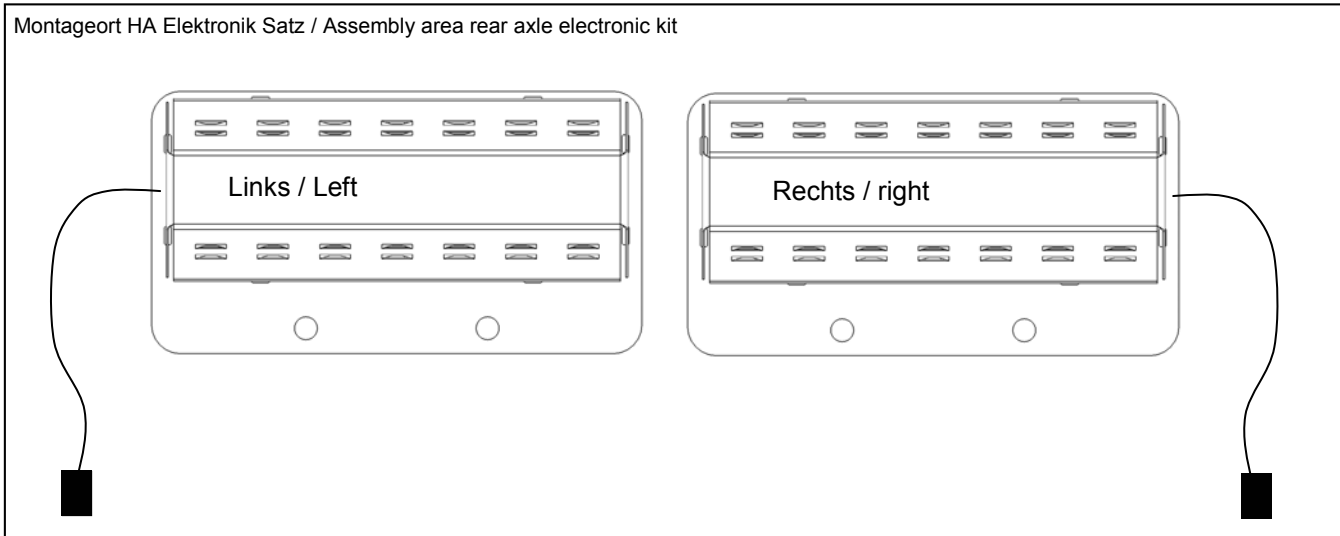

| | | | | |
|---|------------|--|----------------------|------------|
| Einbauhinweise / Installation Instructions | | | KW automotive | |
| Hinweis Nr./ Instruction No. | 685 10 117 | | Erstellt am/ Date | 29.07.2010 |

**Hinterachse/
Rear axle:**

HA Elektronik Satz ankleben und mit dem originalen Kabelbaum verbinden.
WICHTIG: Oberfläche muss Staub- und Fettfrei sein.
 Fix the rear axle electronic kit with the supplied tape and connect the cable with the original cable harness. **IMPORTANT: Surface must be cleaned and degreased.**

Links / Left



Rechts / Right

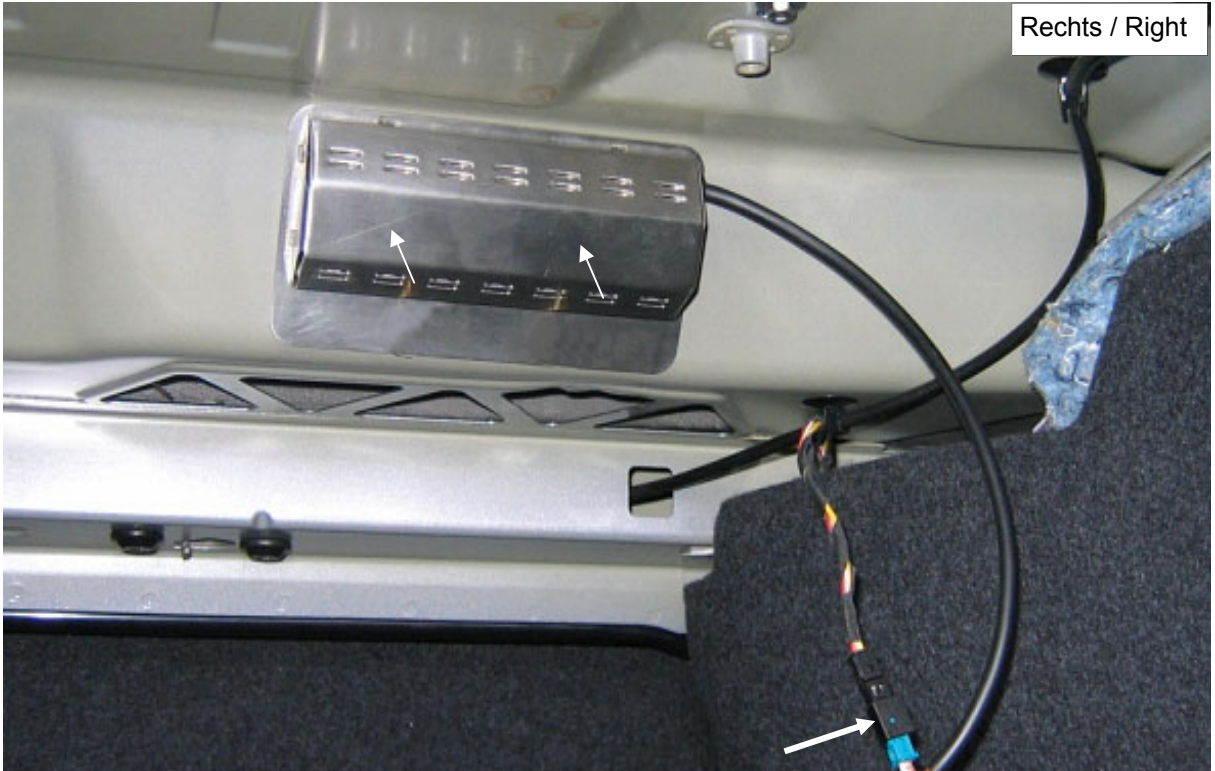

| | | | | |
|---|------------|--|----------------------|------------|
| Einbauhinweise / Installation Instructions | | | KW automotive | |
| Hinweis Nr./ Instruction No. | 685 10 117 | | Erstellt am/ Date | 29.07.2010 |

Hinterachse/ Rear axle:

Anschließen Kabel verlegen und an den markierten punkten mit Kabelbinder befestigen.

Lay the cable and fix it with the supplied cable ties on the marked points.

Links / Left



Rechts / Right

