



TYPHOON INTAKE SYSTEMS

INTAKE SYSTEMS FOR VEHICLES LISTED ARE 50 STATE LEGAL. SEE KNFILTERS.COM FOR CARB STATUS ON EACH PART FOR A SPECIFIC VEHICLE.

INSTALLATION INSTRUCTIONS

69-1207TP
69-1207TR
HONDA
2003-07 Accord
V6-3.0L

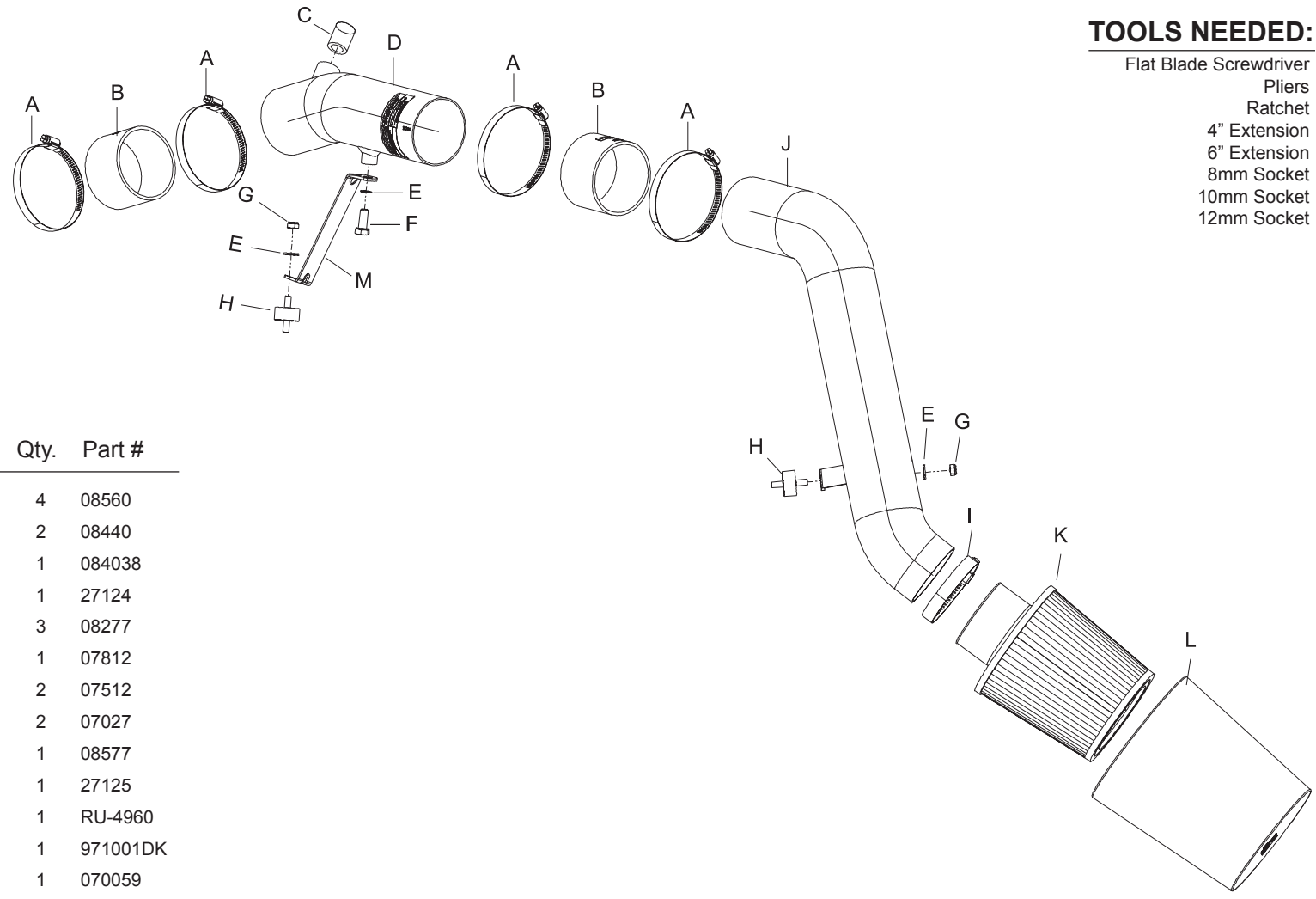

TOOLS NEEDED:

- Flat Blade Screwdriver
- Pliers
- Ratchet
- 4" Extension
- 6" Extension
- 8mm Socket
- 10mm Socket
- 12mm Socket

PARTS LIST:

| Description | Qty. | Part # |
|------------------------------|------|----------|
| A Hose Clamp #44 Stainless | 4 | 08560 |
| B Hose, Straight, Black | 2 | 08440 |
| C Hose, 1/2" I.D. x 1" L | 1 | 084038 |
| D Typhoon Short-Ram Tube | 1 | 27124 |
| E Washer, 6mm Wave | 3 | 08277 |
| F Bolt, 6mm x 16mm, SS | 1 | 07812 |
| G Nut, 6mm Nylock, SS | 2 | 07512 |
| H Vibration Mount | 2 | 07027 |
| I Hose Clamp #44 | 1 | 08577 |
| J Typhoon Cold Air Tube | 1 | 27125 |
| K Air Filter | 1 | RU-4960 |
| L Drycharger, Black | 1 | 971001DK |
| M Bracket; 69-1207, "Z", STL | 1 | 070059 |

WARNING: The K&N® Drycharger® included with this kit must be installed on the K&N® air filter when used with this K&N® cold air intake system. The K&N® cold air intake system a performance product that can be used safely during mild weather conditions. During harsh and inclement weather conditions, you must convert your cold air intake system to a short ram configuration, or return your vehicle to the stock OEM airbox and intake tract configuration. Failure to follow these instructions can void your warranty.

NOTE: FAILURE TO FOLLOW INSTALLATION INSTRUCTIONS AND NOT USING THE PROVIDED HARDWARE MAY DAMAGE THE INTAKE TUBE, THROTTLE BODY AND ENGINE.

TO START:

1. Turn off the ignition and disconnect the negative battery cable.
NOTE: Disconnecting the negative battery cable erases pre-programmed electronic memories. Write down all memory settings before disconnecting the negative battery cable. Some radios will require an anti-theft code to be entered after the battery is reconnected. The anti-theft code is typically supplied with your owner's manual. In the event your vehicles anti-theft code cannot be recovered, contact an authorized dealership to obtain your vehicles anti-theft code.

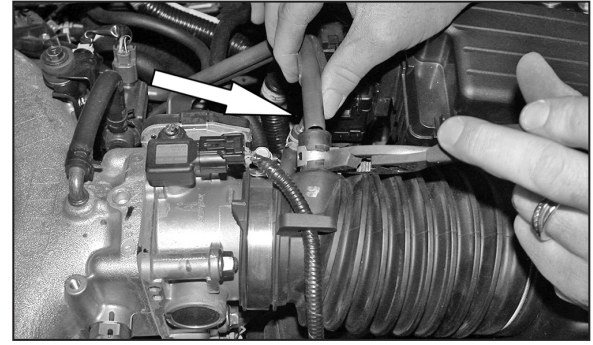

2. Depress the stock hose clamps, then, remove the crank case vent hard line from the stock intake tube as shown.

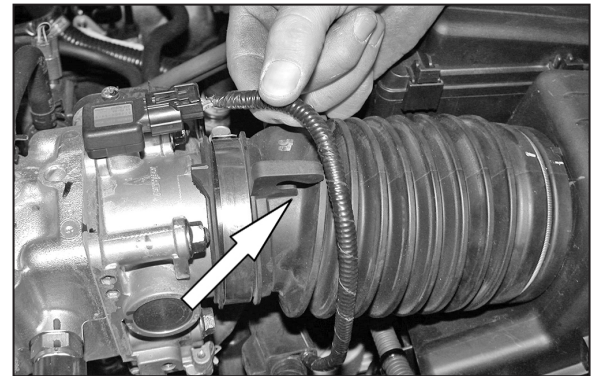

3. Unclip the wire harness from the stock intake tube as shown.



4. Loosen the hose clamp at the throttle body, then, remove the stock intake tube as shown.



5. Loosen the four bolts on the upper air cleaner assembly.

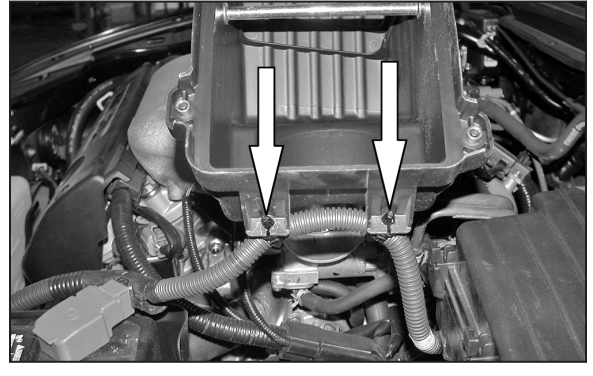

6. Rotate the upper air cleaner assembly up then using a pair of pliers unclip the wire harness and remove the upper air cleaner assembly as shown.

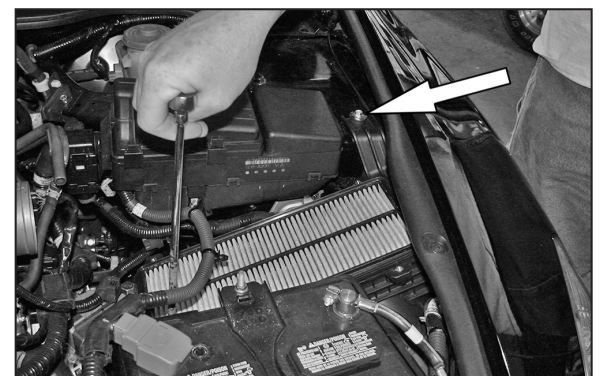

7. Loosen the two bolts on the lower air cleaner assembly as shown.

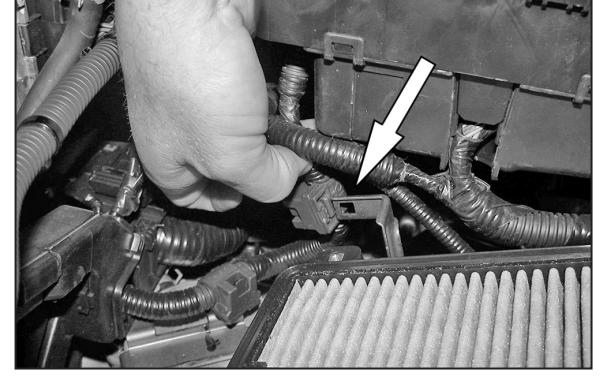

8. Using a pair of pliers unclip the wire harness from the bracket on the side of the lower air cleaner assembly as shown.

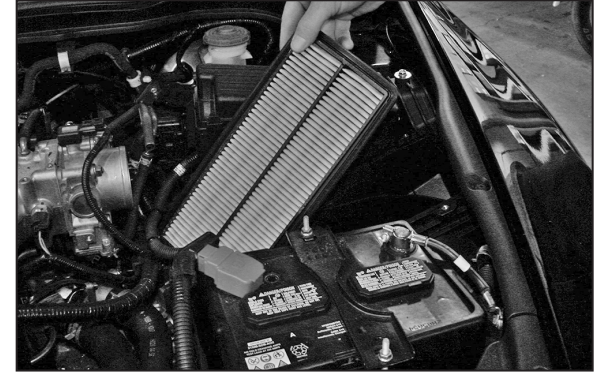

9. Remove the air cleaner as shown.



10. Pull up to release the lower air cleaner assembly from the stock air inlet duct and remove as shown.

NOTE: K&N Engineering, Inc., recommends that customers do not discard factory air intake.

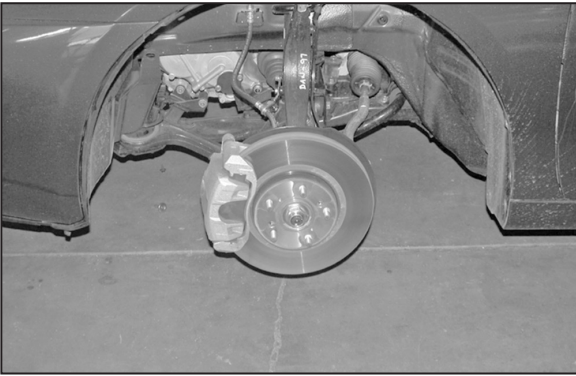

11. Raise the vehicle up and support it with jack stands, then, remove the driver side front tire as shown.

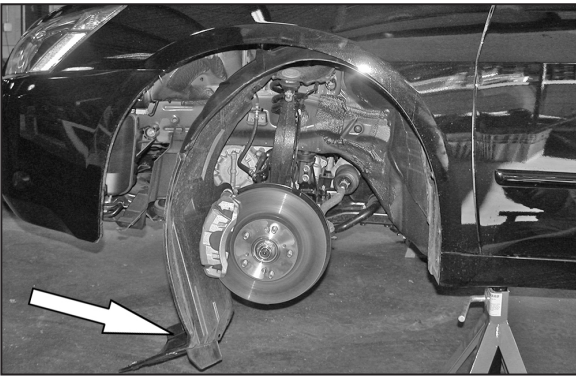

12. Remove the two bolts and six plastic rivets on the driver side inner fender valance, then, lower the valance down as shown.

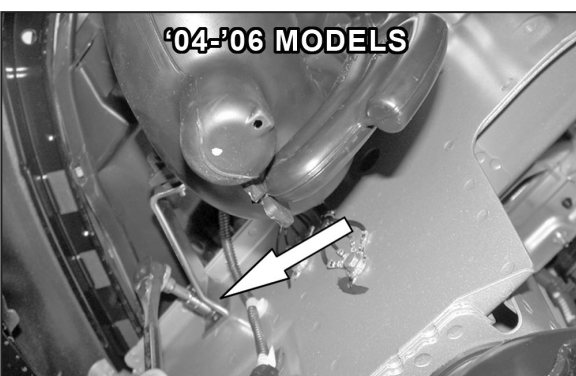
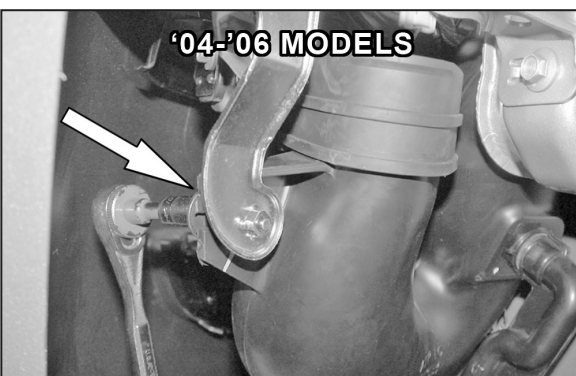
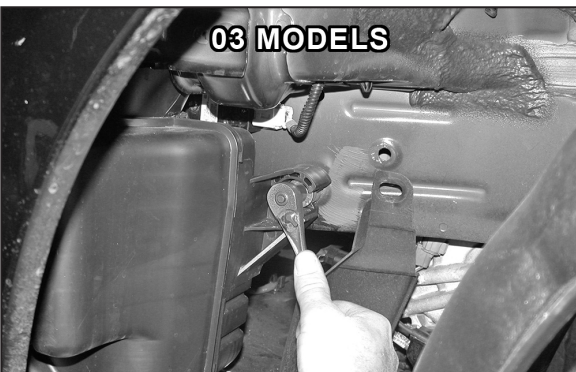

13. Remove the two bolts that secure the air intake resonator as shown. On '04-'06 models, refer to photos above as to locations of bolts.



14. Remove the air intake resonator as shown. **NOTE: Not all air intake resonators may look the same.**

NOTE: On '04-'06 models, skip steps 15 thru 24 and proceed to step 25.

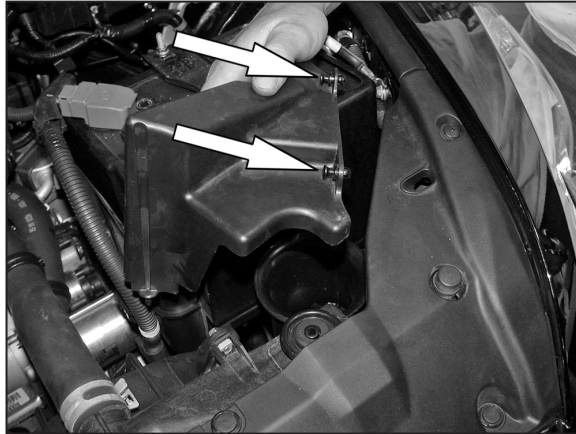

15. Located in front of battery, release the two plastic rivets, then, remove the plastic valance as shown.



16. Remove the air inlet duct as shown.



17. Loosen and remove the battery hold down bracket as shown.

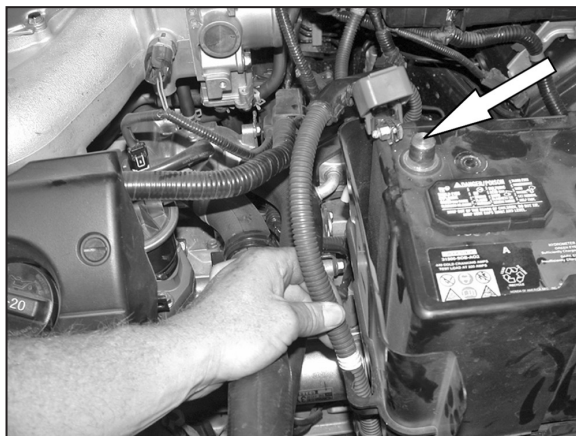

18. Disconnect the positive battery cable and unclip the cable from the side of the plastic battery cover.

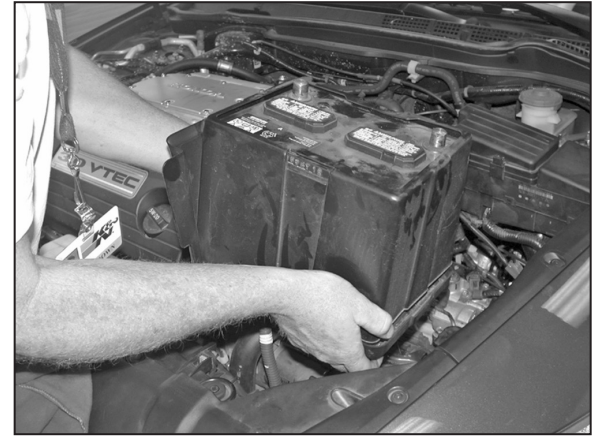

19. Remove the battery and the plastic cover as shown.

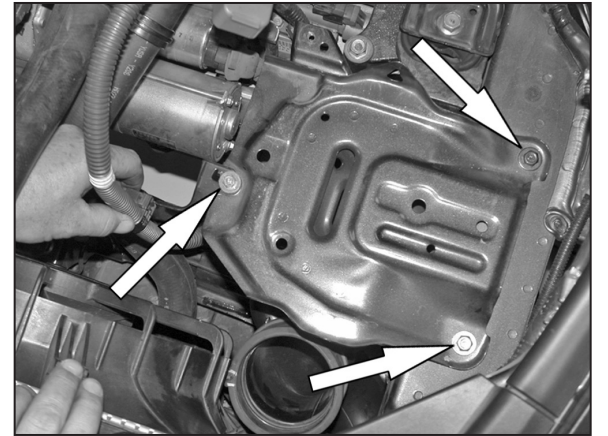

20. Unclip the battery cable from the battery tray, then, remove the two top bolts and loosen the two lower bolts that secure the battery tray to the inner fender.



21. Remove the battery tray as shown.



22. Loosen and remove the bolt that secures the air inlet duct to the inner fender as shown.



23. Remove the air inlet duct as shown.



24. Reverse the removal process and reinstall the battery tray, battery, plastic cover, battery hold down bracket, and the positive battery cable as shown.

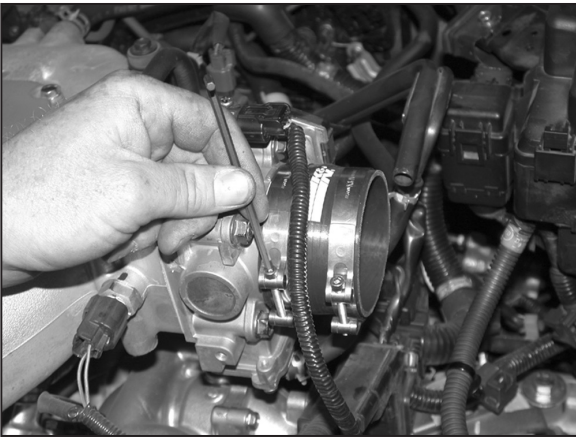

25. Install the silicone hose and hose clamps and tighten the hose clamp on the throttle body.

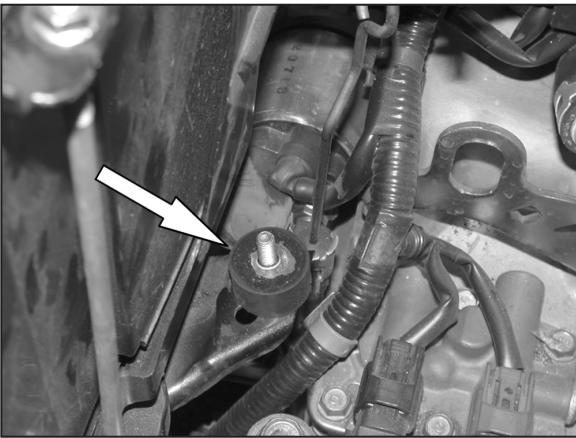

26. Install the rubber mounted stud into the original air cleaner mounting hole located directly behind the battery as shown.

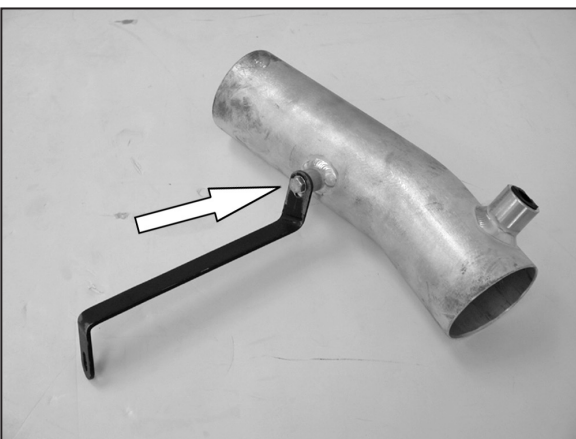

27. Secure the provided "Z" bracket to the K&N short ram tube using the provided hardware as shown.
NOTE: Before securing the "Z" bracket, inspect the inside of the tube for any debris, then clean the inside out with water and a towel. Inspect the tube one more time before proceeding to the next step.



28. Slide the provided silicone hose into the vent on the K&N short ram tube.

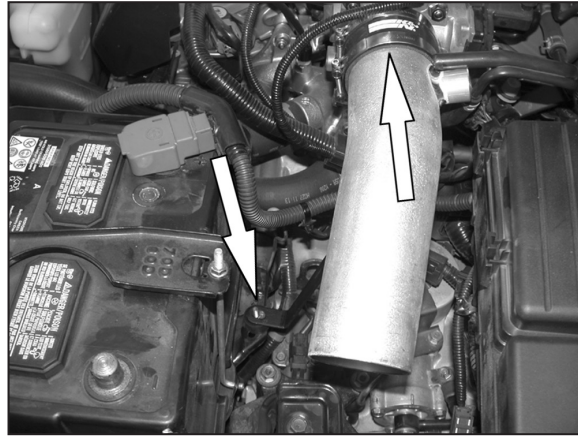

29. Slide the K&N short ram tube into the silicone hose on the throttle body, then, line up the "Z" bracket with the rubber mounted stud from step 26.

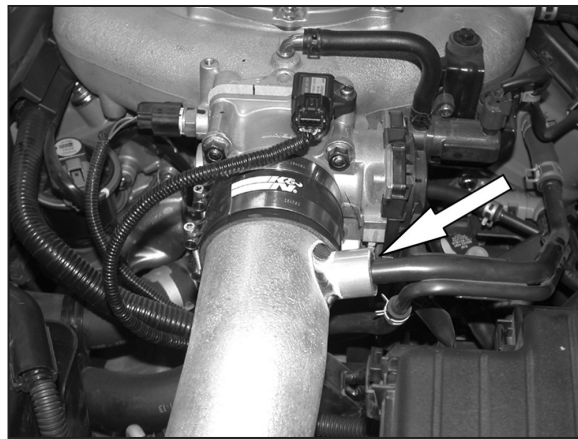

30. Slide the crankcase vent hard line into the vent on the K&N short ram tube as shown.

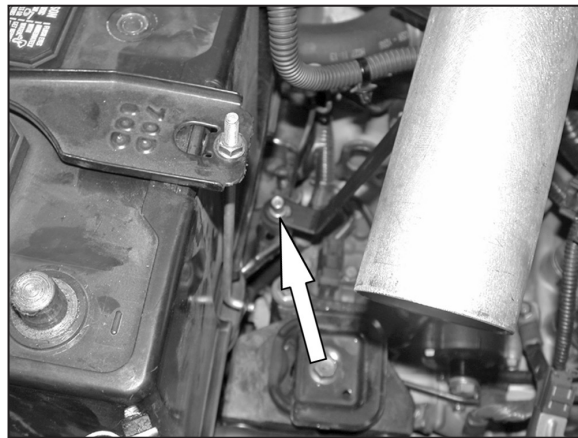

31. Secure the "Z" bracket to the rubber mounted stud using the provided hardware as shown, but do not tighten completely at this time.



32. Slide the silicone hose and hose clamps onto the K&N short ram tube as shown.
NOTE: Slide the silicone hose past the edge of the tube as this will help with the installation of the cold air tube.

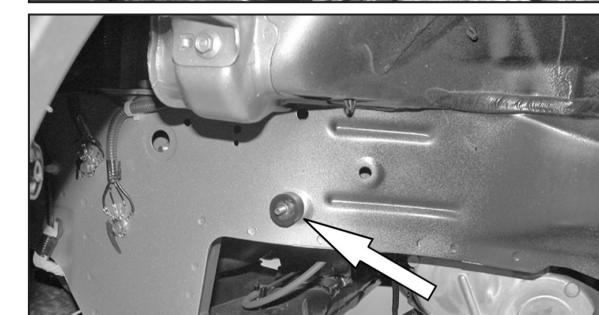
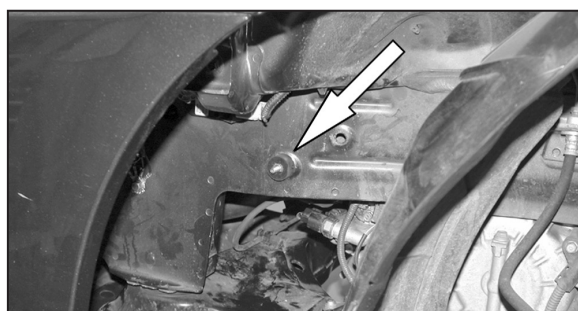

33. Install the rubber mounted stud into the original resonator mounting hole from step 13.
NOTE: On '04 models, install the rubber mounted stud into threaded hole as shown.



34. Slide the K&N cold air tube into the vehicle from underneath the vehicle as shown.
NOTE: Before installing the intake tube, inspect the inside of the tube for any debris, then clean the inside out with water and a towel. Inspect the tube one more time before proceeding to the next step.

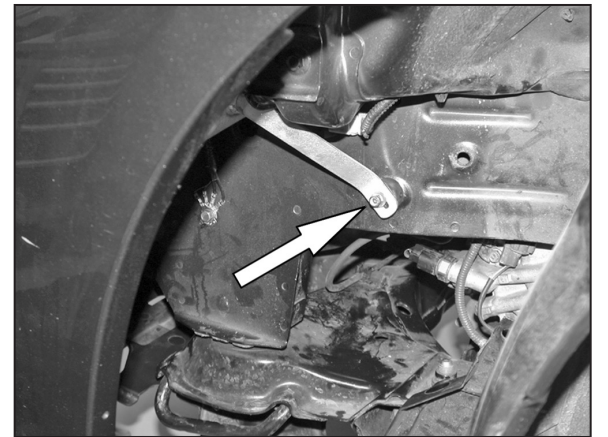

35. Secure the bracket on the cold air tube to the rubber mounted stud from step 33 using the provided hardware as shown.



36. Slide the silicone hose located on the short ram tube onto the cold air tube as shown.

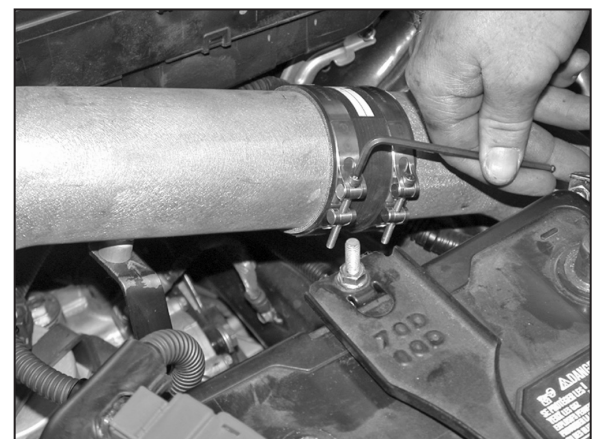

37. Align the tubes for best fit and clearance and tighten the hose clamps.



38. Tighten the hose clamp at the throttle body.

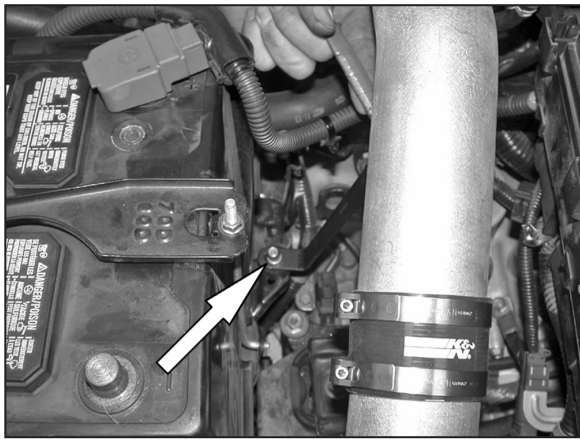

39. Tighten the hardware on the "Z" bracket at the tube and at the rubber mounted stud as shown.

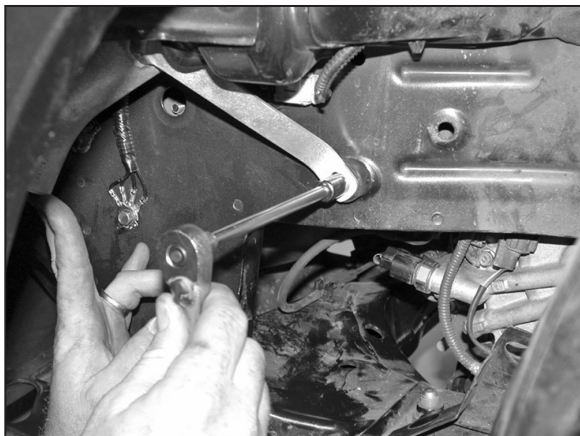

40. Tighten the hardware on the rubber mounted stud that secures the cold air tube as shown.

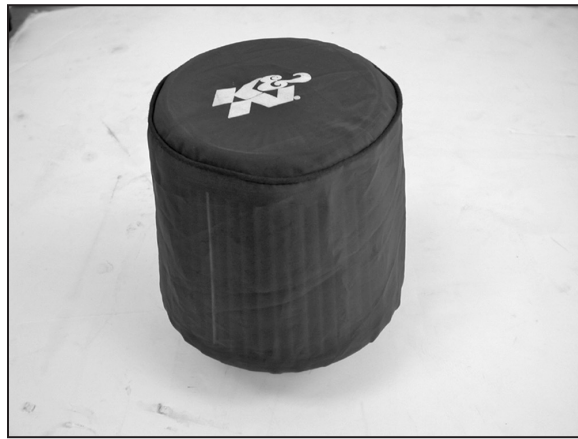

41. Slide the provided K&N® Drycharger® onto the K&N® air filter as shown.

NOTE: Please be aware the Drycharger® is water repellent, not water proof. Depending on conditions and usage the water repellent treatment is good for 1 to 2 years. See the parts list to reorder a new Drycharger® if necessary.



42. From underneath the vehicle install the K&N® air filter onto the cold air tube and secure with the provided hose clamp as shown.

43. Reverse the removal process and re-install the inner fender valance.

44. Re-install the driver side front tire and torque to factory specs.



45. This K&N® high flow intake system has been designed to be used in two different configurations. In the case of inclement weather, the cold air tube can be removed and the air filter can be clamped onto the intake tube located in the engine compartment to avoid the possibility of ingesting water into the engine.

NOTE: If you have any concerns, return the vehicle to stock using the factory equipment.

46. Reconnect the vehicle's negative battery cable. Double check to make sure everything is tight and properly positioned before starting the vehicle.

47. The C.A.R.B. exemption sticker, (attached), must be visible under the hood so that an emissions inspector can see it when the vehicle is required to be tested for emissions. California requires testing every two years, other states may vary.

48. It will be necessary for all K&N® high flow intake systems to be checked periodically for realignment, clearance and tightening of all connections. Failure to follow the above instructions or proper maintenance may void warranty.

ROAD TESTING:

1. Start the engine with the transmission in neutral or park, and the parking brake engaged. Listen for air leaks or odd noises. For air leaks secure hoses and connections. For odd noises, find cause and repair before proceeding. This kit will function identically to the factory system except for being louder and much more responsive.

2. Test drive the vehicle. Listen for odd noises or rattles and fix as necessary.

3. If road test is fine, you can now enjoy the added power and performance from your kit.

4. K&N Engineering, Inc., requires cleaning the intake system's air filter element every 100,000 miles. When used in dusty or off-road environments, our filters will require cleaning more often. We recommend that you visually inspect your filter once every 25,000 miles to determine if the screen is still visible. When the screen is no longer visible some place on the filter element, it is time to clean it. To clean and re-oil, purchase our filter Recharger® service kit, part number 99-5050 or 99-5000 and follow the easy instructions.

INTAKE SYSTEMS FOR VEHICLES LISTED ARE 50 STATE LEGAL. SEE KNFILTERS.COM FOR CARB STATUS ON EACH PART FOR A SPECIFIC VEHICLE.