



TYPHOON INTAKE SYSTEMS

INTAKE SYSTEMS FOR VEHICLES LISTED ARE 50 STATE LEGAL. SEE KNFILTERS.COM FOR CARB STATUS ON EACH PART FOR A SPECIFIC VEHICLE.

INSTALLATION INSTRUCTIONS

69-3530TS
FORD
2011-17 Fiesta
L4-1.6L

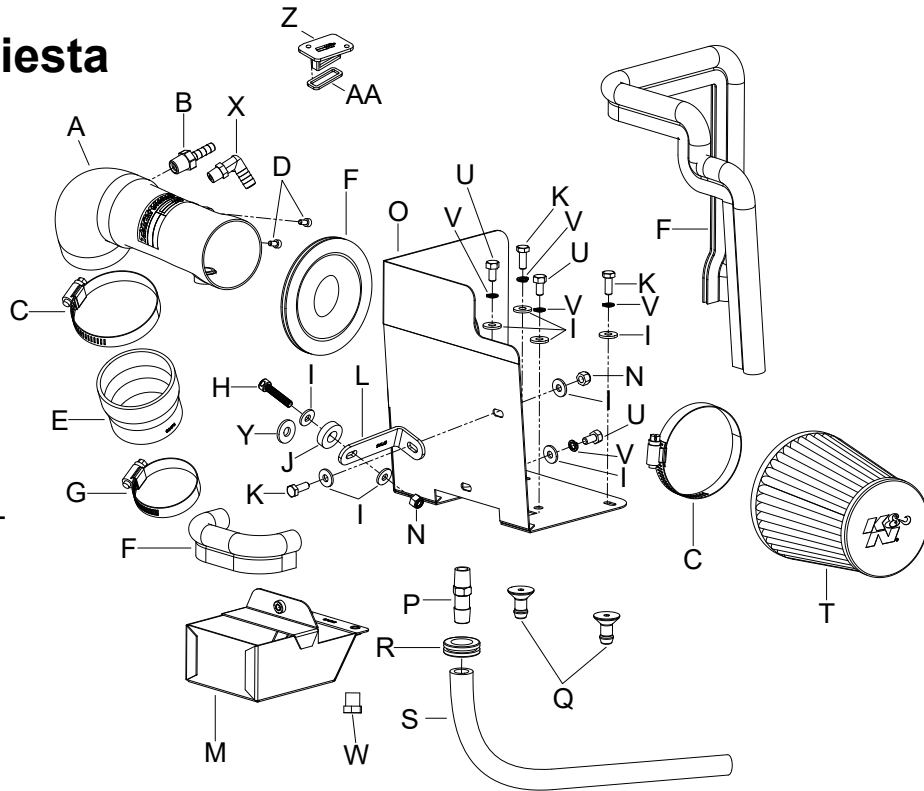

TOOLS NEEDED:

- 3mm Allen Wrench
- 5mm Allen Wrench
- 10mm Socket
- 10mm Wrench
- 9/16" Wrench
- Ratchet
- Extension
- Flat Blade Screwdriver
- Knife
- T27 Torx

PARTS LIST:

Description	Qty.	Part #
A INTAKE TUBE	1	27493TS
B VENT; STRT, 3/8" HOSE, 1/4" NPT, PLAS.	1	08047
C HOSE CLAMP # 40	2	08554
D BOLT; M4- 0.7 8MM, A/H CAP, SS	2	07733
E HOSE; 2-1/2" TO 2-1/4" ID X 2" L TPRD	1	08476
F EDGE TRIM (46")	1	102487
G HOSE CLAMP # 36	1	08530
H BOLT; SOCKET M6-1 X 30MM	1	1-2020
I WASHER, 1/4" ID X 5/8" OD -SAE	9	08275
J SPACER; 0.937" OD X .437"ID X .25"L, ZN	1	21715
K BOLT; 6MM -1.00 X 16MM, SS	3	07812
L BRACKET; SM "L" MILD STL, TB/PC	1	07195
M HEAT SHIELD SCOOP	1	074095
N NUT; 6MM NYLOCK, HEXHEAD, SS	2	07512
O HEAT SHIELD	1	074094
P VENT; STRT, 1/2" HOSE, 1/4" NPT, PLAS.	1	080022
Q NIPPLE, HEAT SHIELD MOUNT	2	8-186-1
R GROMMET; 3/4" ID	1	08058
S HOSE; 1/2" ID X 14"L	1	08402
T AIR FILTER	1	RC-9630
U BOLT; M6 X 1.00 X 12MM, HEXHEAD, SS	3	07727
V WASHER, M6 SPLIT LOCK ZINC	5	1-3025
W PLUG; 1/4 NPT, PLASTIC, BLACK	1	08032
X VENT; 1/2 X 1/2 PLASTIC ELBOW, BLK.	1	08065
Y WASHER; 1"D X 1/4 HOLE FENDER	1	08160
Z BLOCK OFF	1	09076
AA GASKET	1	21508

If you need any assistance please call 1-800-858-3333 to speak with a representative in our Customer Service Center before returning the product.

NOTE: FAILURE TO FOLLOW INSTALLATION INSTRUCTIONS AND NOT USING THE PROVIDED HARDWARE MAY DAMAGE THE INTAKE TUBE, THROTTLE BODY AND ENGINE.

TO START:

1. Turn off the ignition and disconnect the negative battery cable.
NOTE: Disconnecting the negative battery cable erases pre-programmed electronic memories. Write down all memory settings before disconnecting the negative battery cable. Some radios will require an anti-theft code to be entered after the battery is reconnected. The anti-theft code is typically supplied with your owner's manual. In the event your vehicles' anti-theft code cannot be recovered, contact an authorized dealership to obtain your vehicles anti-theft code.



2. Release the red locking tab and then disconnect the mass air sensor electrical connection.



3. When equipped with EVAP, disconnect the EVAP vent line from the factory intake tube as shown.



4. Loosen the two hose clamps that secure the factory intake tube and then remove the intake tube from the vehicle.



5. Release the locking collar for the crankcase vent hose to the airbox connection by pulling it back, so the crankcase vent hose can be disconnected from the airbox. Then disconnect the crankcase vent hose from the valve cover and remove it from the vehicle.



6. Disconnect the fresh air intake scoop from the core support.



7. Lift up the airbox assembly to dislodge it from the mounting grommets and then remove it from the vehicle.

NOTE: K&N Engineering, Inc., recommends that customers do not discard factory air intake.



8. Remove the airbox mounting bracket bolt shown.



9. Install the provided 30mm long Allen bolt and washer into the air box mounting bracket hole as shown. On some models it may be necessary to use the supplied larger washer.



10. Install the heat shield mounting bracket (07195) onto the bottom of the bolt installed in the previous step along with the spacer provided.
NOTE: The space will be between the bracket and core support.

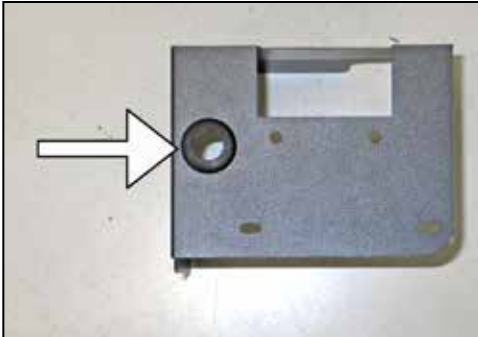

11. Install the provided grommet into the bottom of the heat shield as shown.

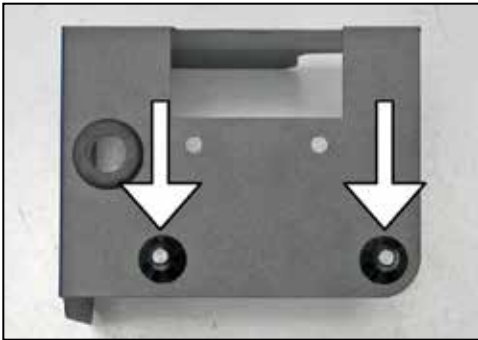

12. Install the two provided heat shield mounting studs to the bottom of the heat shield as shown using the provided hardware.

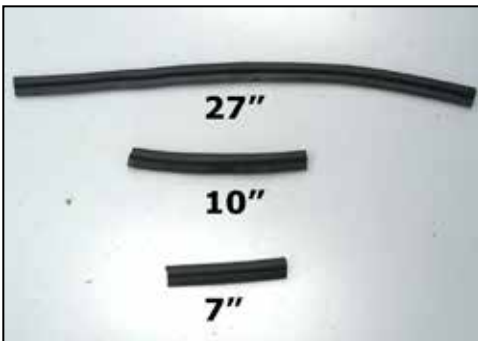

13. Cut the provided edge trim into three sections as shown, one 7" long, one 10" long and one 27" long.



14. Install the 10" section of edge trim into the hole of the heat shield as shown.

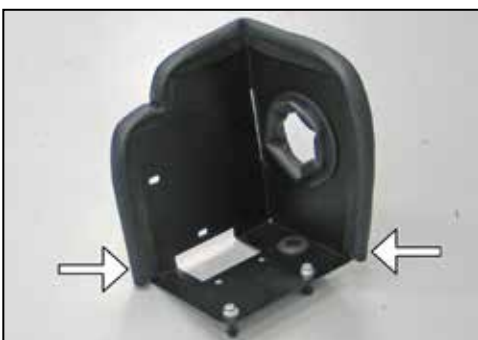

15. Install the 27" section of edge trim around the outside of the heat shield as shown.

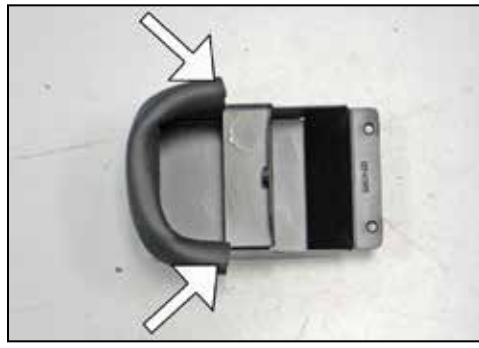

16. Install the 7" section of edge trim onto the fresh air intake scoop as shown.



17. Attach the fresh air scoop to the heat shield using the provided hardware.



18. Install the heat shield assembly onto the vehicle so that the mounting studs are inserted into the factory mounting grommets, and then secure to the mounting bracket installed during step #10 with the provided hardware.



19. Install the provided silicone hose (08476) onto the throttle body and secure with the provided hose clamp.

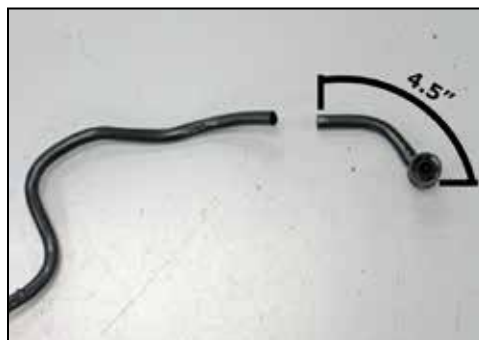

20. **US Models Only:** Measure back 4.5" from the end of the crankcase vent tube then cut the tube as shown.



21. **US Models Only:** Install the provided 1/2" silicone vent hose onto the cut vent tube as shown.



21a. Remove the rubber hose from the crankcase vent assembly and attach it to the valve cover as shown. Install the 1/4" 90° vent into the rubber hose as shown."



22. **US Models Only:** Reinstall the crankcase vent hose assembly onto the valve cover and route the silicone hose through the grommet in the bottom of the heat shield.



22a. **Non US models:** Install the provided 1/2" silicone vent hose onto the 1/4" vent and guide it along the fuel line towards the intake tube.



23. Disconnect the fresh air scoop from the airbox.



24. Install the fresh air scoop into the scoop attached to the heat shield and then reattach to the factory connection on the core support.



25. Remove the two bolts securing the mass air sensor to the factory airbox and then remove the mass air sensor from the airbox.
NOTE: Some vehicles may not be equipped with a mass air sensor.



26. On vehicles that are equipped with a mass air sensor install the sensor into the K&N® intake tube and secure with the provided hardware. On all other vehicles, install the provided gasket onto the block off plate and install the block off plate into the K&N® intake tube and secure with the provided hardware.

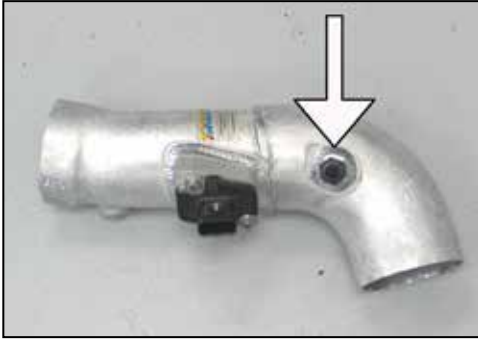

27. Install the provided 3/8" NPT vent fitting into the K&N® intake tube as shown.

NOTE: Plastic NPT fittings are easy to cross thread. Install the vent fitting "hand" tight, then turn it two complete turns with a wrench.



28. When equipped with EVAP, pass the K&N® intake tube through the heat shield and rotate so the remaining 1/2" npt vent fitting can be installed as shown.



28a. Models without EVAP: Pass the K&N® intake tube through the heat shield and rotate so the provided NPT plug (08032) can be installed into the K&N® intake tube as shown.



29. When equipped with EVAP, install the K&N® intake tube into the silicone hose at the throttle body and secure with the provided hose clamp. Attach the crankcase vent hose to the installed npt vent fitting.



30. When equipped with EVAP, install the EVAP vent hose to the npt vent fitting.

NOTE: Models without EVAP, attach the crankcase vent hose to the NPT vent fitting.



31. Reconnect the mass air sensor electrical connection.



32. Install the K&N® air filter and secure with the provided hose clamp.

NOTE: Drycharger® air filter wrap; part # RC-9350DK is available to purchase separately. To learn more about Drycharger® filter wraps or look up color availability please visit <http://www.knfilters.com>®.



33. Reconnect the vehicle's negative battery cable. Double check to make sure everything is tight and properly positioned before starting the vehicle.

34. The C.A.R.B. exemption sticker, (attached), must be visible under the hood so that an emissions inspector can see it when the vehicle is required to be tested for emissions. California requires testing every two years, other states may vary.

35. It will be necessary for all K&N® high flow intake systems to be checked periodically for realignment, clearance and tightening of all connections. Failure to follow the above instructions or proper maintenance may void warranty.

ROAD TESTING:

1. Start the engine with the transmission in neutral or park, and the parking brake engaged. Listen for air leaks or odd noises. For air leaks secure hoses and connections. For odd noises, find cause and repair before proceeding. This kit will function identically to the factory system except for being louder and much more responsive.

2. Test drive the vehicle. Listen for odd noises or rattles and fix as necessary.

3. If road test is fine, you can now enjoy the added power and performance from your kit.

4. K&N Engineering, Inc., requires cleaning the intake system's air filter element every 100,000 miles. When used in dusty or off-road environments, our filters will require cleaning more often. We recommend that you visually inspect your filter once every 25,000 miles to determine if the screen is still visible. When the screen is no longer visible some place on the filter element, it is time to clean it. To clean and re-oil, purchase our filter Recharger® service kit, part number 99-5050 or 99-5000 and follow the easy instructions.

INTAKE SYSTEMS FOR VEHICLES LISTED ARE 50 STATE LEGAL. SEE KNFILTERS.COM FOR CARB STATUS ON EACH PART FOR A SPECIFIC VEHICLE.