



TYPHOON INTAKE SYSTEMS

INTAKE SYSTEMS FOR VEHICLES LISTED ARE 50 STATE LEGAL. SEE KNFILTERS.COM FOR CARB STATUS ON EACH PART FOR A SPECIFIC VEHICLE.

INSTALLATION INSTRUCTIONS

69-4516TS CHEVROLET 2005-06 Cobalt SS L4-2.0L Supercharged

TOOLS NEEDED:

- Flat Blade Screwdriver
- Phillips Blade Screwdriver
- Pliers
- Ratchet
- Extension
- 10mm Socket
- 9/32 Socket
- 5/16 Socket
- 3mm Allen Key

PARTS LIST:

Description	Qty.	Part #	Description	Qty.	Part #
A Hose Clamp; #44	2	08560	G Washer; 6mm Wave, SS	1	08277
B Hose; 2-3/4" To 3" X 2", Sil, Blk.	1	084036	H Bracket; "Z", Stl, FB/PC	1	010033
C Intake Tube	1	27507	I Stud; Rubber Mnt., 1/2"L X 1"W	1	070228
D Edge Trim; 1/16"Gap, 32"L	1	102456	J Hose Clamp #48	1	08601
E Bolt; M4-0.07 8mm, A/h Cap, SS	2	07733	K Air Filter	1	RU-4990
F Bolt; 6mm-1.00 X 12mm Hex	1	07863	L Drycharger Wrap, Black	1	RX-4990D

WARNING: The K&N® Drycharger® included with this kit must be installed on the K&N® air filter when used with this K&N® cold air intake system. The K&N® cold air intake system a performance product that can be used safely during mild weather conditions. During harsh and inclement weather conditions, you must convert your cold air intake system to a short ram configuration, or return your vehicle to the stock OEM airbox and intake tract configuration. Failure to follow these instructions can void your warranty.

NOTE: FAILURE TO FOLLOW INSTALLATION INSTRUCTIONS AND NOT USING THE PROVIDED HARDWARE MAY DAMAGE THE INTAKE TUBE, THROTTLE BODY AND ENGINE.

TO START:

1. Turn off the ignition and disconnect the negative battery cable.

NOTE: Disconnecting the negative battery cable erases pre-programmed electronic memories. Write down all memory settings before disconnecting the negative battery cable. Some radios will require an anti-theft code to be entered after the battery is reconnected. The anti-theft code is typically supplied with your owner's manual. In the event your vehicles' anti-theft code cannot be recovered, contact an authorized dealership to obtain your vehicles anti-theft code.

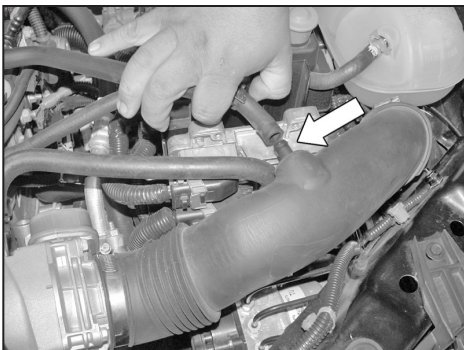

2. Remove the crankcase vent hose from stock intake tube as shown.



3. Loosen the two intake tube hose clamps and remove intake tube from vehicle as shown.

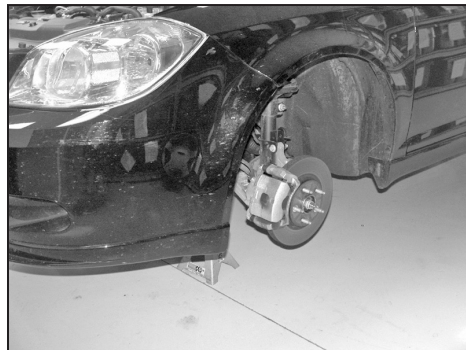

4. Jack the vehicle up and support with jack stand, then remove tire as shown.

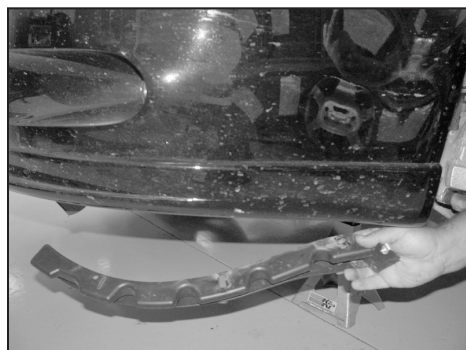

5. From underneath the vehicle, remove the push pins that secure the front lip support.



6. Remove the push clips that secure the inner fender well valance. On some models, push clips were replaced by screws.



7. Pull the valance over the brake rotor to make some working room.

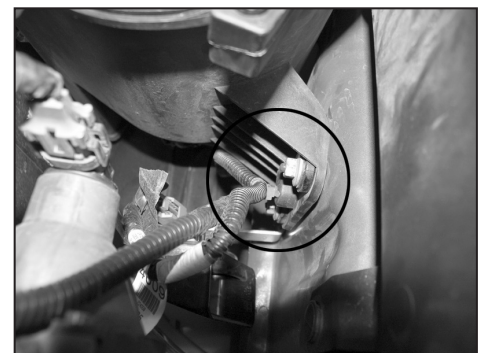

8. From underneath the vehicle, remove the electrical harness support clip.

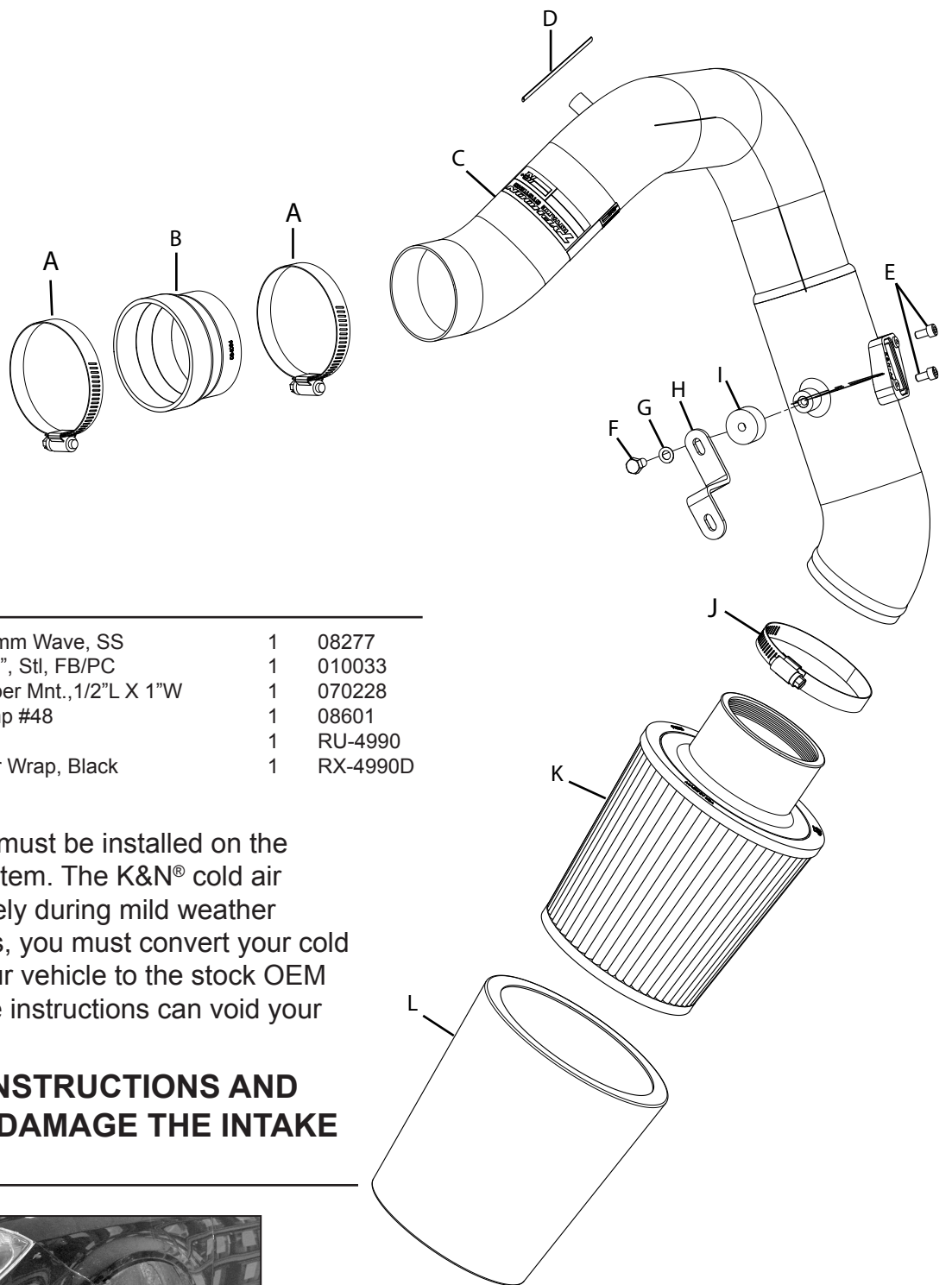

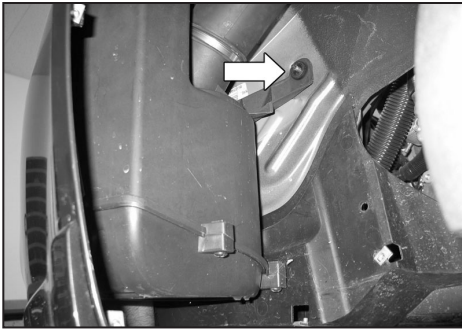
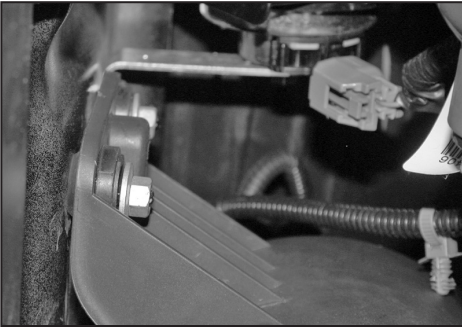

9. Remove the three bolts that secure the lower air box.

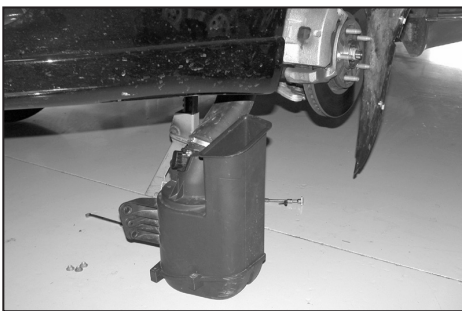

10. Disconnect the mass air sensor electrical connection from lower air box then remove the lower air box from vehicle.

NOTE: K&N Engineering, Inc., recommends that customers do not discard factory air intake.



11. Remove the mass air sensor from stock intake tube as shown.

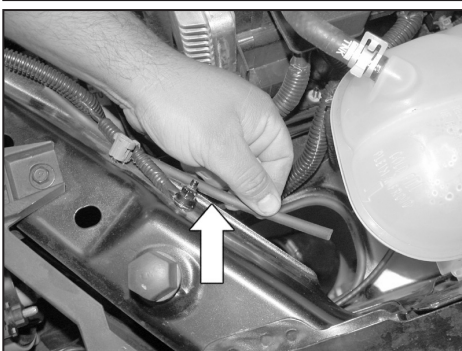
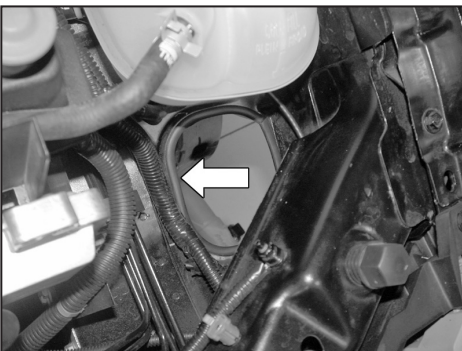

12. Measure, cut and install the provided edge trim to the hole in the fender well (top photo), then install the remaining piece to the edge of the radiator core support as shown.

NOTE: Some trimming of the edge trim will be necessary.

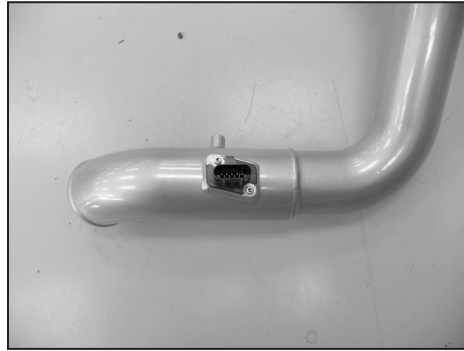

13. Install the mass air sensor onto the K&N® intake tube and secure with the provided hardware.

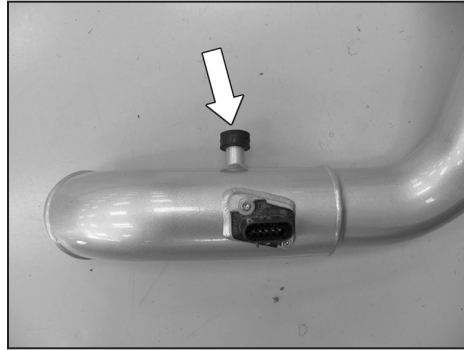

14. Install the provided rubber mounted stud onto the K&N® intake tube as shown.

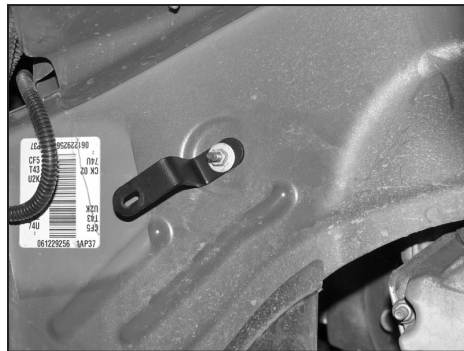

15. Install the provided "Z" bracket (010033) onto the factory air box mounting stud and secure with the factory nut as shown.

NOTE: The short end of the bracket should be attached to the fender well.

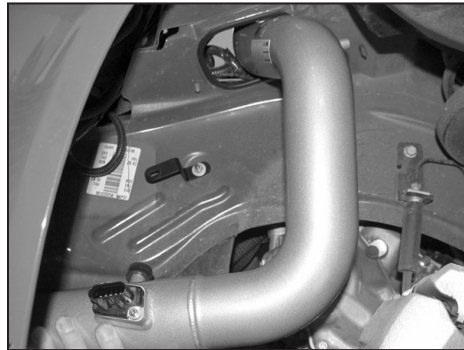

16. From underneath the vehicle, slide the K&N® intake tube up and through the hole in the fender well.



17. Install the silicone hose and provided hose clamps onto the K&N® intake tube as shown.

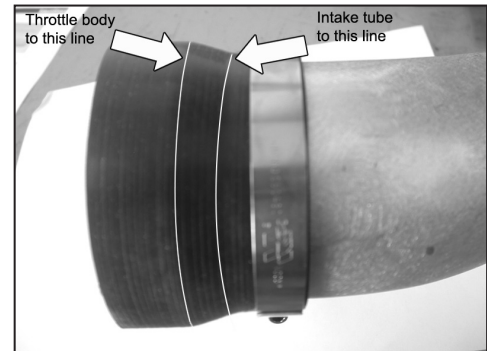
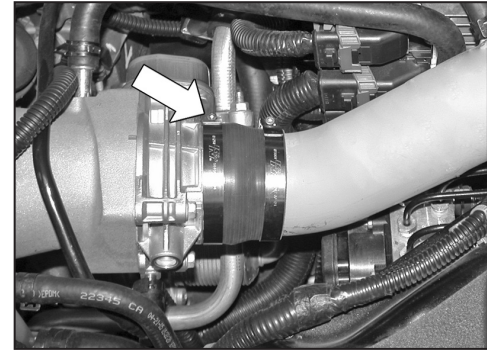

18. Slide the silicone hose and hose clamp over the throttle body then position the intake tube to where it does not go beyond the transition point of the silicone hose.

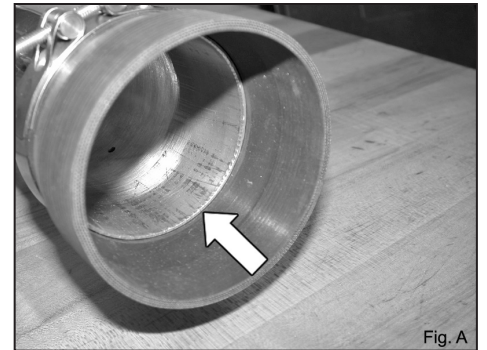

Fig. A

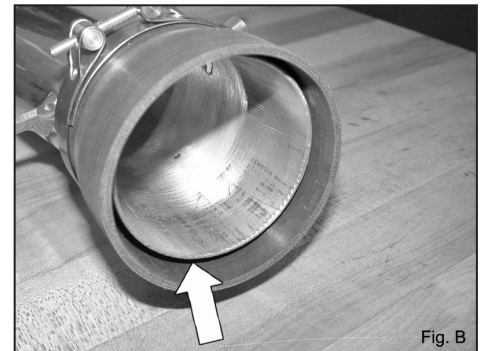
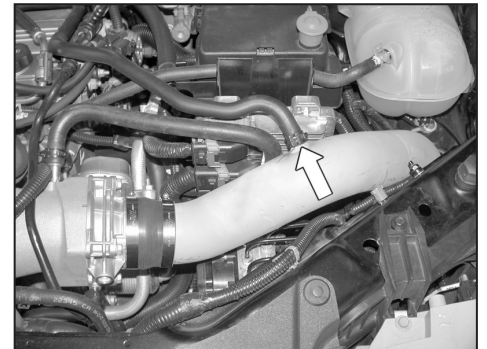

Fig. B

19. Please note that fig. A above denotes the correct way to install the silicone hose which has no open seal on the contact by the hose and tube. On Fig. B, this is an incorrect install of the silicone hose noting that there is an open area between the silicone hose and the intake tube.



20. From underneath the vehicle, secure the K&N® intake tube to the mounting bracket installed in step #15.



21. Reconnect the crankcase vent hose onto the K&N® intake tube.

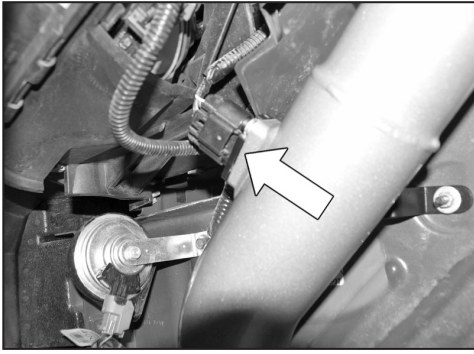

22. Reconnect the mass air sensor onto the K&N® intake tube as shown.



23. Install the K&N® Drycharger® on the the K&N® air filter.

NOTE: Please be aware the Drycharger® is water repellent, not water proof. Depending on conditions and usage the water repellent treatment is good for 1 to 2 years. See the parts list to reorder a new Drycharger® if necessary.



24. Install the K&N® air filter onto the intake tube and secure it with the provided hose clamp as shown.



25. Reconnect the vehicle's negative battery cable. Double check to make sure everything is tight and properly positioned before starting the vehicle. **WARNING: Please follow these installation instructions carefully. The K&N® high flow intake system is a performance product that can be used safely during mild weather conditions. During harsh and inclement weather conditions, you must return your vehicle to stock OEM air box and intake tract configuration. Failure to follow these instructions will void your warranty.**

26. The C.A.R.B. exemption sticker, (attached), must be visible under the hood so that an emissions inspector can see it when the vehicle is required to be tested for emissions. California requires testing every two years, other states may vary.

27. It will be necessary for all K&N® high flow intake systems to be checked periodically for realignment, clearance and tightening of all connections. Failure to follow the above instructions or proper maintenance may void warranty.

ROAD TESTING:

1. Start the engine with the transmission in neutral or park, and the parking brake engaged. Listen for air leaks or odd noises. For air leaks secure hoses and connections. For odd noises, find cause and repair before proceeding. This kit will function identically to the factory system except for being louder and much more responsive.
2. Test drive the vehicle. Listen for odd noises or rattles and fix as necessary.
3. If road test is fine, you can now enjoy the added power and performance from your kit.
4. K&N Engineering, Inc., requires cleaning the intake system's air filter element every 100,000 miles. When used in dusty or off-road environments, our filters will require cleaning more often. We recommend that you visually inspect your filter once every 25,000 miles to determine if the screen is still visible. When the screen is no longer visible some place on the filter element, it is time to clean it. To clean and re-oil, purchase our filter Recharger® service kit, part number 99-5050 or 99-5000 and follow the easy instructions.

INTAKE SYSTEMS FOR VEHICLES LISTED ARE 50 STATE LEGAL. SEE KNFILTERS.COM FOR CARB STATUS ON EACH PART FOR A SPECIFIC VEHICLE.

* FREE K&N® decal To register your warranty, please see us online at knfilters.com/register. FREE K&N® decal *