



TYPHOON INTAKE SYSTEMS

INTAKE SYSTEMS FOR VEHICLES LISTED ARE 50 STATE LEGAL. SEE KNFILTERS.COM FOR CARB STATUS ON EACH PART FOR A SPECIFIC VEHICLE.

INSTALLATION INSTRUCTIONS

69-7003TTK
NISSAN
2013-14 Sentra
L4-1.8L

TOOLS NEEDED:

- ratchet extension
- 10mm socket
- flat blade screw driver
- phillips screw driver
- 3mm allen key
- 10mm wrench
- pliers

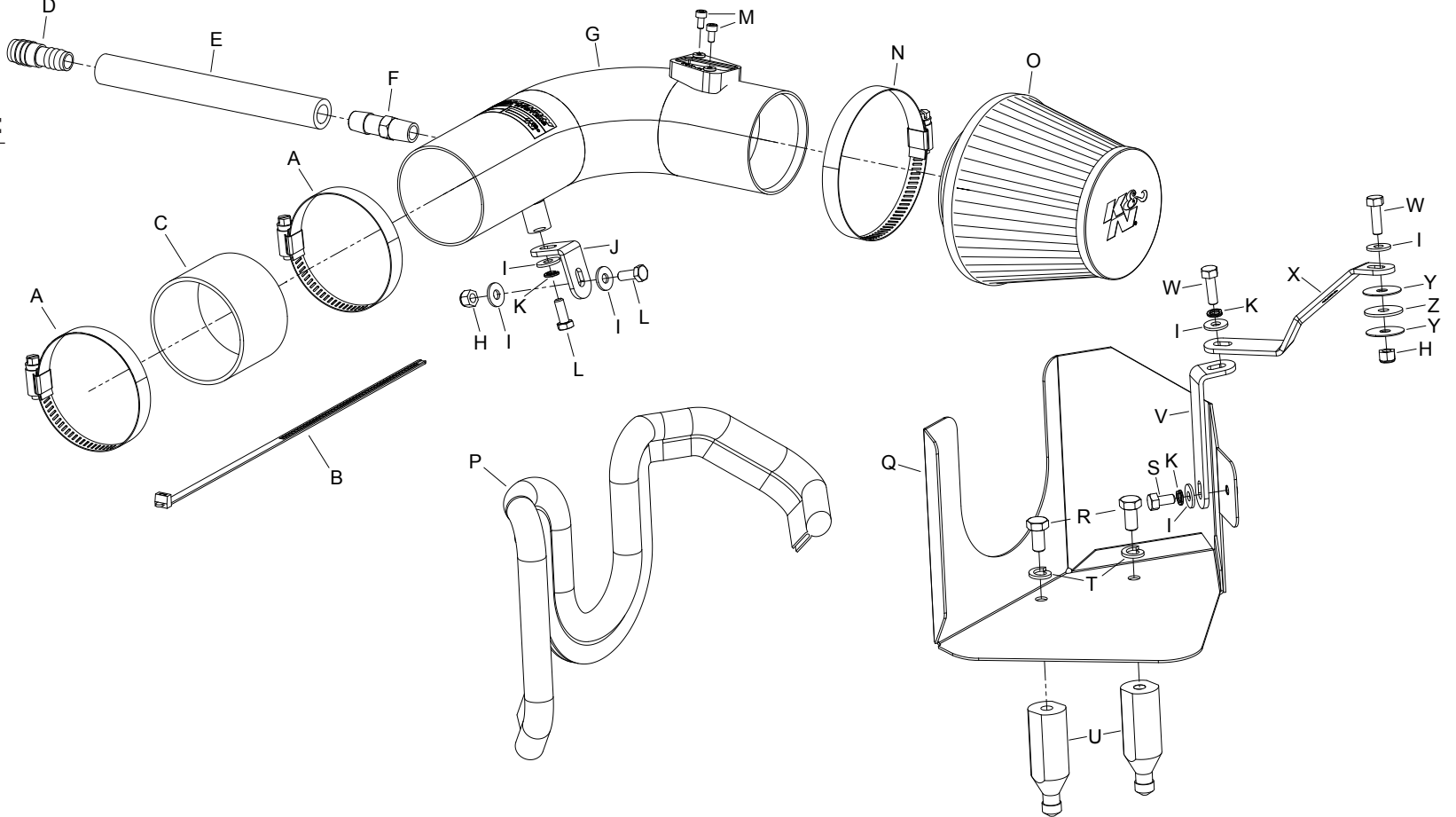

PARTS LIST:

Description	Qty.	Part #	Description	Qty.	Part #	Description	Qty.	Part #
A Hose Clamp #44 Stainless	2	08560	J Bracket; "L", 69-7003, STL	1	010040	S Bolt; M6 X 1.00 X 12MM	1	07727
B Cable Ties; 11" Black	1	21590	K Washer; M6 Split Lock, Zinc	3	1-3025	T Washer; M8 Split Lock Zinc	2	1-3036
C Hose; 2-3/4"ID X 2"L Reinforced	1	08440	L Bolt; 6MM-1.00 X 16MM,SS	2	07812	U Standoff	2	06532
D Hose Mender; 1/2" To 5/8"	1	08726	M Bolt; M4-0.07 8MM, A/H, Cap,SS	2	07733	V Bracket; 69-8605, "L" Short, STL	1	064314
E Hose; 1/2"ID X 7"L	1	08159	N Clamp; #48, DIA 65/89MM, STD	1	08601	W Bolt; M6 X 1.00" X 20MM Hex	2	07795
F Vent; STRT 1/2" Hose, 1/4"	1	080022	O Air Filter	1	RC-5128	X Bracket; "Z", 69-7003, STL	1	064315
G Intake Tube	1	27607TK	P Edge Trim (30")	1	102489	Y Washer; 1"D X 1/4 Hole Mender	2	08160
H Nut; 6MM Nylock, Hexhead, SS	2	07512	Q Heat Shield	1	073153	Z Washer; 1" X .300 X 1.00 Rubber	1	21685
I Washer; 6MM Flat, SS	6	08269	R Bolt; 8MM-1.25 X 16MM,	2	07844			

NOTE: FAILURE TO FOLLOW INSTALLATION INSTRUCTIONS AND NOT USING THE PROVIDED HARDWARE MAY DAMAGE THE INTAKE TUBE, THROTTLE BODY AND ENGINE.

TO START:

1. Turn off the ignition and disconnect the negative battery cable.
NOTE: Disconnecting the negative battery cable erases pre-programmed electronic memories. Write down all memory settings before disconnecting the negative battery cable. Some radios will require an anti-theft code to be entered after the battery is reconnected. The anti-theft code is typically supplied with your owner's manual. In the event your vehicles anti-theft code cannot be recovered, contact an authorized dealership to obtain your vehicles anti-theft code.



2. Lift up and remove the engine cover.

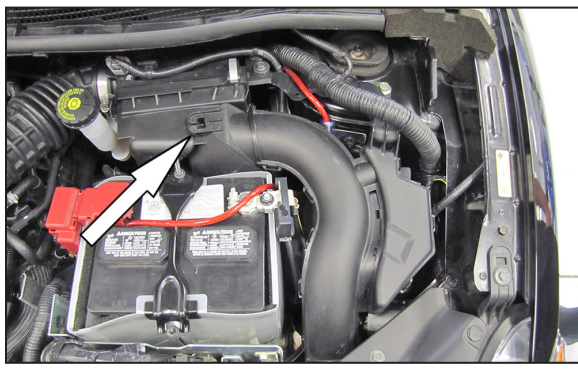

3. Unclip the fresh air intake from the air box and then pull the duct up to unhook it from retaining grommet and remove it from the vehicle.

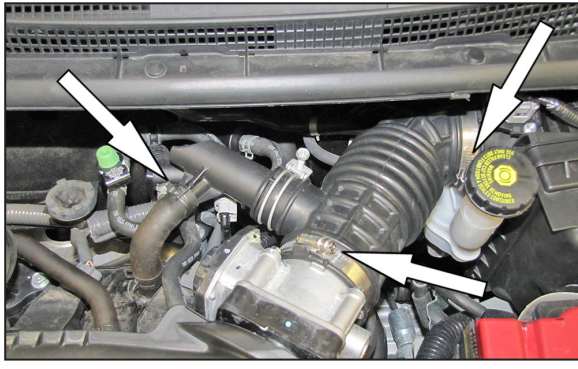

4. Release the spring clamp securing the crank case vent hose to the intake hose and disconnect the hose from the intake tube. Loosen the hose clamps securing the intake hose to the air box and throttle body.



5. Remove the intake hose from the vehicle.



6. Release the two air box clips and then remove the front half of the air box and air filter.

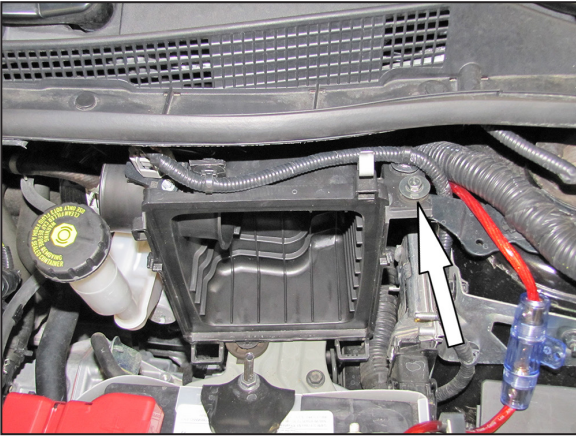

7. Remove the bolt which secures the rear air box half.

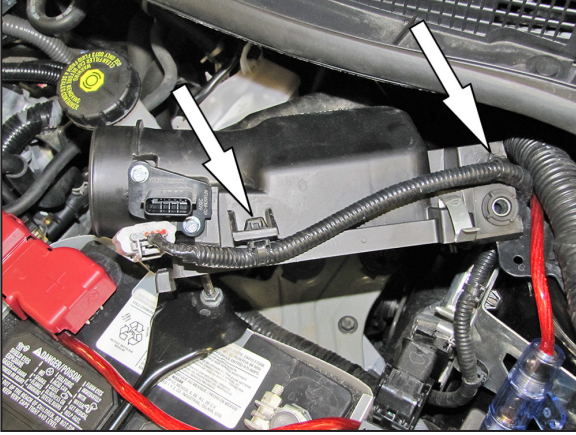

8. Pull the rear air box up and forward, then unhook the mass air sensor electrical connection and unhook the wiring harness from the air box. Then remove the rear air box from the vehicle.
NOTE: K&N Engineering, Inc., recommends that customers do not discard factory air intake.

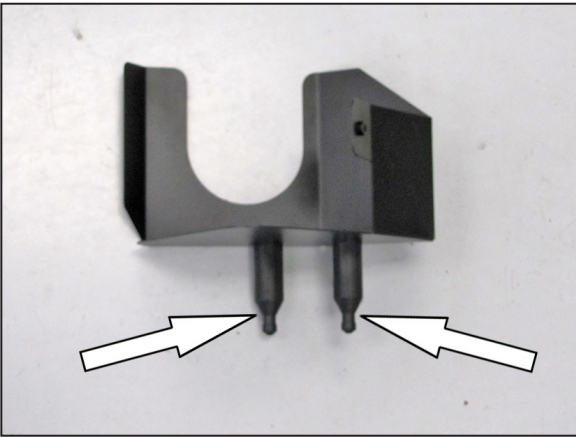

9. Install the two stand-offs to the K&N® heat shield as shown.

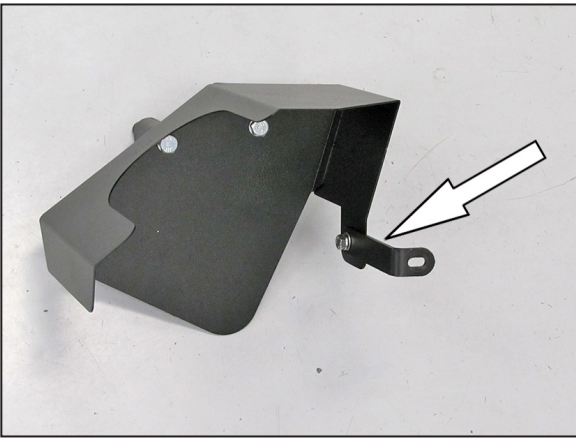

10. Install the provided heat shield bracket (010040) onto the heat shield as shown.

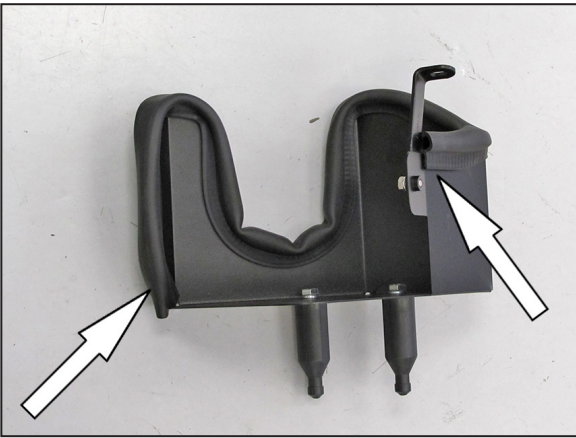

11. Install the provided edge trim onto the heat shield as shown.
NOTE: Some trimming of the edge trim will be necessary.

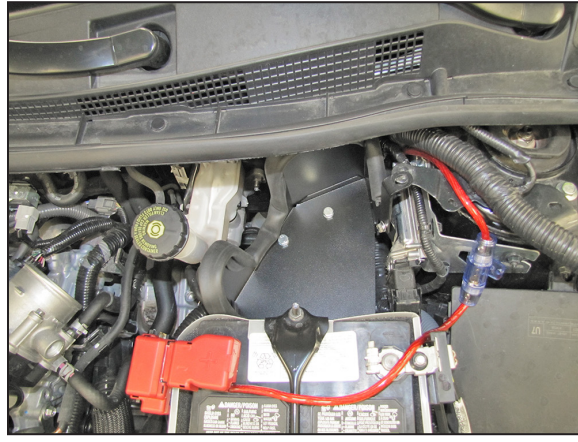

12. Install the heat shield so that the stand-offs are secure in the air box mounting grommets. Do not secure the mounting bracket at this time.

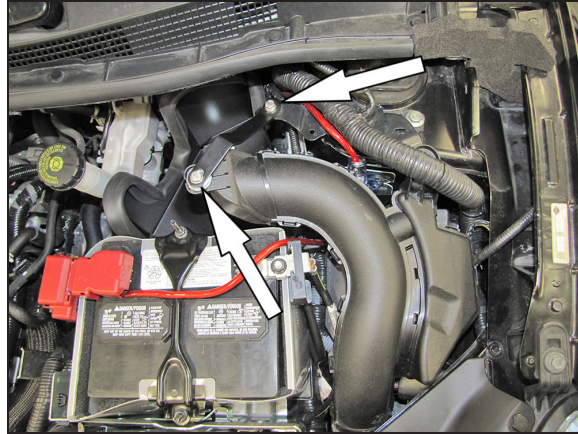

13. Reinstall the fresh air intake duct and secure the duct with the mounting bracket provided (064315) and heat shield bracket with the hardware provided.



14. Unhook the fuel line from the clip and then remove the clip from the bracket.

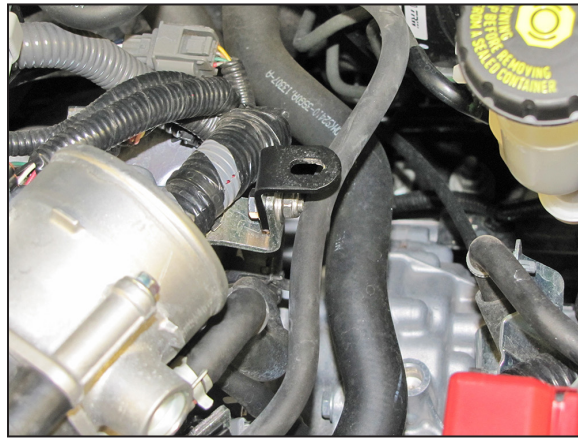

15. Install the tube mounting bracket (064314) to the clip location from the previous step and secure with the provided hardware.
NOTE: The fuel line will be secured in a later step.



16. Install the provided coupling hose (08440) onto the throttle body and secure with the provided hose clamp.

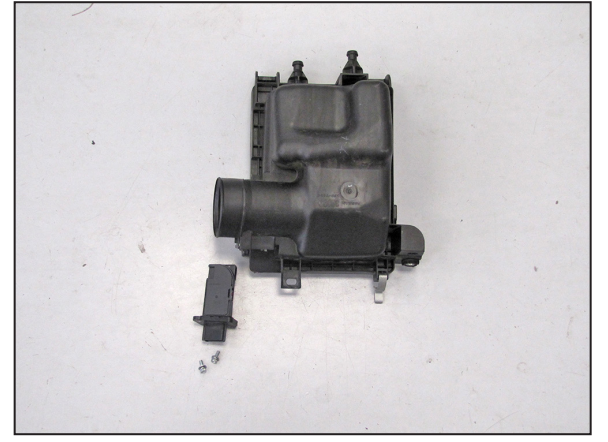

17. Remove the mass air sensor from the factory air box.



18. Install the mass air sensor into the K&N® intake tube and secure with the provided hardware.

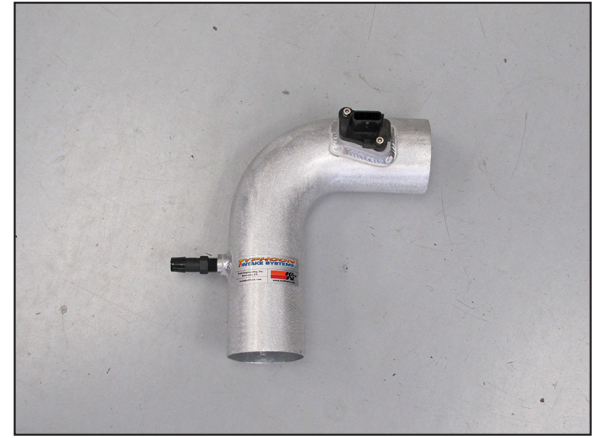

19. Install the 1/4npt fitting into the K&N® intake tube as shown.
NOTE: Plastic NPT fittings are easy to cross thread. Install the vent fitting "hand" tight, then turn it two complete turns with a wrench.



20. Install the K&N® intake tube into the hose at the throttle body and align with the mounting bracket. Secure the tube with the hardware and hose clamp.
NOTE: Secure the fuel line to the bracket with the provided tie wrap.



21. Install the hose mender into the crank case vent hose provided.

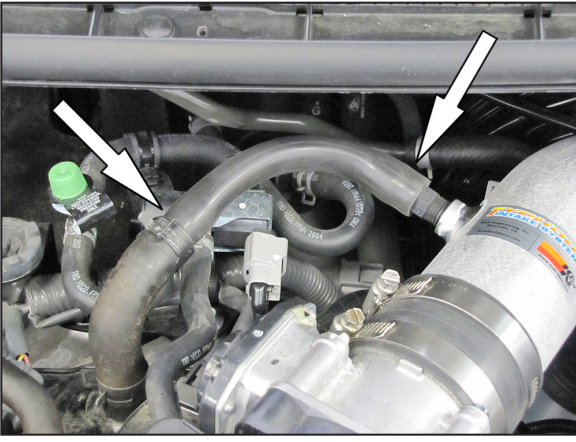

22. Install the Crank case vent hose assembly into the factory hose and secure with the factory spring clip. Then connect the open end to the fitting installed into the K&N® intake tube.

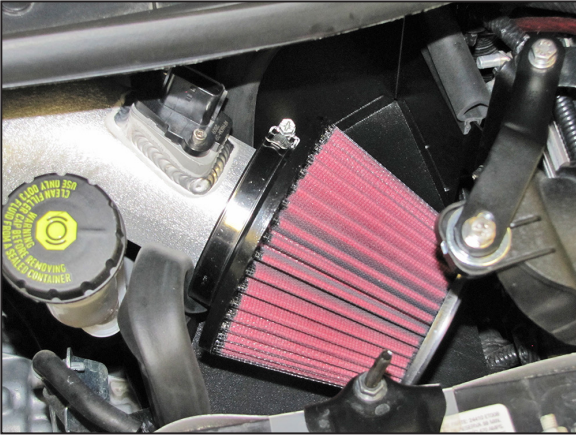

23. Install the K&N® air filter onto the intake tube and secure with the provided hose clamp.

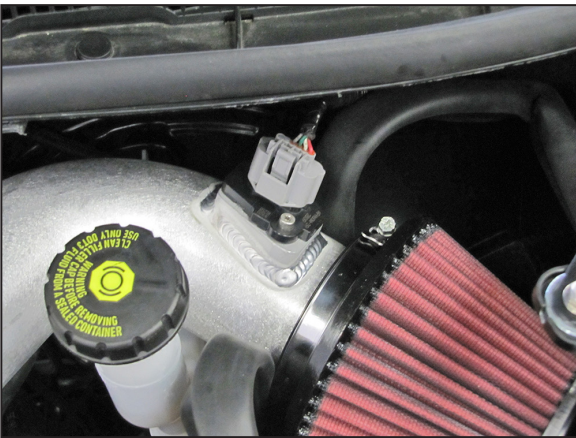

24. Reconnect the mass air sensor electrical connection.



25. Reinstall the engine cover.



26. Reconnect the vehicle's negative battery cable. Double check to make sure everything is tight and properly positioned before starting the vehicle.

27. The C.A.R.B. exemption sticker, (attached), must be visible under the hood so that an emissions inspector can see it when the vehicle is required to be tested for emissions. California requires testing every two years, other states may vary.

28. It will be necessary for all K&N® high flow intake systems to be checked periodically for realignment, clearance and tightening of all connections. Failure to follow the above instructions or proper maintenance may void warranty.

ROAD TESTING:

1. Start the engine with the transmission in neutral or park, and the parking brake engaged. Listen for air leaks or odd noises. For air leaks secure hoses and connections. For odd noises, find cause and repair before proceeding. This kit will function identically to the factory system except for being louder and much more responsive.

2. Test drive the vehicle. Listen for odd noises or rattles and fix as necessary.

3. If road test is fine, you can now enjoy the added power and performance from your kit.

4. K&N Engineering, Inc., requires cleaning the intake system's air filter element every 100,000 miles. When used in dusty or off-road environments, our filters will require cleaning more often. We recommend that you visually inspect your filter once every 25,000 miles to determine if the screen is still visible. When the screen is no longer visible some place on the filter element, it is time to clean it. To clean and re-oil, purchase our filter Recharger® service kit, part number 99-5050 or 99-5000 and follow the easy instructions.

INTAKE SYSTEMS FOR VEHICLES LISTED ARE 50 STATE LEGAL. SEE KNFILTERS.COM FOR CARB STATUS ON EACH PART FOR A SPECIFIC VEHICLE.