



TYPHOON INTAKE SYSTEMS

NOT LEGAL FOR SALE OR USE ON ANY POLLUTION CONTROLLED MOTOR VEHICLE IN CALIFORNIA OR STATES ADOPTING CALIFORNIA EMISSION PROCEDURES.
See knfilters.com for CARB status on each part for a specific vehicle

INSTALLATION INSTRUCTIONS

**69-8011TTK
SUBARU
2018-19 WRX
H4-2.0L Turbo**

TOOLS NEEDED:

- ratchet
- extension
- 10mm socket
- flat blade screw driver
- phillips screw driver
- 3mm allen key

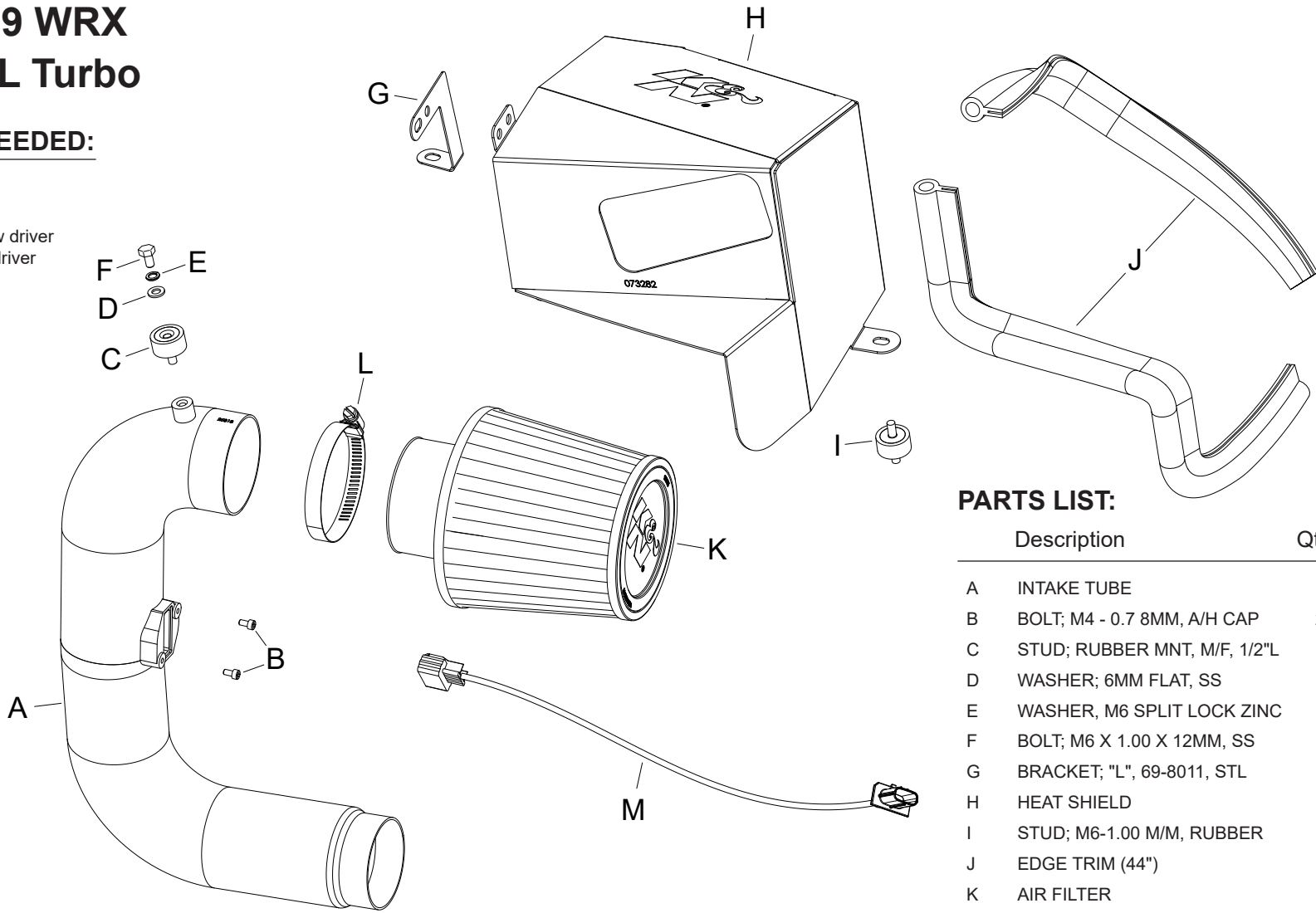

PARTS LIST:

Description	Qty.	Part #
A INTAKE TUBE	1	25818TK
B BOLT; M4 - 0.7 8MM, A/H CAP	2	07733
C STUD; RUBBER MNT, M/F, 1/2"L	1	070228
D WASHER; 6MM FLAT, SS	1	08269
E WASHER, M6 SPLIT LOCK ZINC	1	1-3025
F BOLT; M6 X 1.00 X 12MM, SS	1	07727
G BRACKET; "L", 69-8011, STL	1	064359
H HEAT SHIELD	1	073282
I STUD; M6-1.00 M/M, RUBBER	1	07027
J EDGE TRIM (44")	1	102486
K AIR FILTER	1	RU-4990
L HOSE CLAMP; #52	1	08610
M EXTENSION HARNESS; 18"	1	8-197-1

If you need any assistance please call 1-800-858-3333 to speak with a representative in our Customer Service Center before returning the product.

NOTE: FAILURE TO FOLLOW INSTALLATION INSTRUCTIONS AND NOT USING THE PROVIDED HARDWARE MAY DAMAGE THE INTAKE TUBE, THROTTLE BODY AND ENGINE.

TO START:

1. Turn off the ignition and disconnect the negative battery cable.
NOTE: Disconnecting the negative battery cable erases pre-programmed electronic memories. Write down all memory settings before disconnecting the negative battery cable. Some radios will require an anti-theft code to be entered after the battery is reconnected. The anti-theft code is typically supplied with your owner's manual. In the event your vehicles anti-theft code cannot be recovered, contact an authorized dealership to obtain your vehicles anti-theft code.

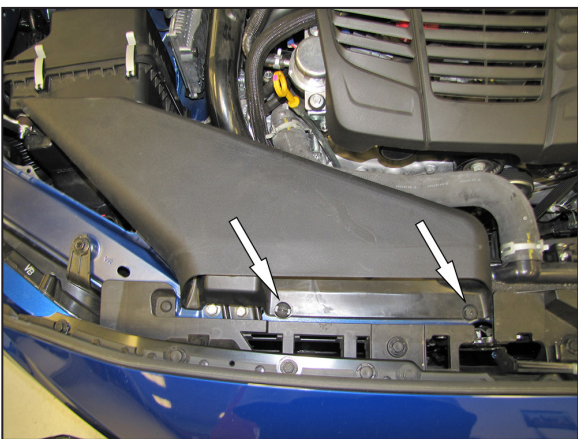

2. Remove the two retaining clips that secure the fresh air intake scoop and then remove the fresh air intake scoop from the vehicle.



3. Remove the two nuts that secure the air box bracket to the inner fender and the bolt that secures the air box to the frame rail.
NOTE: The two nuts will be reused in a later step.



4. Release the two retaining clips and then remove the front half of the air filter housing and the factory air filter.

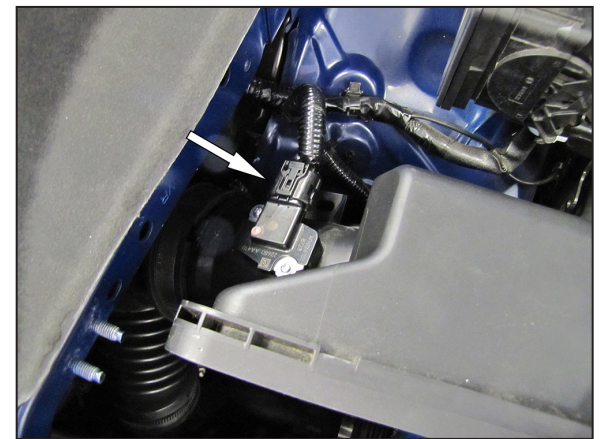

5. Disconnect the mass air sensor electrical connection.



6. Loosen the hose clamp that secures the factory intake tube to the factory turbo inlet tube and remove the nut mounting the tube to the frame.
NOTE: the nut is under the frame member. This nut will be reused in a later step.

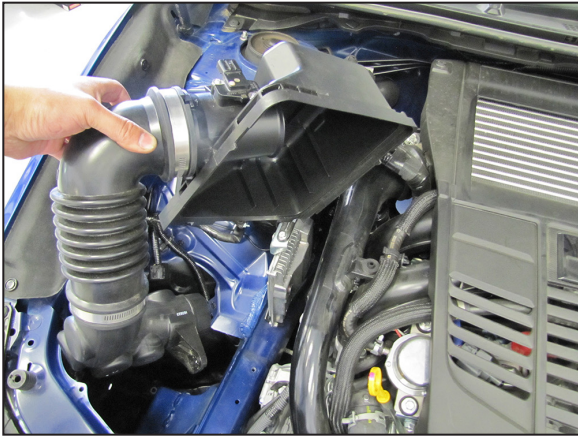

7. Separate the intake tube from the turbo inlet tube and remove the complete assembly from the vehicle.

NOTE: K&N Engineering, Inc., recommends that customers do not discard factory air intake.



8. Remove the mass air sensor from the Factory intake tube and install it in to the K&N® intake tube using the provided hardware.



9. Install the provided rubber mounted stud onto the K&N® intake as shown.



10. Install the provided tube mounting bracket (064359) onto the intake tube and secure with the provided hardware as shown.



11. Install the K&N® intake tube into the factory turbo inlet tube, align the bracket with the studs on the inner fender and then secure with the hose clamp provided.

NOTE: The bracket is not secured to the inner fender at this time.

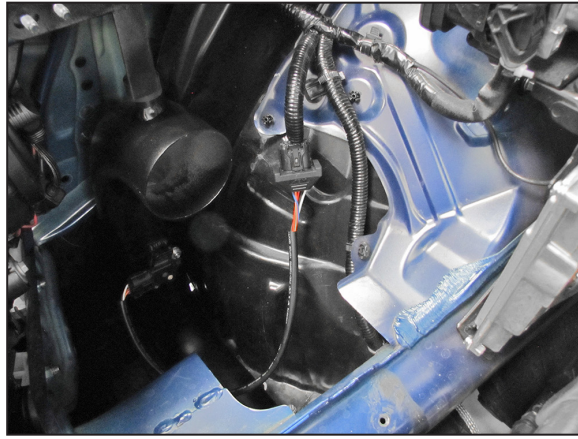

12. Connect the mass air sensor electrical connection using the provided extension harness.

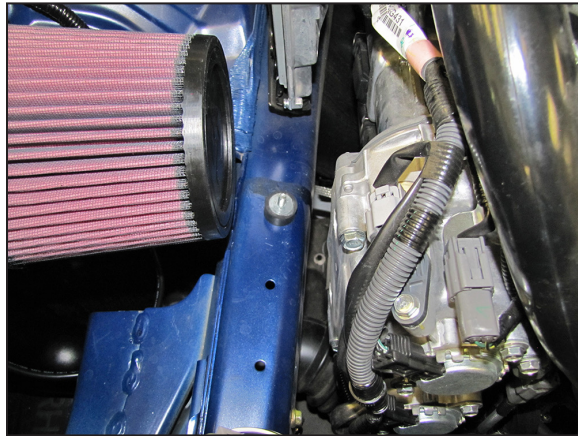

13. Install the K&N® air filter onto the intake tube and secure with the provided hose clamp. Install the provided rubber mounted stud onto the frame in the factory air filter housing mounting location as shown.

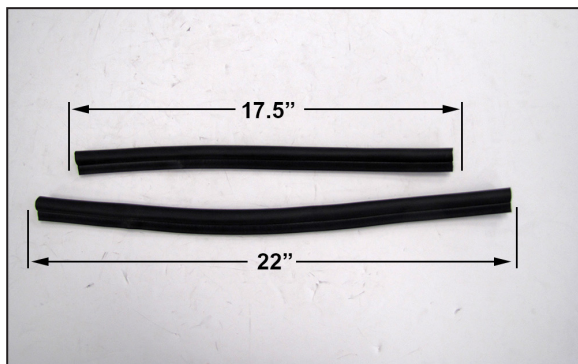

14. Cut the provided edge to the following lengths, 17.5" and 22".

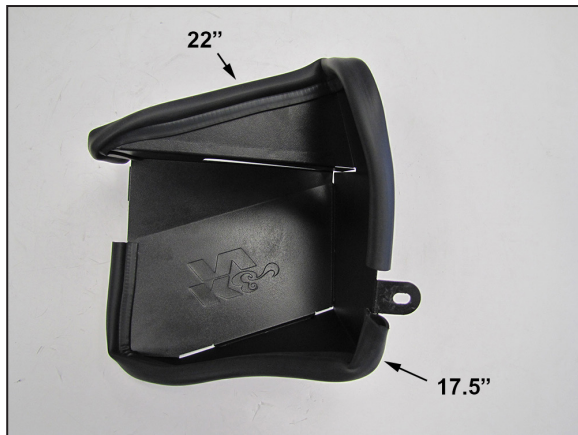

15. Install the 17.5" section to the rear edge of the heat shield and the 22" section to the front edge.



16. Install the heat shield onto the rubber mounted stud and the studs on the inner fender, secure with the factory nuts and hardware.

NOTE: The nut from step 6 will be used on the rubber mounted stud.

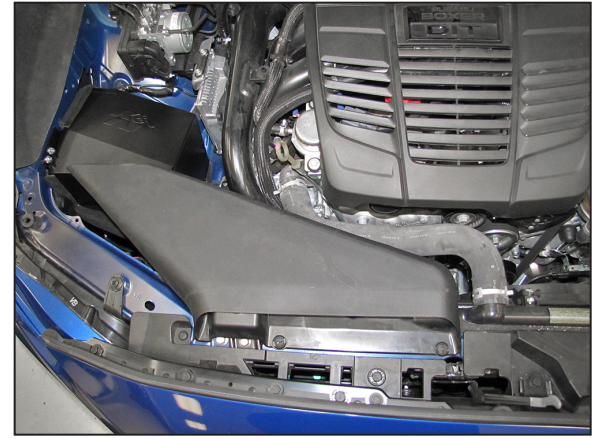

17. Reinstall the fresh air intake scoop so the outlet engages with the heat shield then secure with the factory retaining clips.

18. Reconnect the vehicle's negative battery cable. Double check to make sure everything is tight and properly positioned before starting the vehicle.

19. It will be necessary for all K&N® high flow intake systems to be checked periodically for realignment, clearance and tightening of all connections. Failure to follow the above instructions or proper maintenance may void warranty.

ROAD TESTING:

1. Start the engine with the transmission in neutral or park, and the parking brake engaged. Listen for air leaks or odd noises. For air leaks secure hoses and connections. For odd noises, find cause and repair before proceeding. This kit will function identically to the factory system except for being louder and much more responsive.

2. Test drive the vehicle. Listen for odd noises or rattles and fix as necessary.

3. If road test is fine, you can now enjoy the added power and performance from your kit.

4. K&N Engineering, Inc., requires cleaning the intake system's air filter element every 100,000 miles. When used in dusty or off-road environments, our filters will require cleaning more often. We recommend that you visually inspect your filter once every 25,000 miles to determine if the screen is still visible. When the screen is no longer visible some place on the filter element, it is time to clean it. To clean and re-oil, purchase our filter Recharger® service kit, part number 99-5050 or 99-5000 and follow the easy instructions.

NOT LEGAL FOR SALE OR USE ON ANY POLLUTION CONTROLLED MOTOR VEHICLE IN CALIFORNIA OR STATES ADOPTING CALIFORNIA EMISSION PROCEDURES.

See knfilters.com for CARB status on each part for a specific vehicle