



NOT LEGAL FOR SALE OR USE ON ANY POLLUTION CONTROLLED MOTOR VEHICLE IN CALIFORNIA OR STATES ADOPTING CALIFORNIA EMISSION PROCEDURES.

See knfilters.com for CARB status on each part for a specific vehicle

INSTALLATION INSTRUCTIONS

71-1557

DODGE

2007-09 Ram 2500 / 3500

L6-6.7L Turbo Diesel

NOTE: This kit was not designed to fit vehicles with a body lift.

TOOLS NEEDED:

Ratchet
Extension
9/16" Socket
10mm Socket
3/4" Wrench
13mm Wrench
10mm Wrench
T20 Torx
2.5 Hex Key
5mm Hex Key
Pliers.

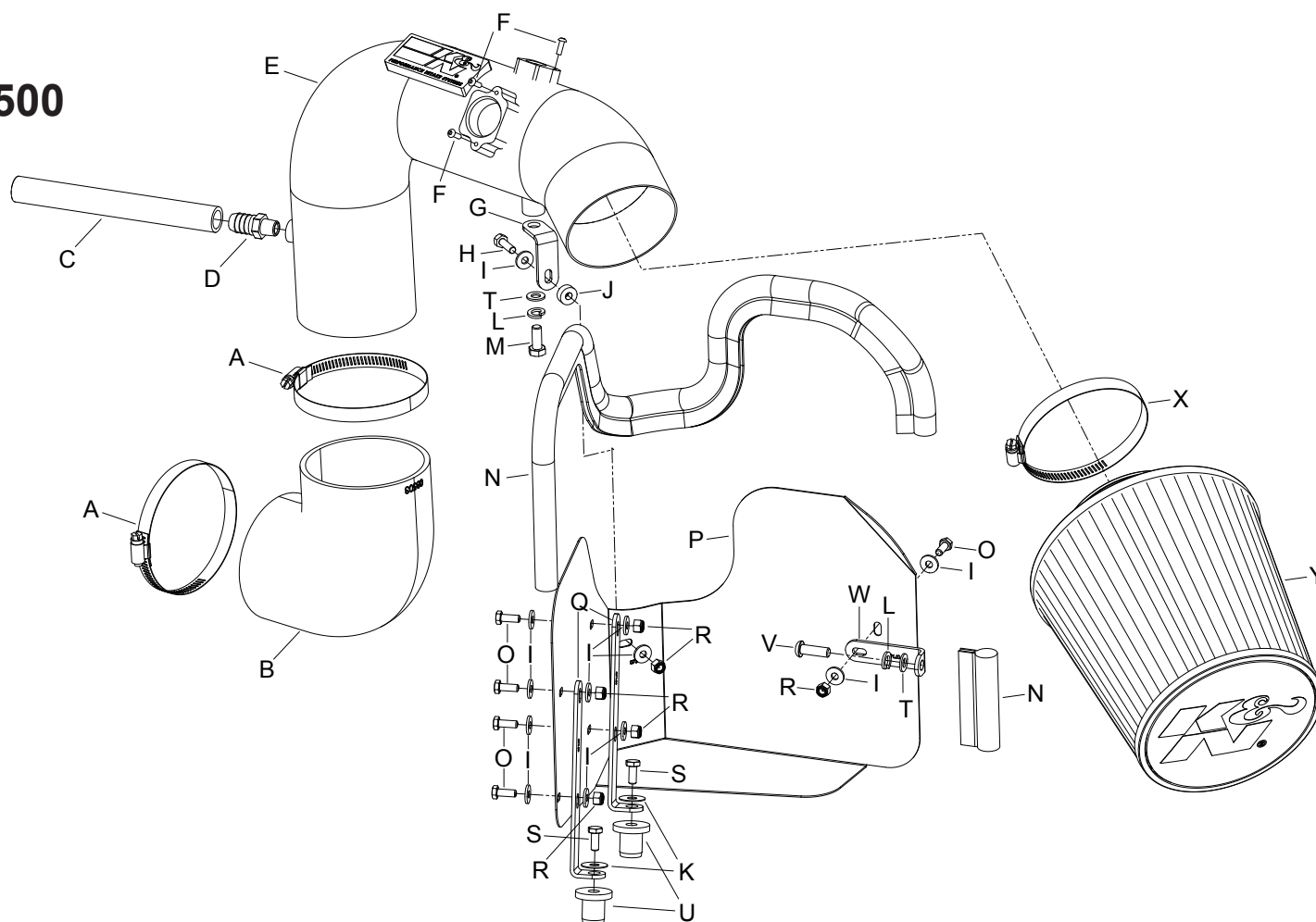

PARTS LIST:

Description	Qty.	Part #	Description	Qty.	Part #	Description	Qty.	Part #
A Hose Clamp #64, Black Zinc	2	08645K	J Spacer; .625"OD X .250"ID	1	06555	S Bolt; 3/8"-16 X 1-1/4"L SS Hex	2	07779
B Hose; 4.0"ID 90 DEG Reinforced	1	08503	K Washer; 3/8" Flat Washer, SS	2	08134	T Washer; 8MM, Flat, SS	2	08272
C Hose; 5/8"ID X 7-1/2"L	1	084008	L Washer, M8 Split Lock Zinc	2	1-3036	U Insert; 3/8-16 X 3/400 X 15/16L	2	08163
D Vent; STRT, 5/8 barbed 1/4 NPT	1	08911	M Bolt; M8-1.0 X 20MM, TAP	1	06533	V Vbolt; 8MM-1.25 X 25MM	1	07748
E Intake Tube	1	27338TK	N Edge Trim (39")	1	102496	W Bracket; 63-6015, "L" FIN, TB/PC	1	070712
F Screw; M4-.7 X 12, Buttonhead	3	07726	O Bolt; 6MM-1.00 X 16MM, SS	5	07812	X Hose Clamp #72, Black Zinc	1	08671K
G Bracket; 57-1532, SM. "L", Mild	1	07158	P Heat Shield	1	07382	Y Air Filter	1	RU-5177HBK
H Bolt; M6 X 1.00 "X 20MM Hex	1	07795	Q Bracket; 57-1532, LG. "L", Mild	2	07159			
I Washer; 1/4"ID X 5/8"OD-SAE	12	08275	R Nut; 6MM Nylock, Hexhead,SS	6	07512			

NOTE: FAILURE TO FOLLOW INSTALLATION INSTRUCTIONS AND NOT USING THE PROVIDED HARDWARE MAY DAMAGE THE INTAKE TUBE, THROTTLE BODY AND ENGINE.

TO START:

1. Turn off the ignition and disconnect the negative battery cable.

NOTE: Disconnecting the negative battery cable erases pre-programmed electronic memories. Write down all memory settings before disconnecting the negative battery cable. Some radios will require an anti-theft code to be entered after the battery is reconnected. The anti-theft code is typically supplied with your owner's manual. In the event your vehicles' anti-theft code cannot be recovered, contact an authorized dealership to obtain your vehicles anti-theft code.



2. Release the locking tab and then disconnect the mass air sensor electrical connection.

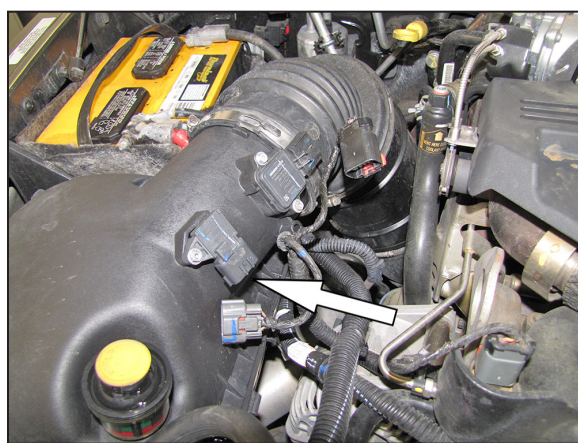

3. Disconnect the inlet air temperature sensor electrical connection and then unhook the wiring harness from the air box.

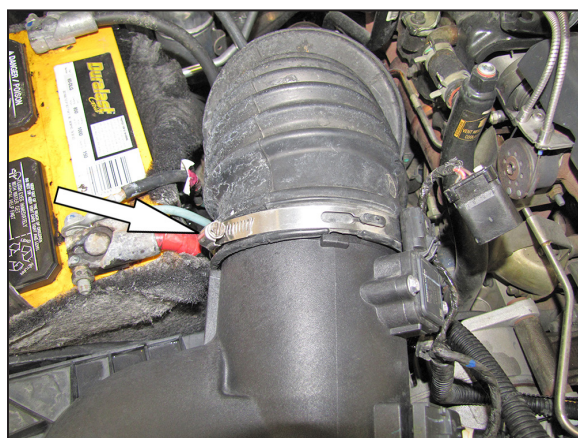

4. Loosen the hose clamp which secures the intake hose to the upper air box housing.

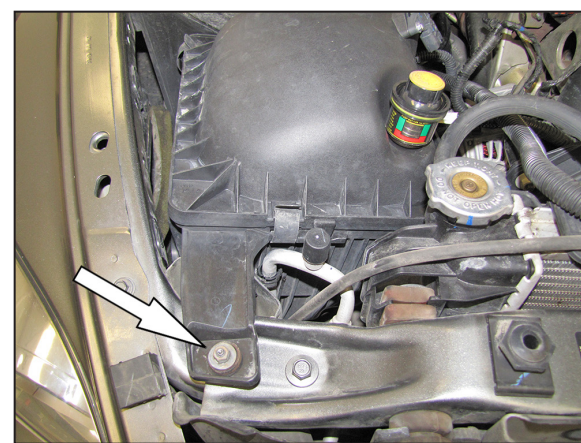

5. Loosen and remove the nut which secures the air box to the core support.



6. Remove the complete air box from the vehicle as shown.

NOTE: K&N Engineering, Inc., recommends that customers do not discard factory air intake.



7. Loosen the hose clamp securing the factory intake hose to the turbo inlet and then disconnect the crank case vent hose from the pipe. Remove the complete intake hose from the vehicle as shown.

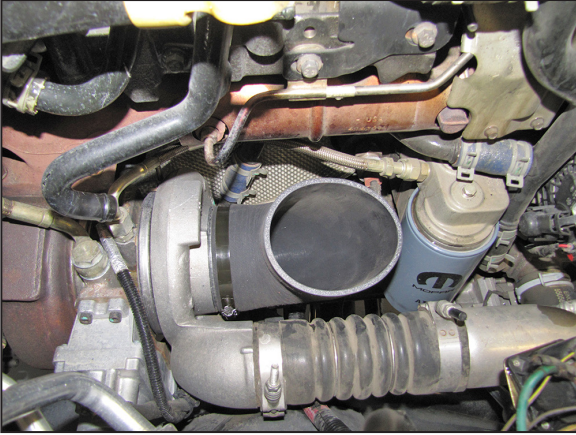

8. Install the K&N® elbow hose onto the turbo inlet and secure with the provided hose clamp.

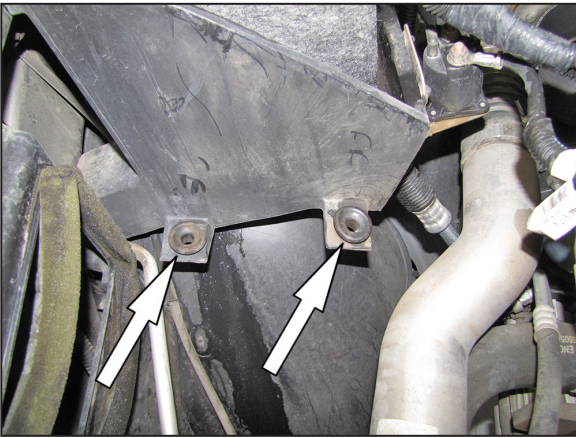

9. Remove the two air box mounting grommets shown.

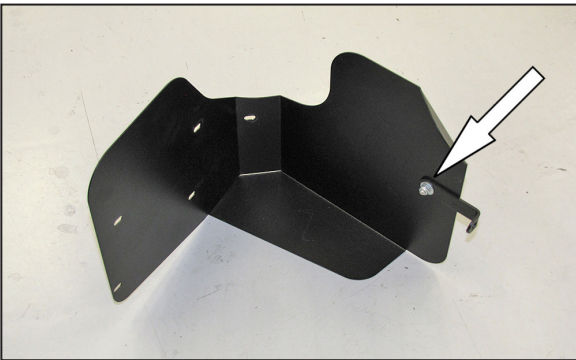

10. Install the heat shield mounting bracket (07158) onto the heat shield as shown using the provided hardware.

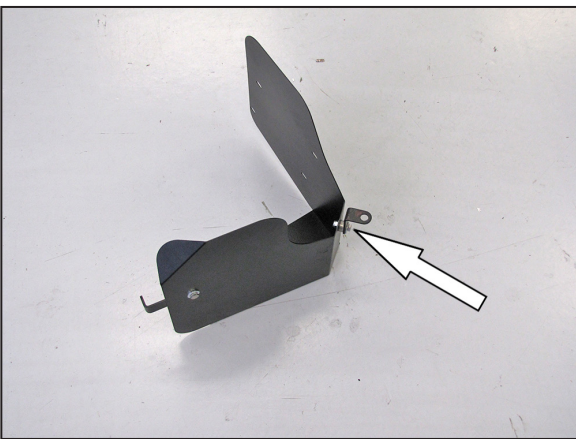

11. Install the tube mounting bracket (070712) onto the heat shield as shown using the provided hardware and spacer.

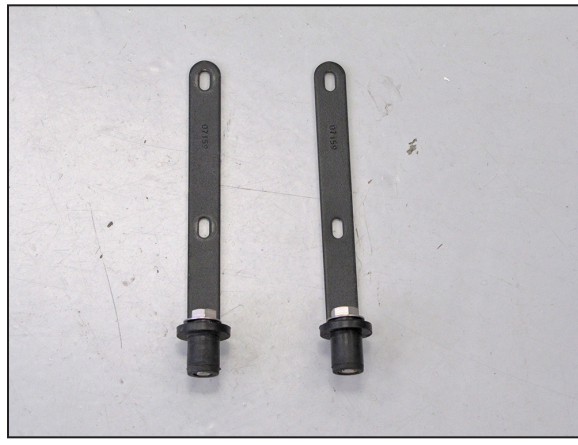

12. Install the 3/8 insert nuts onto the heat shield mounting brackets (07159) using the provided hardware.

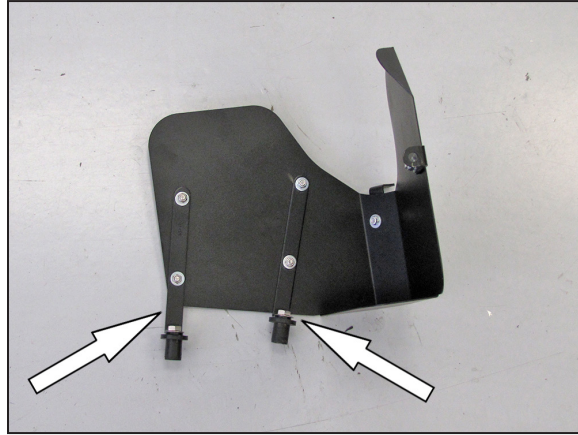

13. Install the heat shield mounting bracket assemblies (07159) onto the heat shield as shown using the provided hardware.

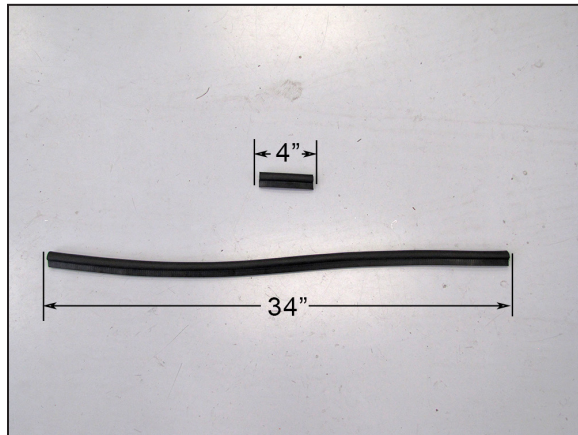

14. Cut the provided edge trim into two lengths. One length will be 34" long and one section will be 4" long.

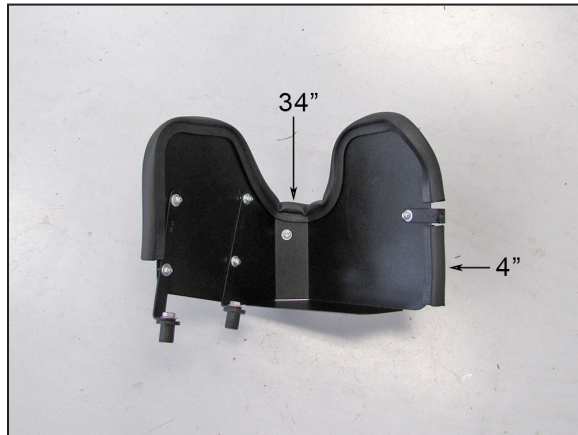

15. Install the edge trim onto the heat shield as shown.

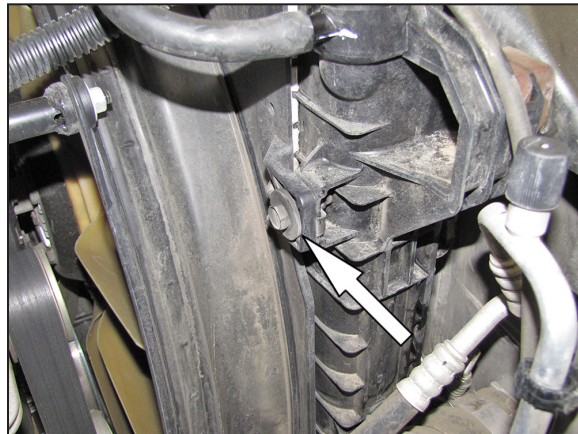

16. Remove the fan shroud bolt shown.

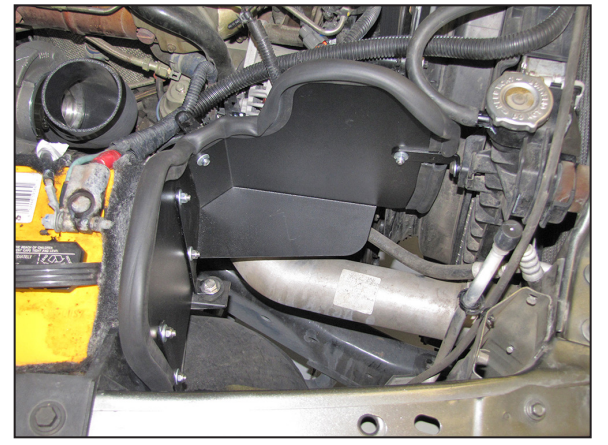

17. Set the heat shield onto the air box mounting tabs so that the inserts engage with the mounts, align the mounting bracket with the fan shroud mounting location and then secure the heat shield with the provided hardware.

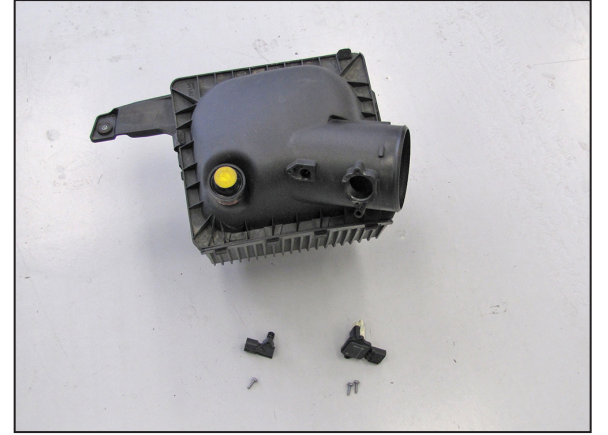

18. Remove the mass air sensor and inlet air temperature sensor from the factory air box as shown.

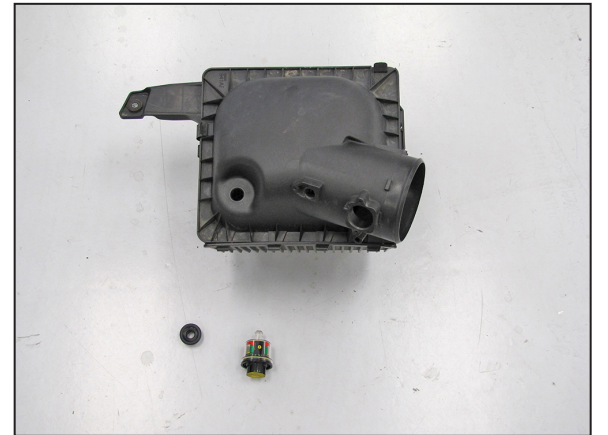

19. On vehicles equipped with a filter minder, remove the filter minder and factory grommet from the air box as shown.



20. On vehicles equipped with a filter minder, drill a 5/8" id hole into the K&N® intake tube where shown.



21. On vehicles equipped with a filter minder, install the factory grommet and filter minder into the K&N® intake tube as shown.

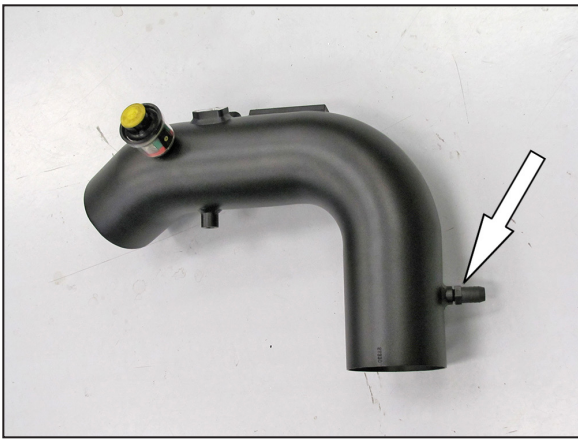

22. Install the 5/8 barb, 1/4npt crank case vent fitting provided into the K&N® intake tube as shown.



23. Install the inlet air temperature and mass air sensors into the K&N® intake tube using the provided hardware.



24. Install the K&N® intake tube assembly into the silicone hose at the turbo inlet and align with the mounting bracket installed on the heat shield. Secure the heat shield with the provided hardware and hose clamp.

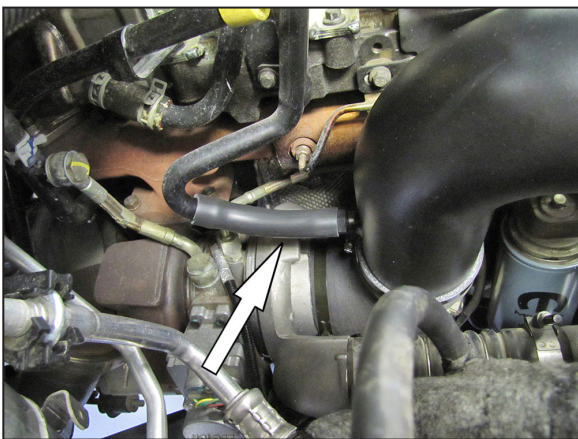

25. Install the provided crank case vent hose onto the fitting installed into the K&N® intake tube and then attach the open end to the factory vent pipe. **NOTE: Some trimming of the hose may be necessary.**

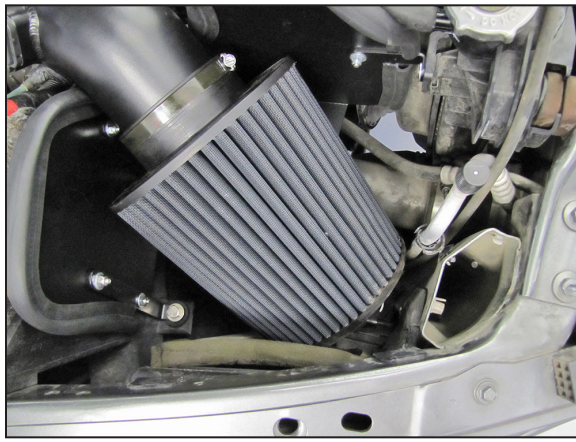

26. Install the K&N® air filter and secure with the provided hose clamp.

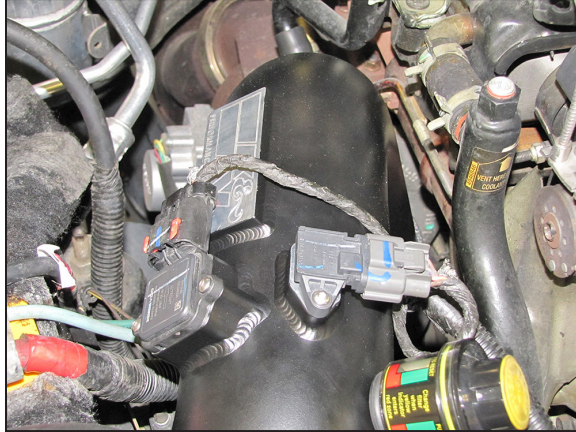

27. Reconnect the mass air sensor and inlet air temperature sensor electrical connections. **NOTE: The factory wiring harness may need to be adjusted so that the harness is not too tight.**



28. Reconnect the vehicle's negative battery cable. Double check to make sure everything is tight and properly positioned before starting the vehicle.

29. It will be necessary for all K&N® high flow intake systems to be checked periodically for realignment, clearance and tightening of all connections. Failure to follow the above instructions or proper maintenance may void warranty.

ROAD TESTING:

1. Start the engine with the transmission in neutral or park, and the parking brake engaged. Listen for air leaks or odd noises. For air leaks secure hoses and connections. For odd noises, find cause and repair before proceeding. This kit will function identically to the factory system except for being louder and much more responsive.

2. Test drive the vehicle. Listen for odd noises or rattles and fix as necessary.

3. If road test is fine, you can now enjoy the added power and performance from your kit.

4. K&N Engineering, Inc., requires cleaning the Blackhawk Induction™ intake system's air filter element every 100,000 miles. When used in dusty or off-road environments, our filters will require cleaning more often. We recommend that you visually inspect your filter once every 25,000 miles to determine if the screen is still visible. When the screen is no longer visible some place on the filter element, it is time to clean it. To clean, purchase our Synthetic Filter Cleaner, part number 99-0624 and follow the easy instructions.

NOT LEGAL FOR SALE OR USE ON ANY POLLUTION CONTROLLED MOTOR VEHICLE IN CALIFORNIA OR STATES ADOPTING CALIFORNIA EMISSION PROCEDURES.

See knfilters.com for CARB status on each part for a specific vehicle