



INTAKE SYSTEMS FOR VEHICLES LISTED ARE 50 STATE LEGAL. SEE KNFILTERS.COM FOR CARB STATUS ON EACH PART FOR A SPECIFIC VEHICLE.

INSTALLATION INSTRUCTIONS

77-2583KS
FORD
2011-14 Edge
V6-3.7
2011-13 Edge
V6-3.5

NOTE: This kit was not designed to fit vehicles with a body lift.

TOOLS NEEDED:

- Ratchet
- Extension
- 8mm socket
- 13mm wrench
- 4mm Allen
- 3mm Allen
- T20 Torx
- Flat blade screw driver.

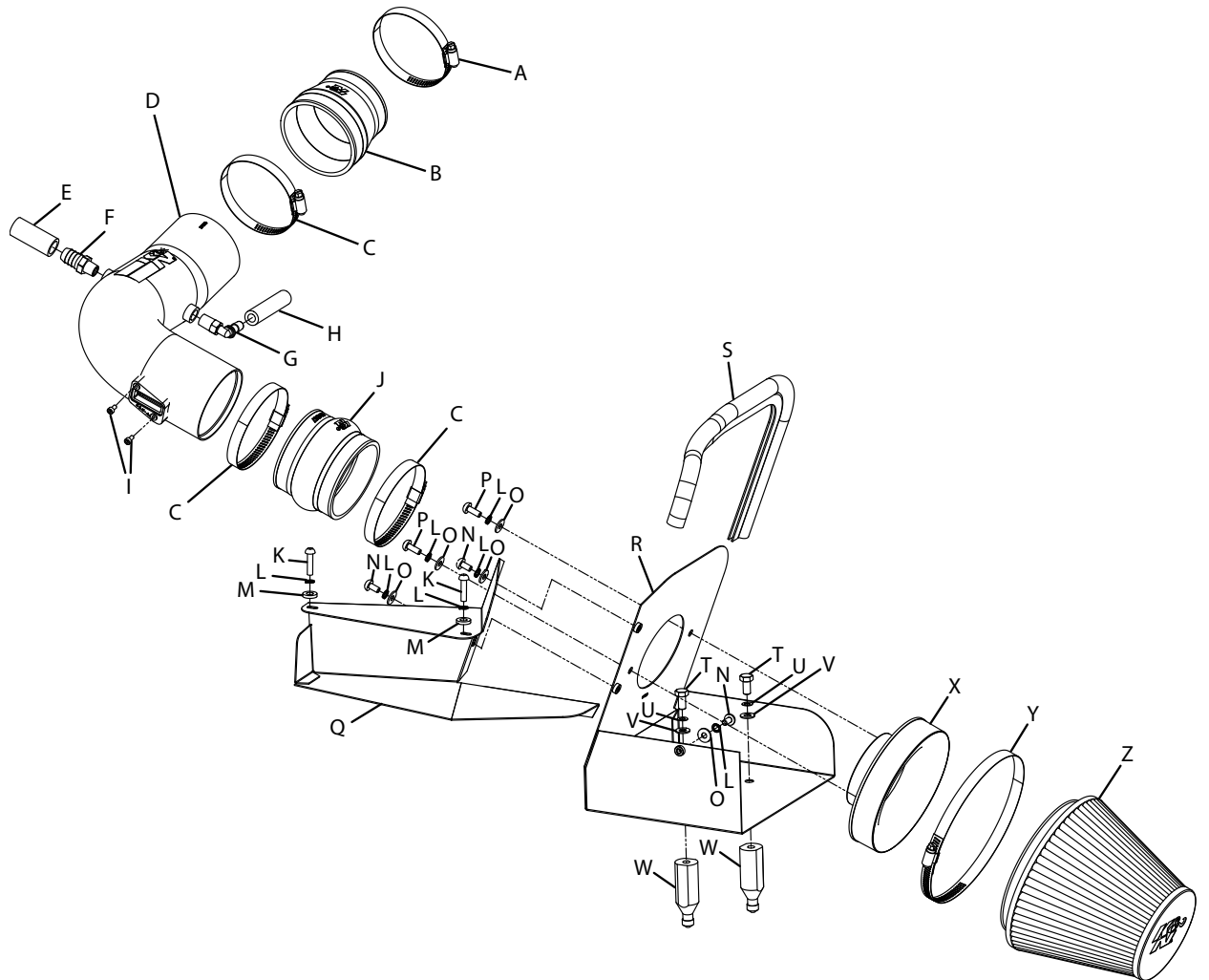

PARTS LIST:

Description	Qty.	Part #	Description	Qty.	Part #
A Hose Clamp # 52	1	08610	N Bolt; M6 X 1.00" 12MM Buttonhead, SS	3	07794
B Hose; 3-1/2" TO 3" ID X 3"L TPRD Molded	1	08724	O Washer; 6MM Flat, SS	5	08269
C Hose Clamp # 56	3	08620	P Bolt; M6 X 1.00 X 16MM, Buttonhead, SS	2	07730
D Intake Tube	1	27573KS	Q Heat Shield Scoop	1	07386
E Hose; 5/8" ID X 7-1/2" L	1	084008	R Heat Shield	1	07385
F Vent; STRT, 5/8 Barbed 1/4 NPT, Nylon	1	08911	S Edge Trim (20")	1	102494
G Vent; 1/4NPT, 90DEG, 3/8" Hose Barb, Black	1	08523	T Bolt; 8MM-1.25 X 16MM, Hexhead	2	07844
H Hose; 3/8" ID X 3"L	1	08462	U Washer; 8MM Spring (WAVE)	2	08239
I Bolt; M4- 0.07 8MM, A/H Cap, SS	2	07733	V Washer; 5/16" ID X 5/8" OD, Flat	2	08276
J Hose; 3-1/2" ID X 3"L HUMP Molded	1	084057	W Standoff; 6.0 Ford Airbox	2	06532
K Bolt; M6-1.00 X 25MM, Buttonhead, SS	2	07729	X Adapter; Universal, 6" Filter 3.5" Coupler	1	21512-1
L Washer; M6 Split Lock Zinc	7	1-3025	Y Hose Clamp # 104	1	08697
M Washer; 1/4"ID X 5/8"OD -SAE	2	08275	Z Air Filter	1	RF-1048

NOTE: FAILURE TO FOLLOW INSTALLATION INSTRUCTIONS AND NOT USING THE PROVIDED HARDWARE MAY DAMAGE THE INTAKE TUBE, THROTTLE BODY AND ENGINE.

TO START:

1. Turn off the ignition and disconnect the negative battery cable.

NOTE: Disconnecting the negative battery cable erases pre-programmed electronic memories. Write down all memory settings before disconnecting the negative battery cable. Some radios will require an anti-theft code to be entered after the battery is reconnected. The anti-theft code is typically supplied with your owner's manual. In the event your vehicles' anti-theft code cannot be recovered, contact an authorized dealership to obtain your vehicles anti-theft code.



2. Release the red locking tab and then disconnect the mass air sensor electrical connection.

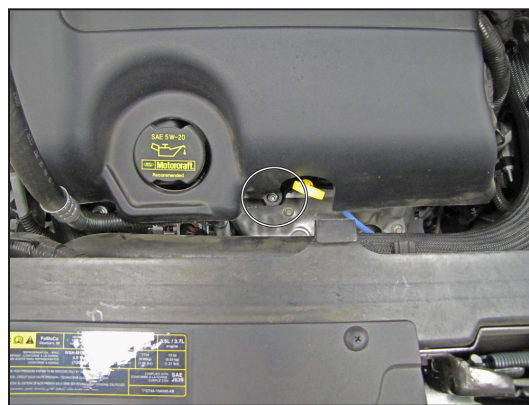

3. Remove the nut securing the front of the engine cover.



4. Remove the two push pins securing the rear of the engine cover and then remove the engine cover from the vehicle.



5. Rotate the locking tab and then disconnect the crank case vent tube from the valve cover.

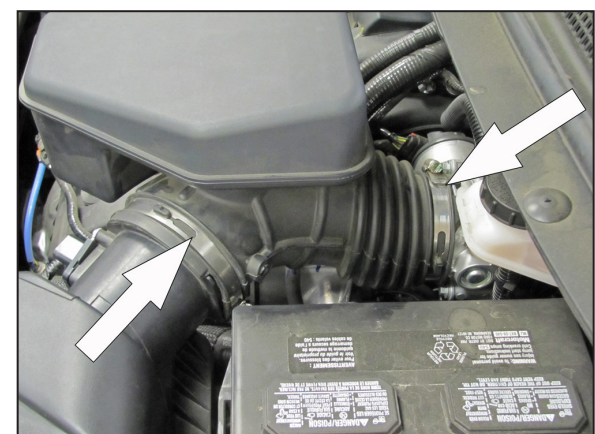

6. Loosen the two hose clamps securing the intake tube assembly to the throttle body and air filter housing.



7. Remove the intake tube assembly from the vehicle.

NOTE: Be sure to disconnect the EVAP vent line from the intake tube as it is removed.

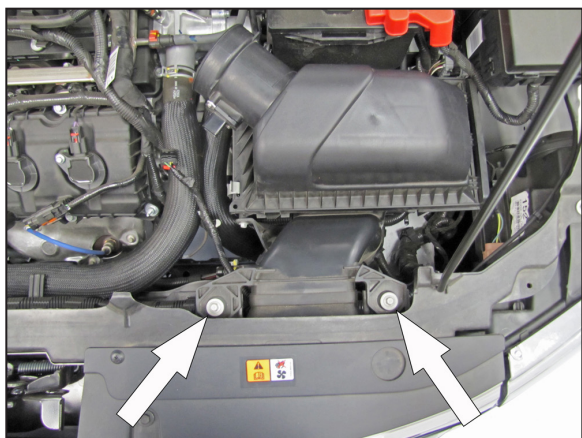

8. Remove the two bolts securing the fresh air intake scoop to the core support.



9. Lift up and remove the air box assembly from the vehicle.

NOTE: K&N Engineering, Inc., recommends that customers do not discard factory air intake.

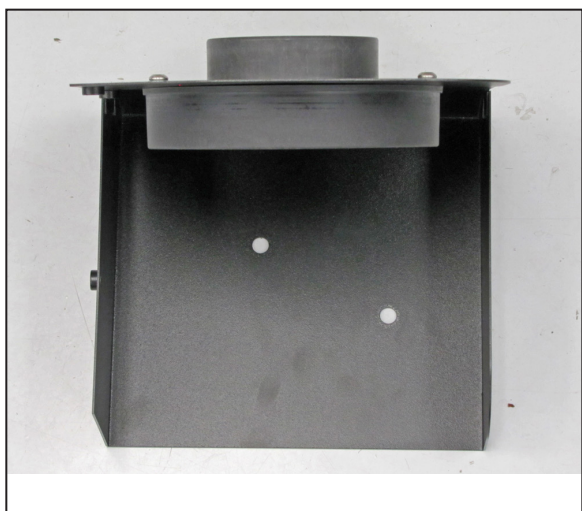

10. Install the filter adapter into the heat shield and secure with the provided hardware

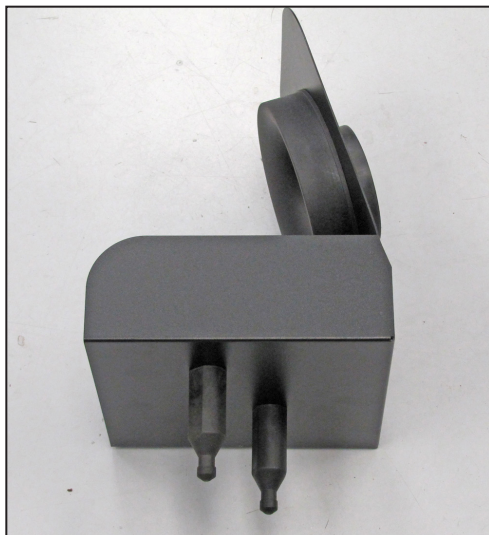

11. Install the heat shield stand-offs onto the heat shield using the provided hardware.

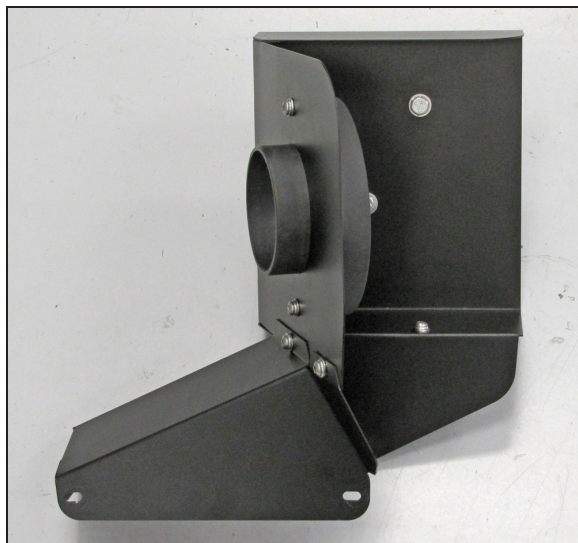

12. Install the fresh air intake scoop onto the heat shield and secure with the provided hardware.

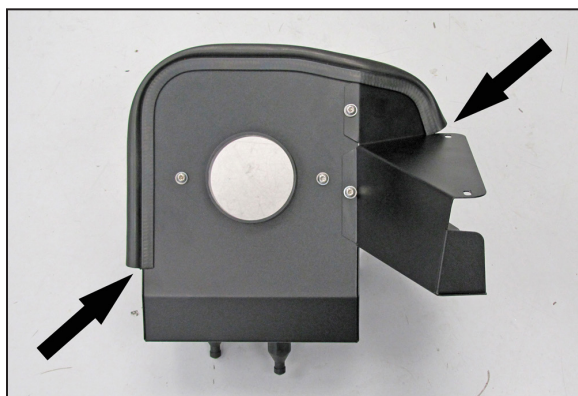

13. Install the provided edge trim onto the heat shield as shown.

NOTE: Some trimming of the edge trim will be necessary.

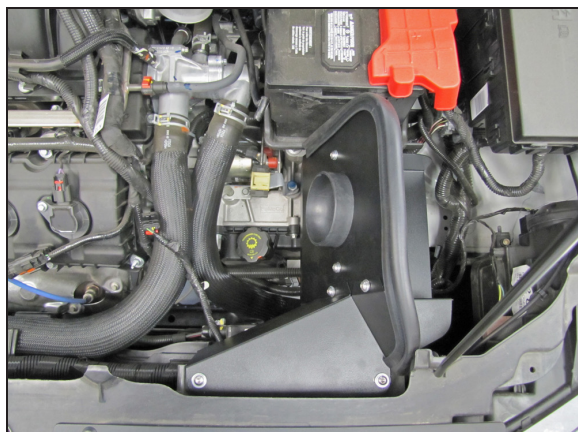

14. Install the heat shield assembly into the engine compartment so the heat shield stand-offs insert into the air box mounting grommets. Secure the fresh air intake scoop to the factory location using the provided hardware.



15. Install the 90° vent and the straight vent fitting into the K&N® intake tube as shown.

NOTE: Plastic NPT fittings are easy to cross thread. Install the vent fitting "hand" tight, then turn it two complete turns with a wrench.



16. Remove the two screws securing the mass air sensor into the factory air box and then remove the mass air sensor from the air box.



17. Install the mass air sensor into the K&N® intake tube and secure with the provide hardware.



18. Install the silicone hose (08724) onto the throttle body and secure with the provided hose clamp.



19. Install the silicone hump hose (084057) onto the K&N® intake tube as shown.

NOTE: Do not tighten the hose clamp at this time.



20. Install the K&N® intake tube into the silicone hose at the throttle body then align with the filter adapter, slide the silicone hump hose onto the filter adapter. Secure the intake tube with the provided hose clamps.

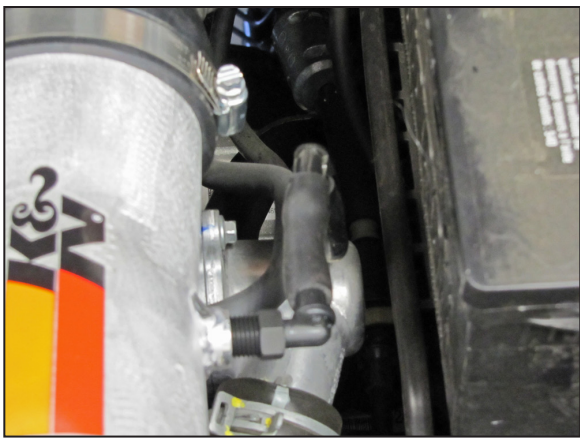

21. Using the provided 3/8" hose, connect the EVAP vent line to the 90° fitting installed into the K&N® intake tube.



22. Rotate the locking tab and then remove the crank case vent line from the factory intake tube assembly.

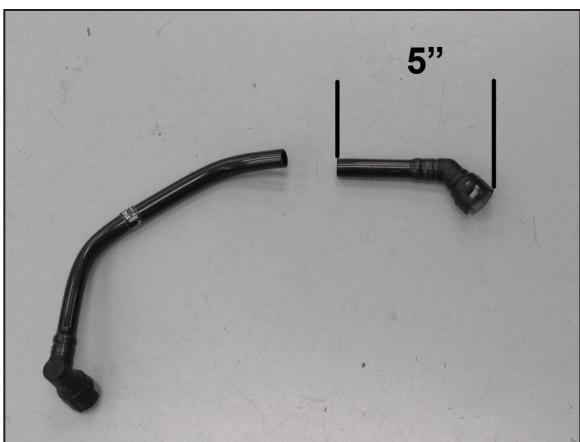

23. Measure 5" from the intake tube end of the crank case vent tube and then cut the crank case vent tube as shown.



24. Install the provided 5/8" silicone hose onto the cut factory crank case vent tube as shown.



25. Reinstall the crank case vent tube onto the valve cover port and then install the open end to the fitting installed into the K&N® intake tube as shown.

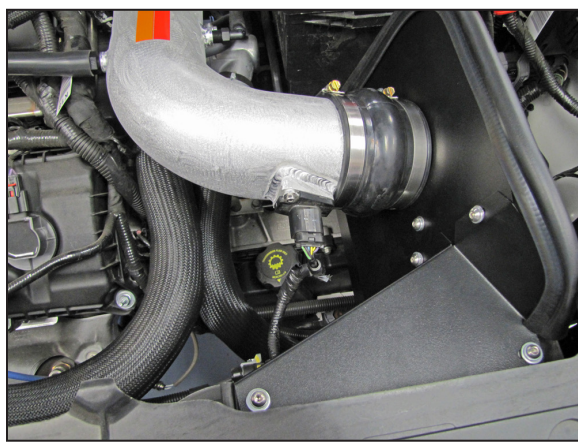

26. Reconnect the mass air sensor electrical connection.

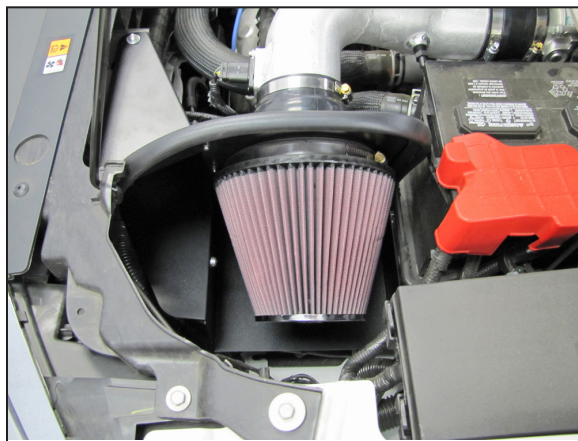

27. Install the K&N® air filter and secure with the provided hose clamp.

NOTE: Drycharger® air filter wrap; part # RF-1048DK is available to purchase separately. To learn more about Drycharger® filter wraps or look up color availability please visit <http://www.knfilters.com>®.



28. Reinstall the engine cover and secure with the factory hardware.



29. Reconnect the vehicle's negative battery cable. Double check to make sure everything is tight and properly positioned before starting the vehicle.

30. The C.A.R.B. exemption sticker, (attached), must be visible under the hood so that an emissions inspector can see it when the vehicle is required to be tested for emissions. California requires testing every two years, other states may vary.

31. It will be necessary for all K&N® high flow intake systems to be checked periodically for realignment, clearance and tightening of all connections. Failure to follow the above instructions or proper maintenance may void warranty.

ROAD TESTING:

1. Start the engine with the transmission in neutral or park, and the parking brake engaged. Listen for air leaks or odd noises. For air leaks secure hoses and connections. For odd noises, find cause and repair before proceeding. This kit will function identically to the factory system except for being louder and much more responsive.

2. Test drive the vehicle. Listen for odd noises or rattles and fix as necessary.

3. If road test is fine, you can now enjoy the added power and performance from your kit.

4. K&N Engineering, Inc., requires cleaning the intake system's air filter element every 100,000 miles. When used in dusty or off-road environments, our filters will require cleaning more often. We recommend that you visually inspect your filter once every 25,000 miles to determine if the screen is still visible. When the screen is no longer visible some place on the filter element, it is time to clean it. To clean and re-oil, purchase our filter Recharger® service kit, part number 99-5050 or 99-5000 and follow the easy instructions.

INTAKE SYSTEMS FOR VEHICLES LISTED ARE 50 STATE LEGAL. SEE KNFILTERS.COM FOR CARB STATUS ON EACH PART FOR A SPECIFIC VEHICLE.