



LEGAL IN CALIFORNIA ONLY FOR RACING VEHICLES WHICH MAY NEVER BE USED, REGISTERED OR LICENSED FOR USE UPON A HIGHWAY.  
See knfilters.com for CARB status on each part for a specific vehicle

## INSTALLATION INSTRUCTIONS

### 77-9027KP TOYOTA 2005-06 Tundra 2005-07 Sequoia V8-4.7L

NOTE: This kit was not designed to fit vehicles with a body lift.

#### TOOLS NEEDED:

9/64" allen wrench  
2.5mm allen  
4mm socket  
10mm socket  
10mm wrench  
extension  
phillips screwdriver  
ratchet

#### PARTS LIST:

Description	Qty.	Part #	Description	Qty.	Part #	Description	Qty.	Part #
A Hose Clamp #56	4	08620	H Washer; 1/4" Lock, ZN	1	08198	O Stud; M6-1.00 /M Rubber Mntd.	3	07027
B Hose; 3-1/2", Angled Silicone	1	084088	I Washer; 1/4"ID x 5/8"OD - SAE	7	08275	P Nut; 6mm Nylock, Hex.	5	07553
C Intake Tube	1	27417	J Bracket	1	083113	Q Adapter #380	1	21512-1
D Hose; 1/2"ID x 14"L, Silicone	1	08402	K Hose; 3-1/2" x 2"L	1	08698	R Hose Clamp #104	1	08697
E Hose; 18" 4MM	1	08153	L Heat Shield	1	07433	S Air Filter	1	RF-1042
F Screw; M4-.7x12, Button Head	2	07726	M Edge Trim 61"	1	102492			
G Bolt; M6-1.00 x 16MM Hex.	2	07703	N Bracket; Angled	1	070581			

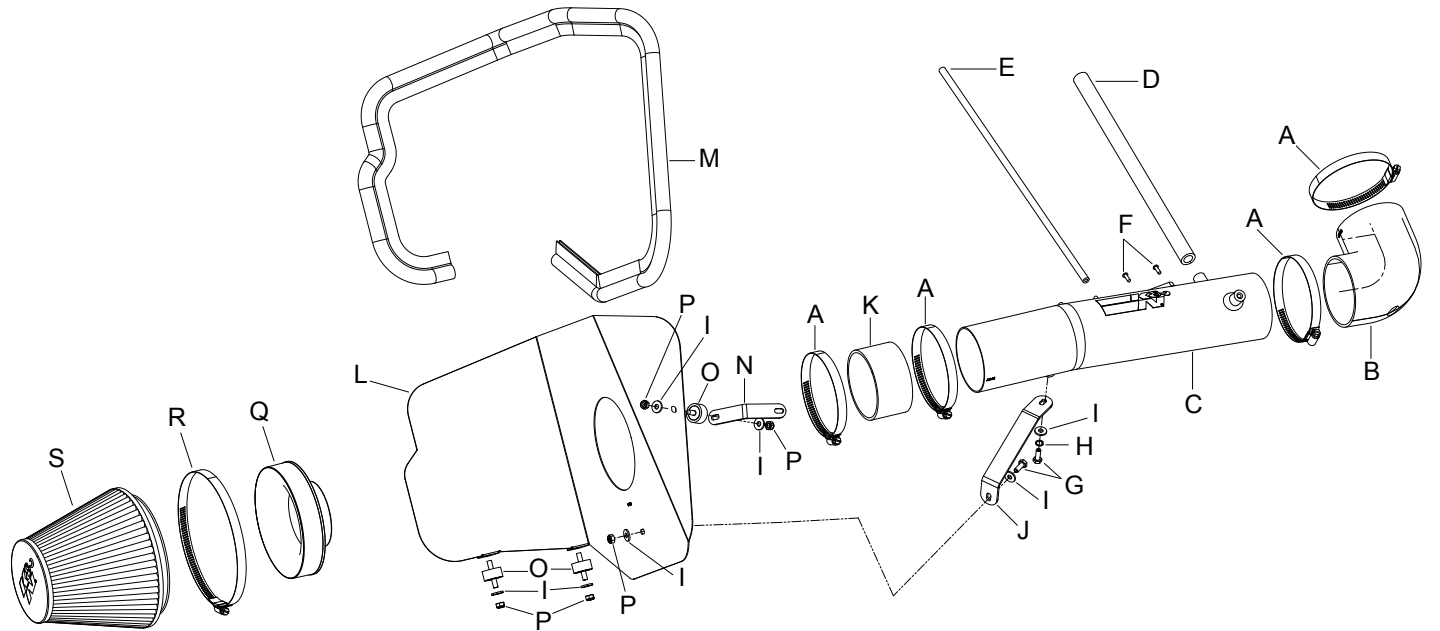

**NOTE: FAILURE TO FOLLOW INSTALLATION INSTRUCTIONS AND NOT USING THE PROVIDED HARDWARE MAY DAMAGE THE INTAKE TUBE, THROTTLE BODY AND ENGINE.**

#### TO START:

1. Turn off the ignition and disconnect the negative battery cable.

NOTE: Disconnecting the negative battery cable erases pre-programmed electronic memories. Write down all memory settings before disconnecting the negative battery cable. Some radios will require an anti-theft coded to be entered after the battery is reconnected. The anti-theft code is typically supplied with your owner's manual. In the event your vehicles' anti-theft code cannot be recovered, contact an authorized dealership to obtain your vehicles anti-theft code.



2. Disconnect the mass air sensor electrical connection.

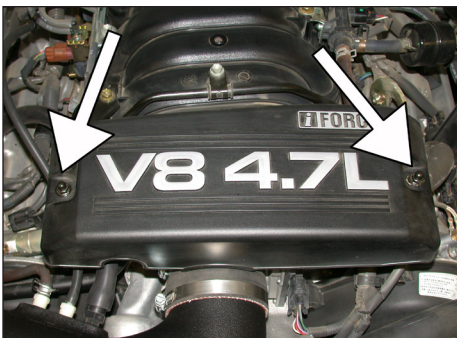

3. Loosen and remove the nuts shown that secure the throttle body cover, then remove the throttle body cover from the engine.

NOTE: The mounting nuts will be reused.

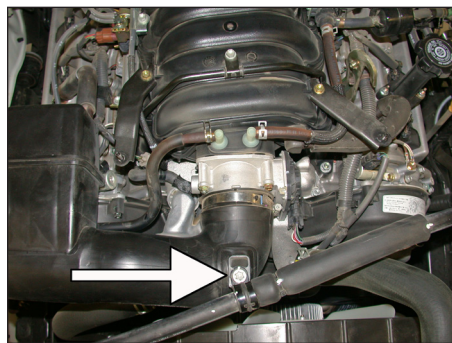

4. Loosen and remove the bolt that secures the A/C hose to the stock intake tube.

NOTE: This bolt will be reused in a later step.



5. Loosen the hose clamp, which secures the stock intake tube to the throttle body.

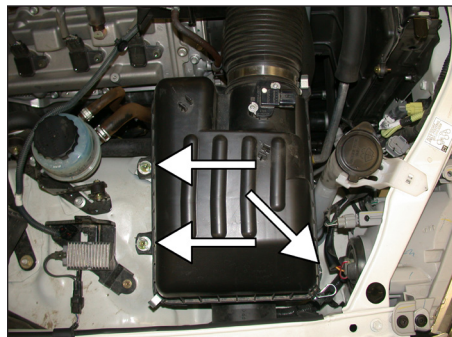

6. Loosen the three bolts that secure the stock air box assembly to the inner fender.

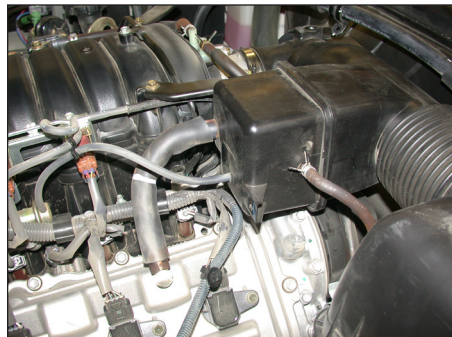

7. Disconnect the three vacuum lines shown from the stock intake tube.



8. Remove the complete intake assembly from the vehicle as shown.

NOTE: K&N Engineering, Inc., recommends that customers do not discard factory air intake.



9. Remove the two screws which secure the mass air sensor to the factory air box, then remove the mass air sensor from the air box as shown.



10. Install the mass air sensor into the K&N® intake tube and secure with the provided hardware as shown.



11. Install the provided edge trim onto the heat shield as shown.

**NOTE: Some trimming of the edge trim may be necessary.**



12. Install the rubber mounted stud onto the heat shield as shown using the provided hardware.



13. Install the provided bracket (070581) onto the rubber mounted stud installed in step #12. Do not tighten completely at this time.



14. Install the two rubber mounted studs to the original air box mounting holes as shown.



15. Remove the radiator fan shroud upper mounting bolt shown.

**NOTE: This bolt will be reused.**



16. Install the heat shield assembly onto the rubber mounted studs installed in step #14. Secure with the provided hardware.

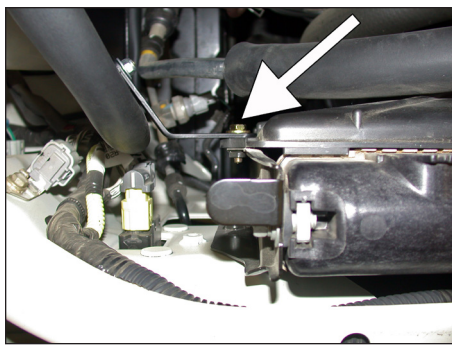

17. Secure the heat shield bracket to the radiator fan shroud with the bolt removed in step #15.

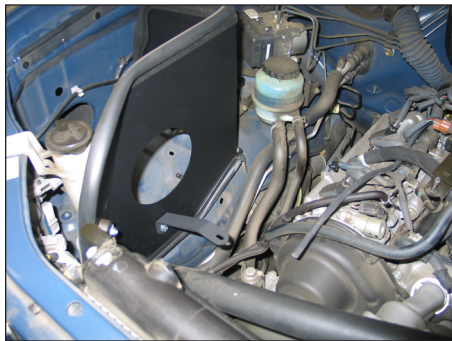

17a. Install the tube mounting bracket (083113) onto the heat shield as shown using the provided hardware.



18. Install the silicone hose (084088) onto the throttle body and secure with the provided hose clamp as shown.



19. Install the intake tube onto the throttle body and align the tube mounting bracket with the threaded boss on the engine, then secure with the provided hardware.



20. Attach the A/C hose to the intake tube with the bolt removed in step #4.



21. Remove the factory crankcase vent hose and fuel pressure regulator vent hose shown from the engine.

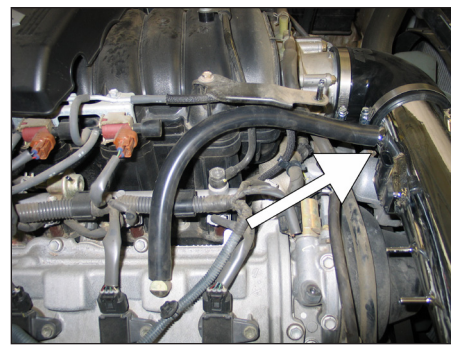

22. Install the provided crankcase vent hose onto the valve cover and then attach to the intake tube as shown.

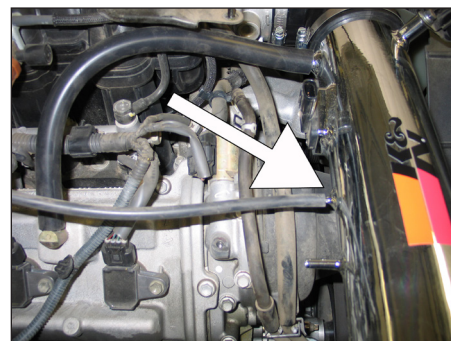

23. Install the provided fuel pressure regulator vent hose onto the fuel pressure regulator and then attach to the K&N® intake tube as shown.



24. Attach the power steering pressure switch vent hose to the K&N® intake tube as shown.



25. Install the filter adapter into the air filter as shown and secure with the provided hose clamp.  
**NOTE: Drycharger® air filter wrap; part number RF-1042DK is available to purchase separately. To learn more about Drycharger® filter wraps or look up color availability please visit <http://www.knfilters.com>®.**



26. Install the silicone hose (08698) onto the filter adapter as shown and secure with the provided hose clamp.



27. Install the air filter assembly onto the K&N® intake tube and secure with the provided hose clamp.

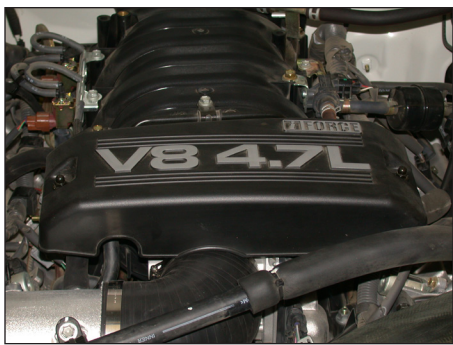

28. Reinstall the engine cover and secure it with the factory mounting nuts removed in step #3.

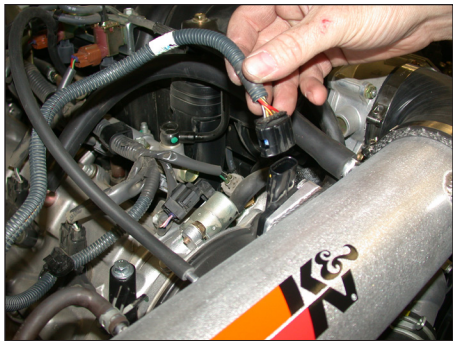

29. Reconnect the mass air sensor electrical connection as shown.

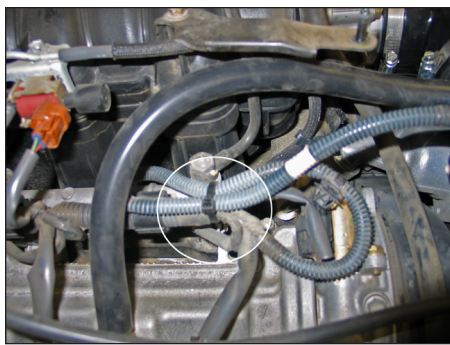

30. Using the provided wire tie, secure the excess mass air wire to the tube-mounting bracket as shown.



31. Reconnect the vehicle's negative battery cable. Double check to make sure everything is tight and properly positioned before starting the vehicle.

32. It will be necessary for all K&N® high flow intake systems to be checked periodically for realignment, clearance and tightening of all connections. Failure to follow the above instructions or proper maintenance may void warranty.

#### ROAD TESTING:

1. Start the engine with the transmission in neutral or park, and the parking brake engaged. Listen for air leaks or odd noises. For air leaks secure hoses and connections. For odd noises, find cause and repair before proceeding. This kit will function identically to the factory system except for being louder and much more responsive.

2. Test drive the vehicle. Listen for odd noises or rattles and fix as necessary.

3. If road test is fine, you can now enjoy the added power and performance from your kit.

4. K&N Engineering, Inc., suggests checking the air filter element periodically for excessive dirt build-up. When the element becomes covered in dirt (or once a year), service it according to the instructions on the Recharger® service kit, part number 99-5050 or 99-5000.

**LEGAL IN CALIFORNIA ONLY FOR RACING VEHICLES WHICH MAY NEVER BE USED, REGISTERED OR LICENSED FOR USE UPON A HIGHWAY.**

See [knfilters.com](http://knfilters.com) for CARB status on each part for a specific vehicle