



Equipped with AEM® Dryflow™ Filter
No Oil Required!

INSTALLATION INSTRUCTIONS

PART NUMBER:

21-712C

(Gun Metal Grey Finish)

21-712P

(Vacuum Metalized Chrome - VMC)

2011-2014 NISSAN Maxima V6-3.5L C.A.R.B. E.O. # D-670-21

PARTS LIST

Description	Qty.	Part Number		
A	1	20-499	R	Edge Trim, 30"
B	1	2-1481C/P	S	Bracket; Nissan Maxima Scoop 2, Tb/pc
C	1	21-2110DK	T	Hose Clamp #10 Mini
D	1	784640	U	Scoop; Nissan Maxima
E	1	5-351	V	Bracket, 07 Altima H/s Rear
F	4	9456	W	Bracket; Nissan Maxima Scoop 1, Tb/pc
G	1	5-7021	X	Bolt; Hex/flange M6-1.0 X 12
H	5	444.460.04	Y	Edge Trim, 6"
I	9	08160	Z	Edge Trim, 8"
J	1	2-4992C/AP		
K	1	5-325		
L	2	9452		
M	2	1-2065		
N	1	5-357		
O	1	2-620		
P	2	2-670		
Q	2	1-2002		

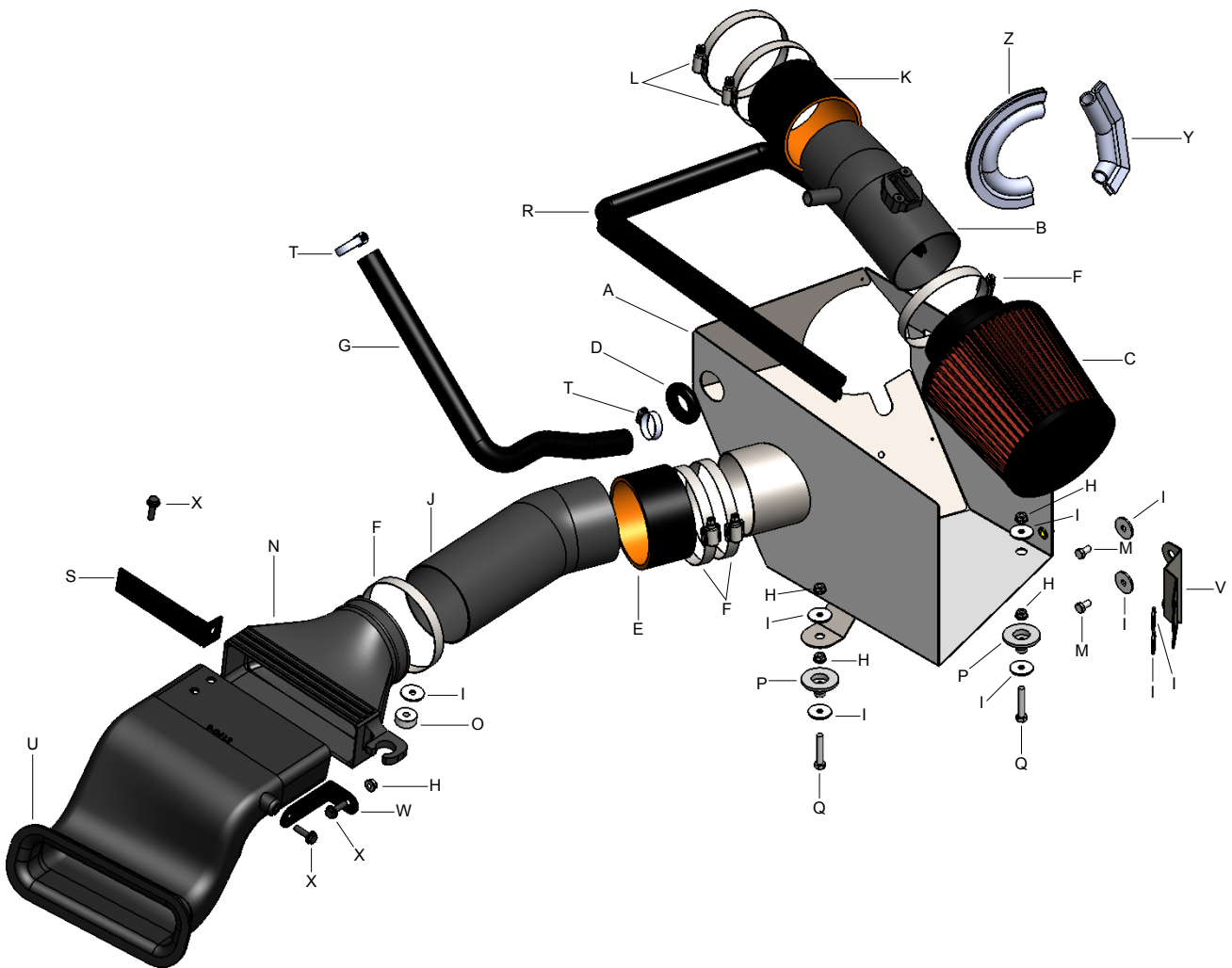

Read and understand these instructions **BEFORE** attempting to install this product. Failure to follow installation instructions and not using the provided hardware may damage the intake tube, throttle body and engine.

The AEM® intake system is a performance product that can be used safely during mild weather conditions. During harsh and inclement weather conditions, you must return your vehicle to stock OEM airbox and intake tract configuration. Failure to follow these instructions will void your warranty.

1. Preparing Vehicle

- a. Make sure vehicle is parked on level surface.
- b. Set parking brake.
- c. If engine has run in the past two hours, let it cool down.
- d. Disconnect negative battery terminal.
- g. Do not discard stock components after removal of the factory system.

2. Removal of stock system

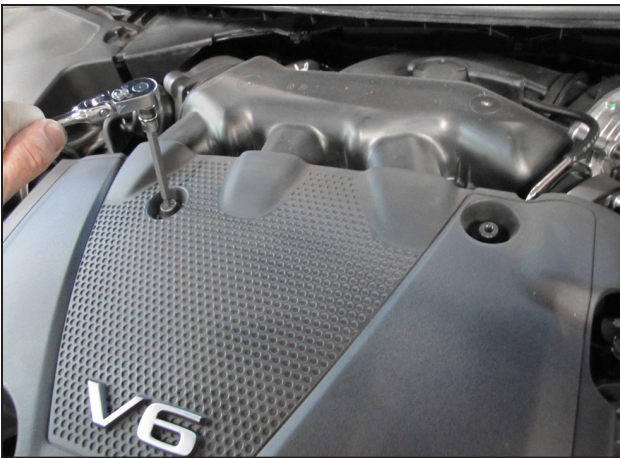

a. Remove the two 5mm Allen head bolts that secure the valve cover in place.



b. Lift up on the bottom of the engine cover and remove from the vehicle.

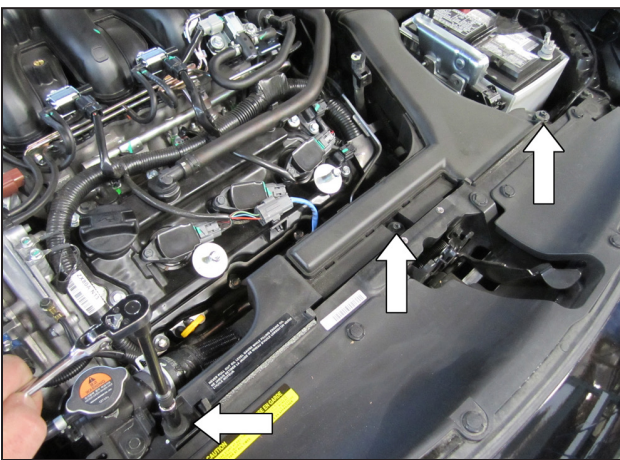

c. Remove the 3 bolts securing the stock intake scoop.

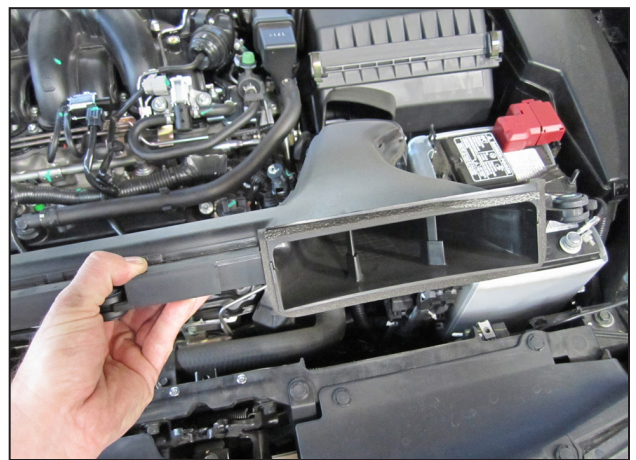

d. Remove the stock intake scoop from the vehicle.

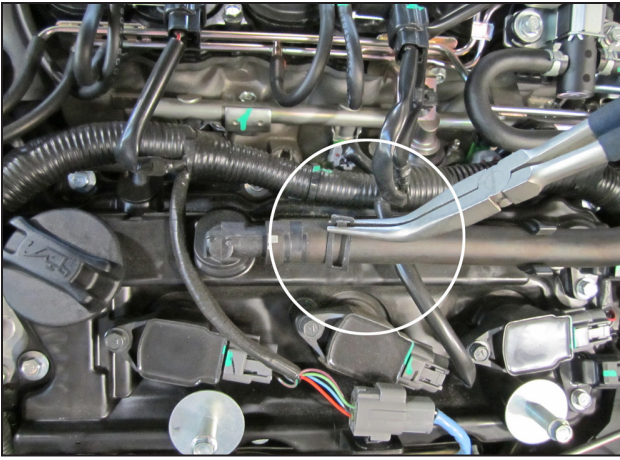

e. Remove the spring clamp securing the PCV hose to the valve cover vent.

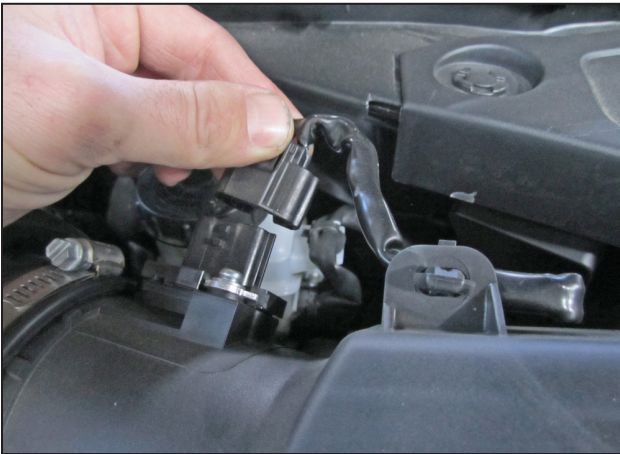

g. Unplug the MAF sensor connector.



i. Remove the 10mm bolt that secures the lower air box in place.

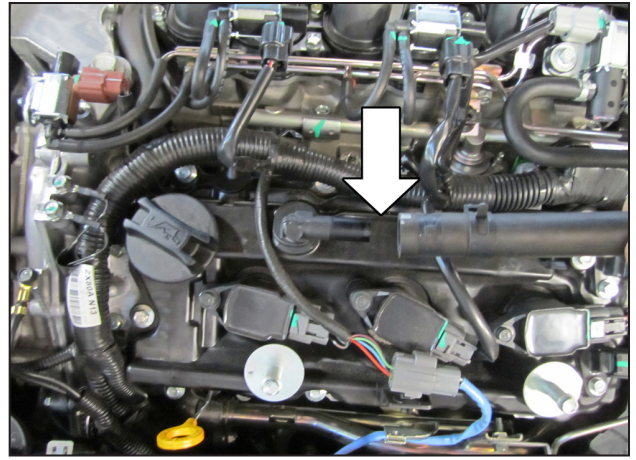

f. Remove the hose from the valve cover vent.

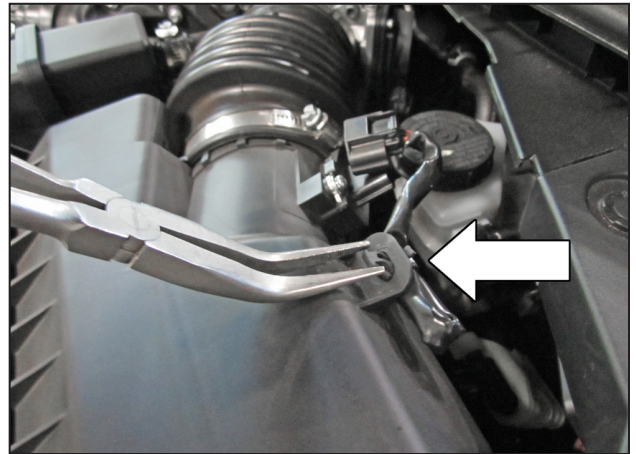

h. Release the clip securing the MAF sensor harness to the air box.

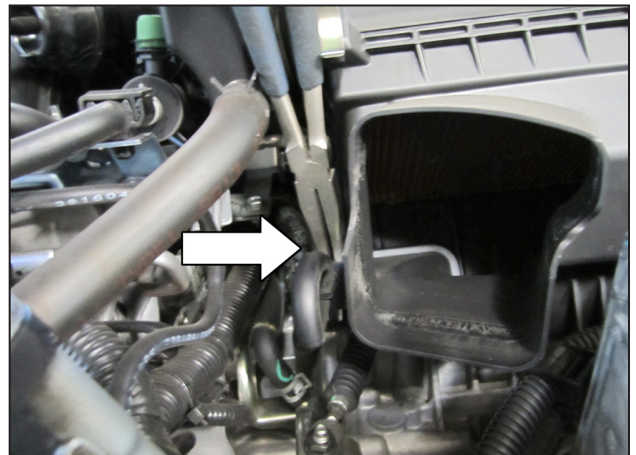

j. Remove the clip securing the transmission breather to the factory air box.



k. Loosen the hose clamp that secures the inlet tube to the throttle body.

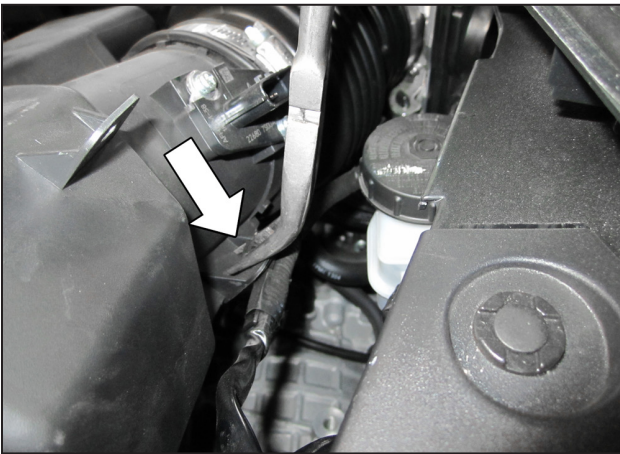

m. Remove the 2nd MAF harness clip from the back side of the air box.

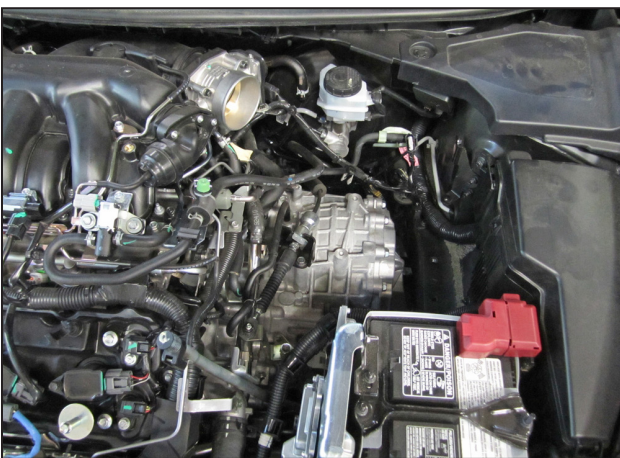

o. Remove the factory air box system from the vehicle.

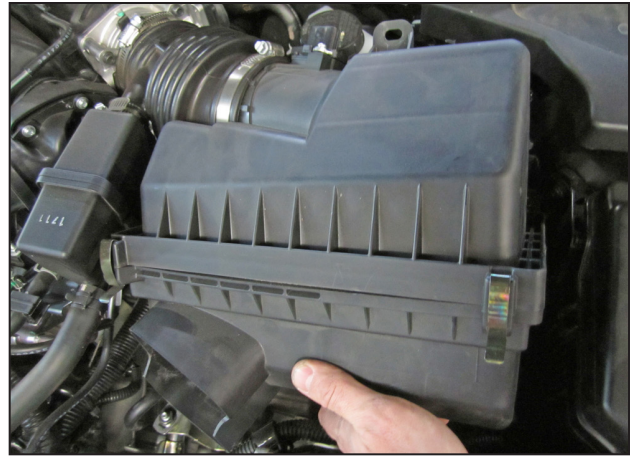

l. Lift up on the bottom of the air box to disengage but do not remove from engine bay.

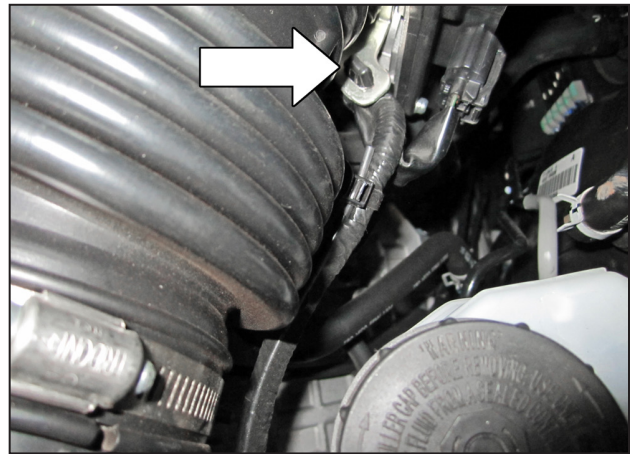

n. Remove the 3rd MAF harness clip from the inlet tube.

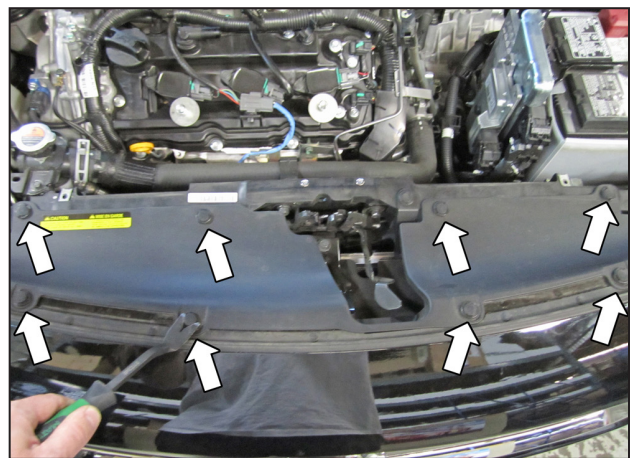

p. Remove the 8 clips from the front of the upper radiator shroud.

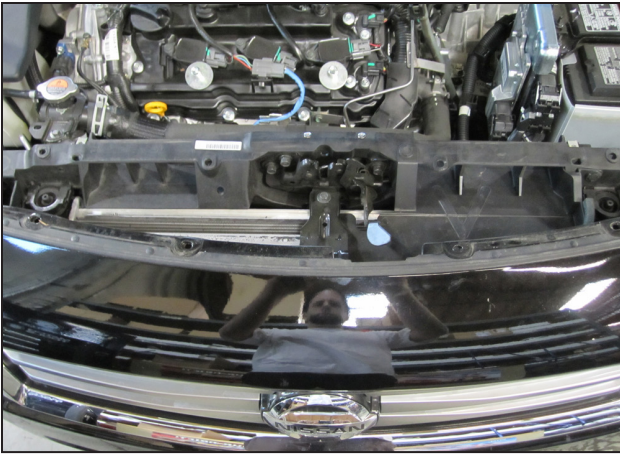

q. Remove the upper radiator shroud from the vehicle.

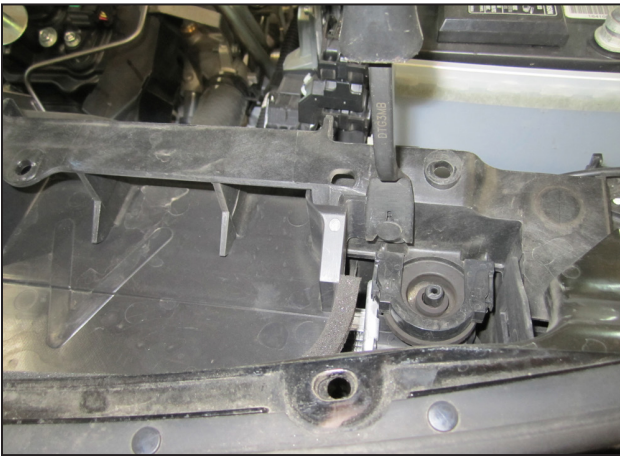

s. Remove the right clip from the lower shroud.



u. Cut and remove the clip from the MAF sensor harness as shown.
NOTE: Use caution and DO NOT cut the MAF sensor wire harness.

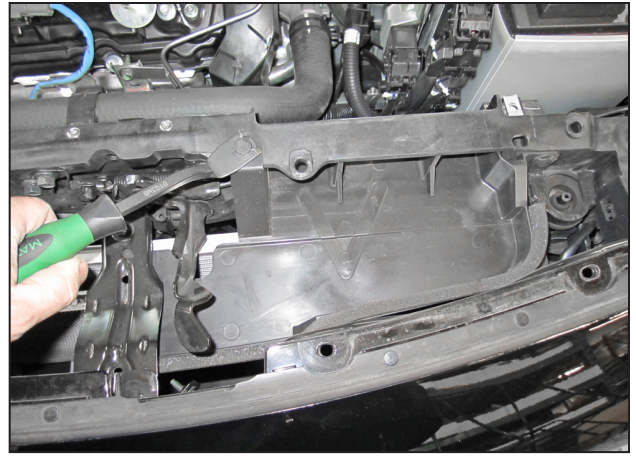

r. Remove the left clip from the lower shroud.

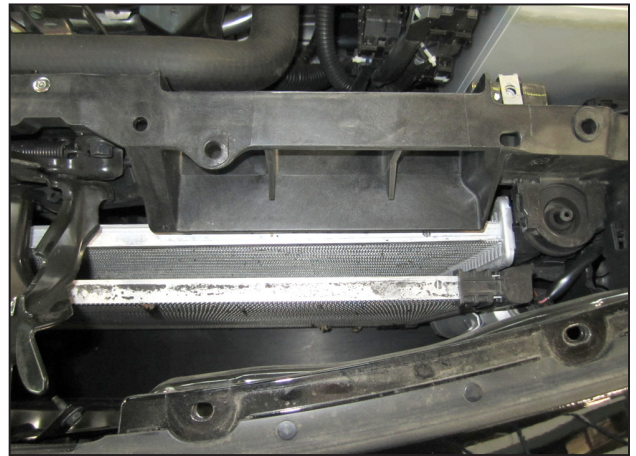

t. Remove the shroud from the vehicle.

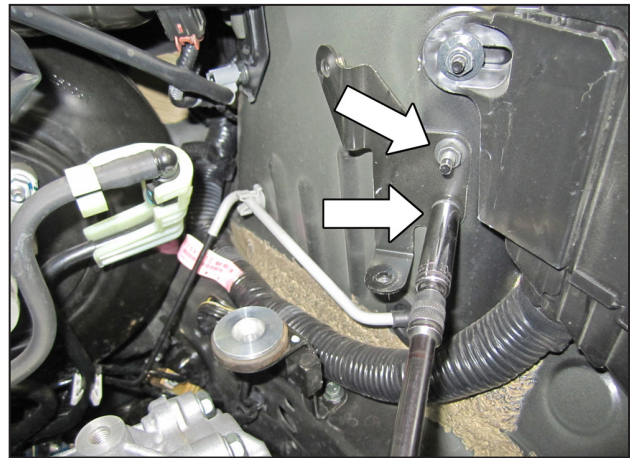

v. Remove the two 10mm bolts securing the factory air box bracket to the inner engine bay wall.

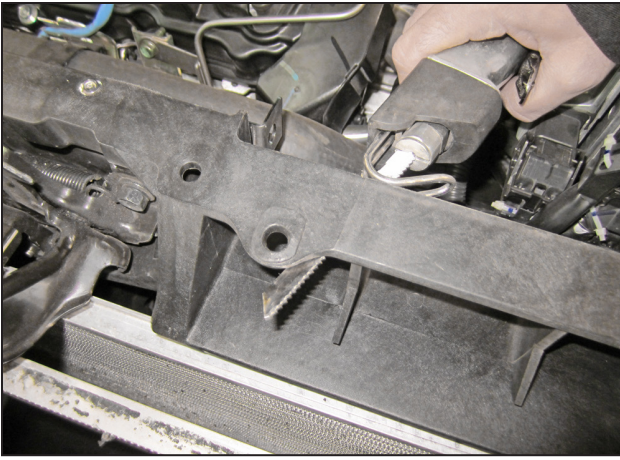

w. Cut the radiator support to make room for the AEM® front scoop.

3. Installation of AEM® Intake System

a. When installing the intake system, do not completely tighten the hose clamps or mounting hardware until instructed to do so.



b. Install coupler (5-325) onto the throttle body and mount two #52 hose clamps as shown.



c. Tighten the #52 hose clamp on the throttle body end.

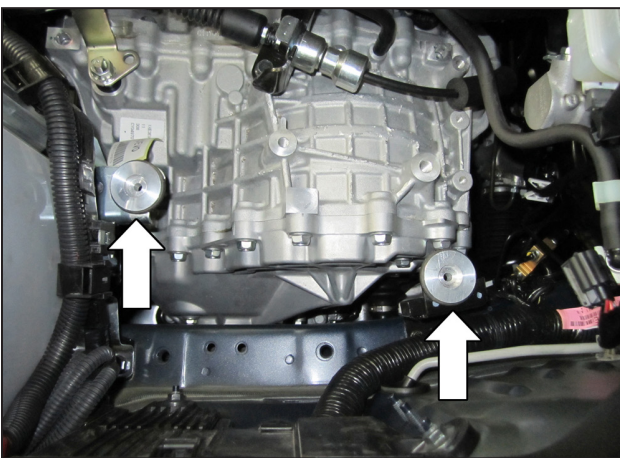

d. Place the two adapters (2-670) onto the factory rubber grommets as shown.

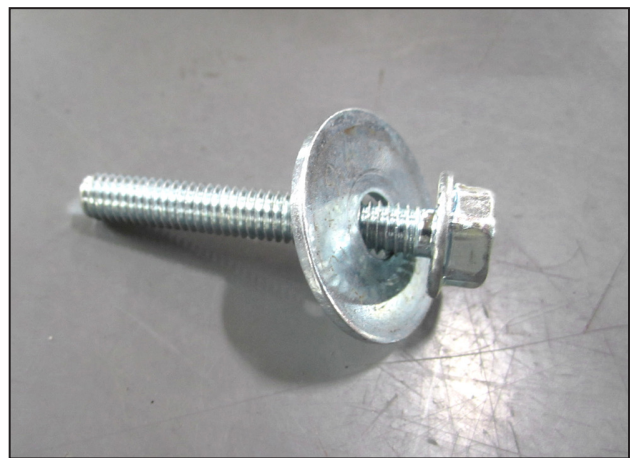

e. Slide a fender washer (08160) onto each of the M6x35mm bolts (1-2002) as shown.

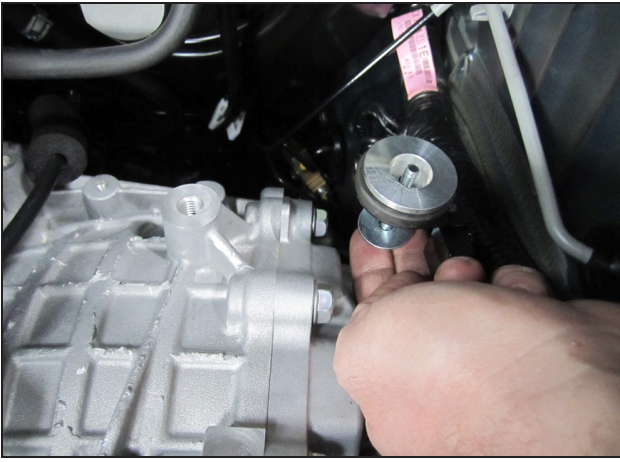

f. From underneath the factory rubber grommets, slide each bolt and fender washer through so the bolt protrudes through the rubber grommet and adapter as shown.

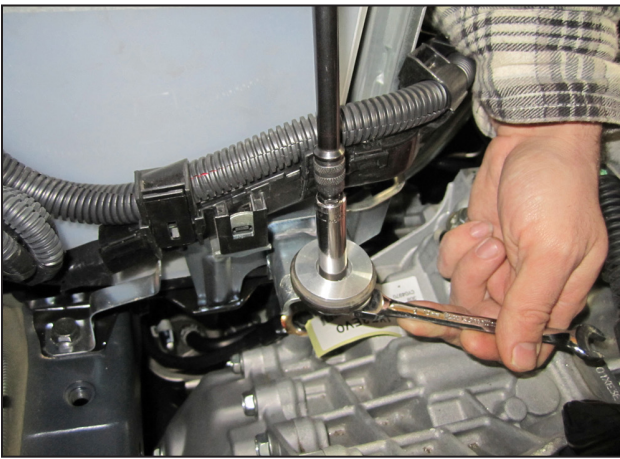

h. Once properly assembled, tighten the nuts and bolts to secure the adapter assemblies.

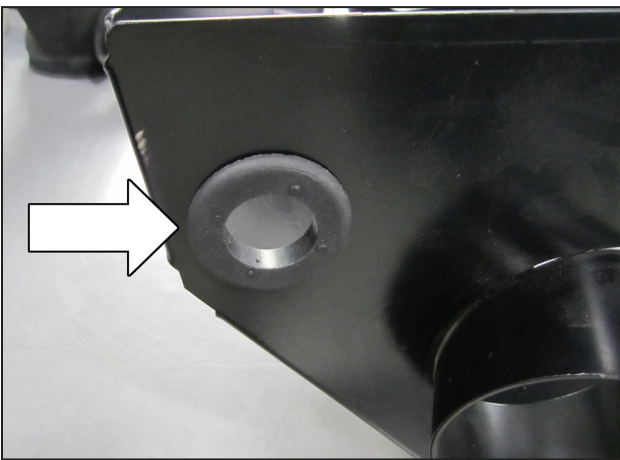

j. Insert the rubber grommet (784640) into the heat shield hole as shown.



g. Use the provided M6 nuts (444.460.04) to keep the assembly together.

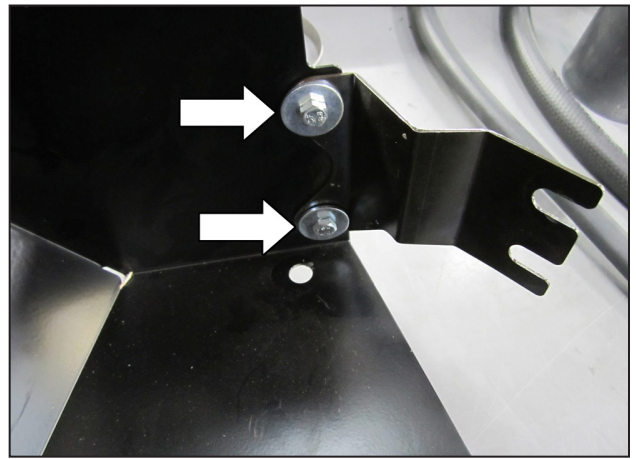

i. Attach the provided bracket (7-7885) onto the heat shield using 2 M6 bolts (1-2065) and 2 washers (08160).



k. Install the rubber edge trim (8-4030) onto the top edge of the heat shield.



l. Install the rubber edge trim around the intake tube opening in the heat shield.

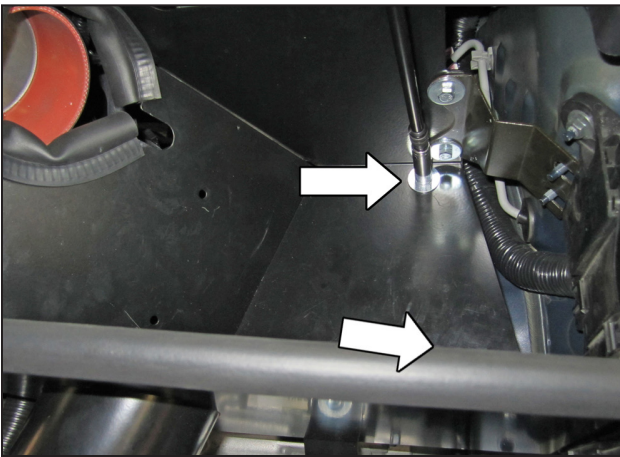

n. Secure the heat shield to the threaded bolt ends with two washers (08160) and two M6 nuts (444.460.04).



p. Once the heat shield is properly positioned, tighten all nuts to secure the heat shield in place.

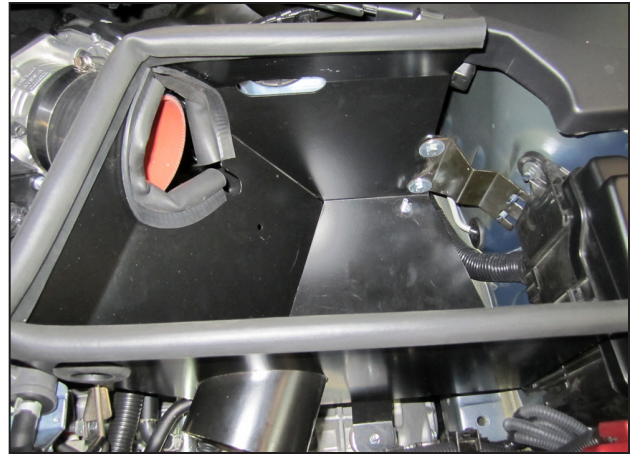

m. Place the heat shield in the vehicle's engine bay, ensuring the threaded ends of the bolts from step 3g align with the openings on the bottom side of the heat shield.

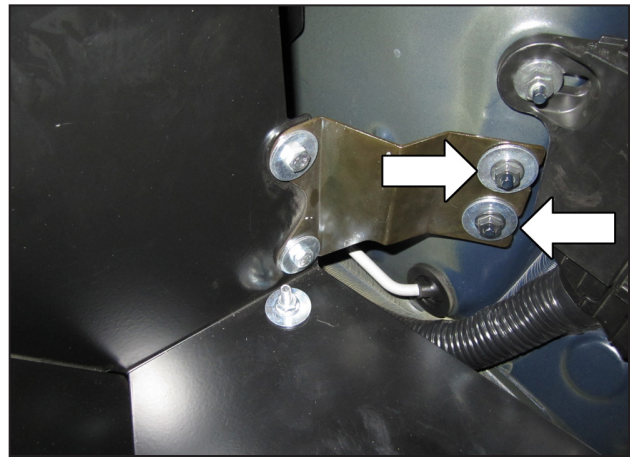

o. Align the heat shield's bracket with the two studs, secure in place using two washers (08160) and the two OEM nuts removed in step 2v.



q. Install the 3.5" coupler (5-351) with two #56 hose clamps onto the heat shields inlet, tighten the hose clamp on the heat shield inlet end.



r. Attach the air inlet hose (5-357) to the air intake tube and loosely secure with a #56 hose clamp.

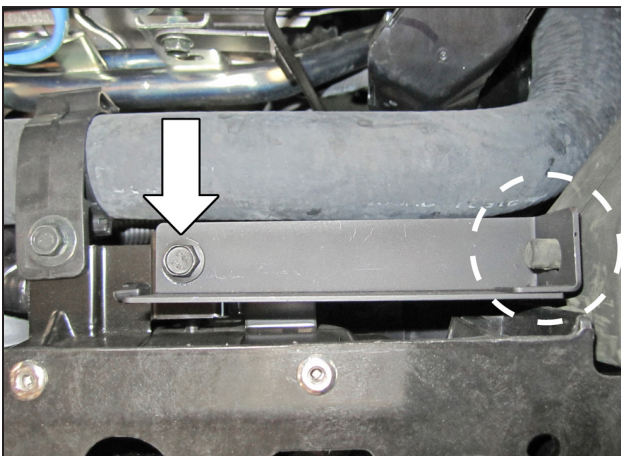

t. Attach bracket (32-3086) to the air inlet hose and to the radiator support using the provided M6 bolt (1-2110).

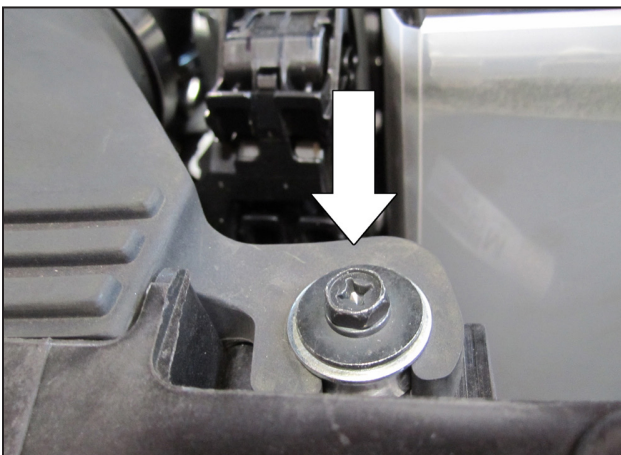

v. Secure the air inlet hose using the OEM bolt and washer (08160) as shown.



s. Install the air inlet hose assembly into the engine bay as shown.

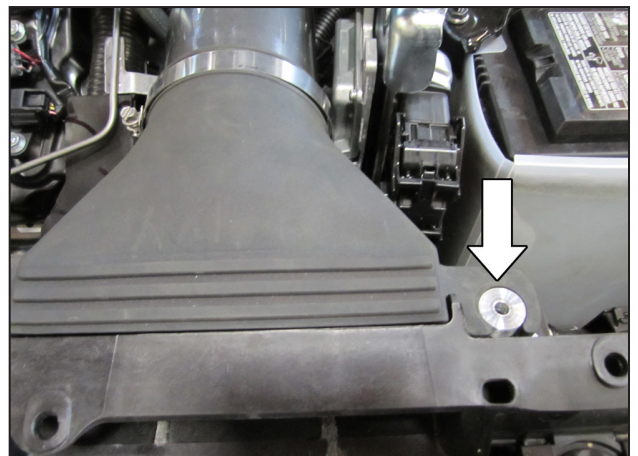

u. Install the mounting block (2-620) onto the air inlet hose as shown.

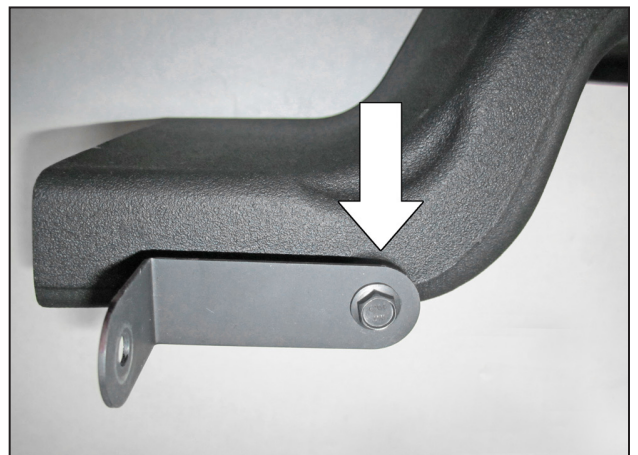

w. Mount the bracket (32-3085) to the air inlet scoop (9-0413) using 1 M6 bolt (1-2110).

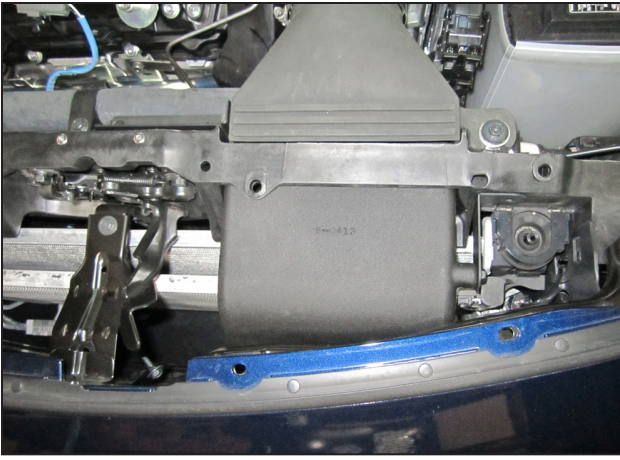

x. Maneuver the air inlet scoop into place as shown.

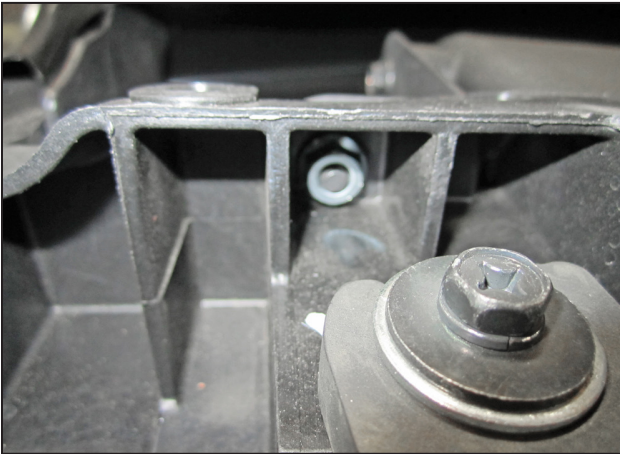

z. Secure the M6 bolt (1-2110) installed in the previous step by attaching 1 M6 nut to the end of the bolt that passed through the radiator support.



ab. Attach the provided vent hose (5-7021) to the PCV port on the valve cover and secure with a hose clamp (08411).

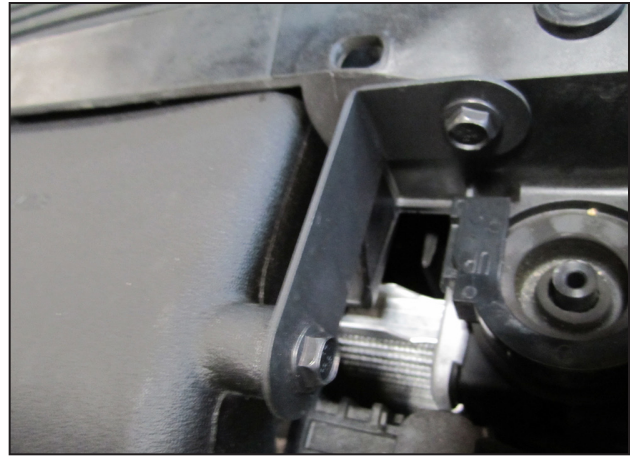

y. Secure the air inlet scoop's bracket to the radiator support using one M6 bolt (1-2110).

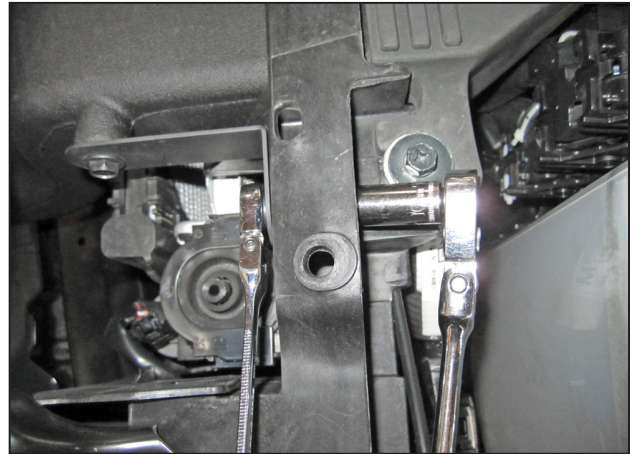

aa. Secure the air inlet scoop's hardware.

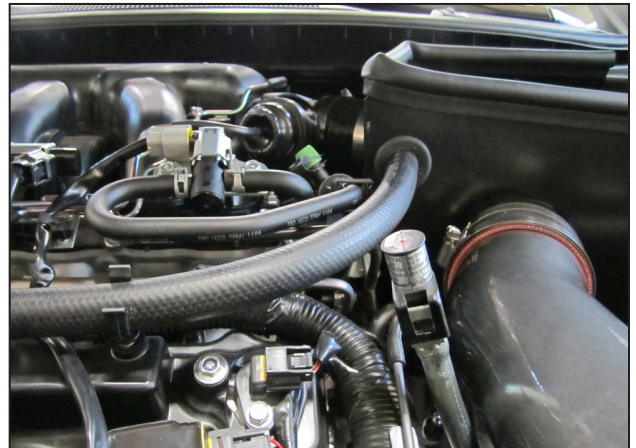

ac. Feed the PCV vent hose through the heat shield hole as shown.

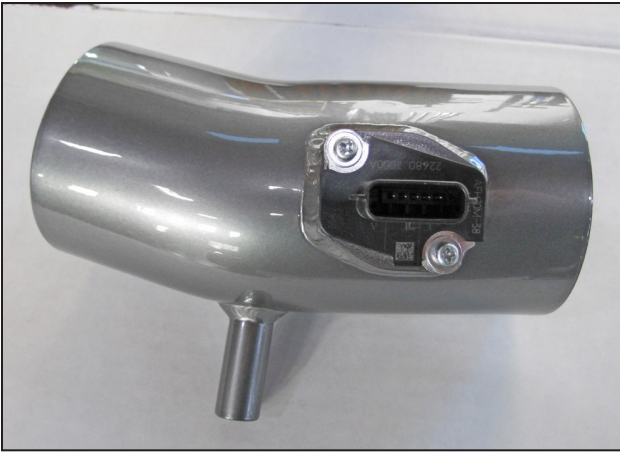

ad. Install the MAF sensor onto the intake tube (2-1481) using the OEM screws.

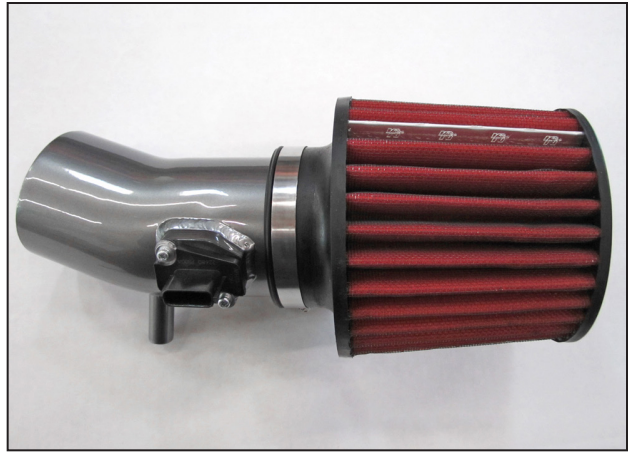

ae. Mount the AEM® air filter onto the intake tube and secure using a #56 hose clamp.



af. Feed the MAF sensor wire harness into the inside area of the heat shield as shown.



ag. Insert the intake pipe assembly into the heat shield as shown.

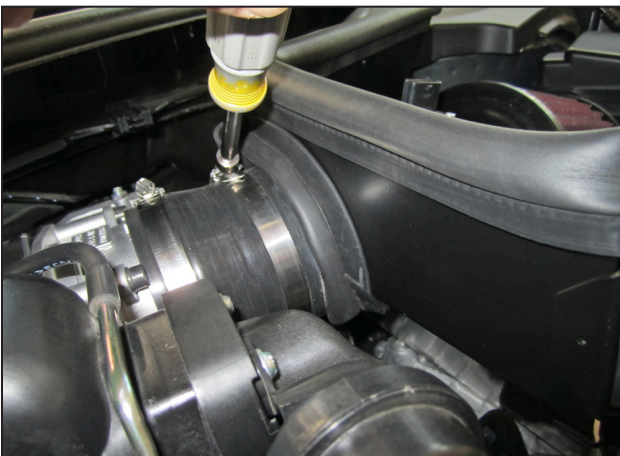

ah. Align the intake pipe with the throttle body's coupler and secure the #52 hose clamp.

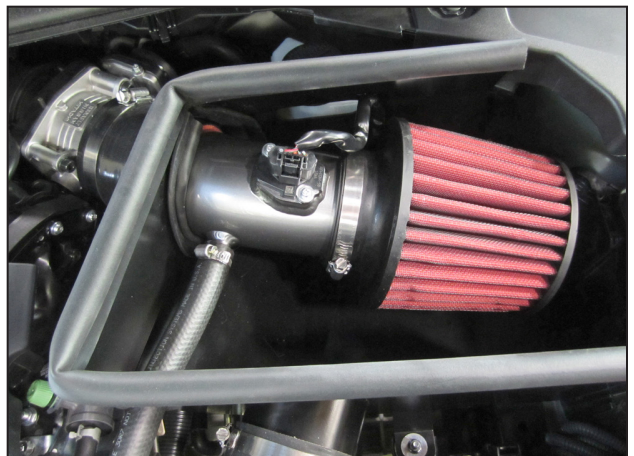

ai. Attach the PCV vent hose to the intake pipe's vent. Secure the vent hose with hose clamp (08411) and connect the MAF sensor harness plug to the MAF sensor.

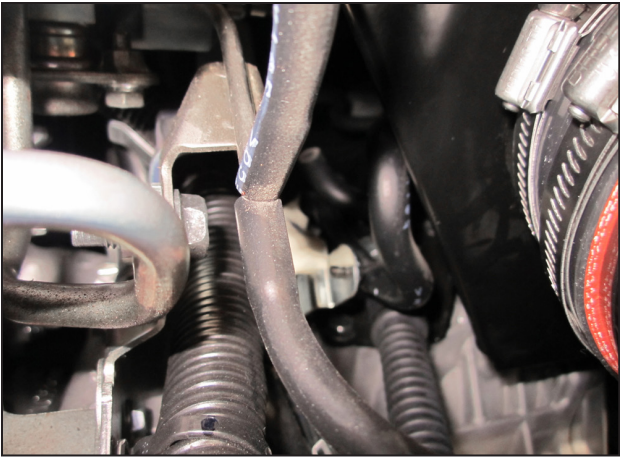

aj. Attach the transmission breather hose's clip to the heat shield from the underside.

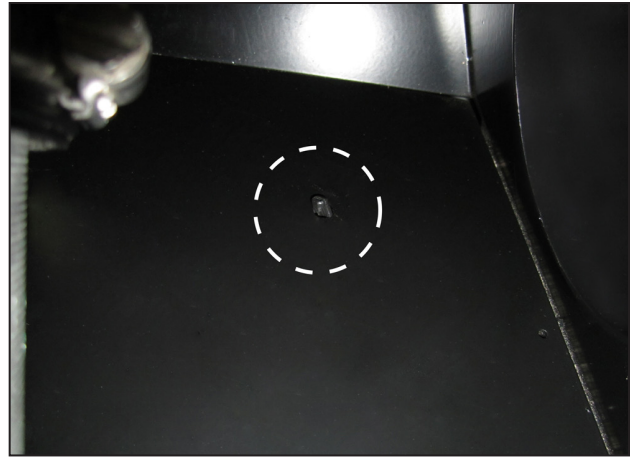

ak. Once the transmission breather hose clip is properly secured to the heat shield hole, it should look like this.

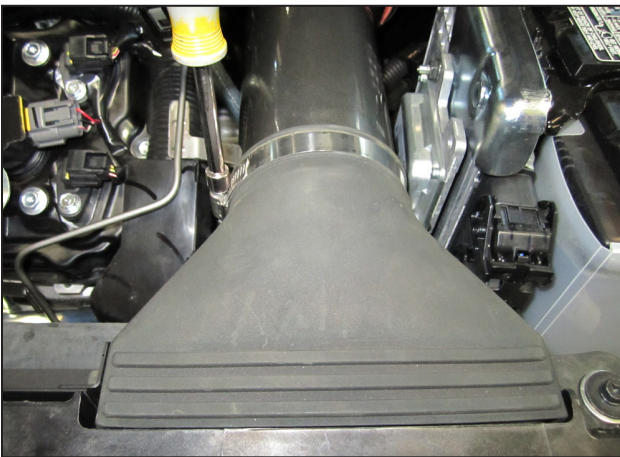

al. Tighten the hose clamp securing the air inlet hose to the air intake tube.



am. Tighten the hose clamp securing the air intake tube to the heat shield inlet.



an. Reinstall the radiator shroud.

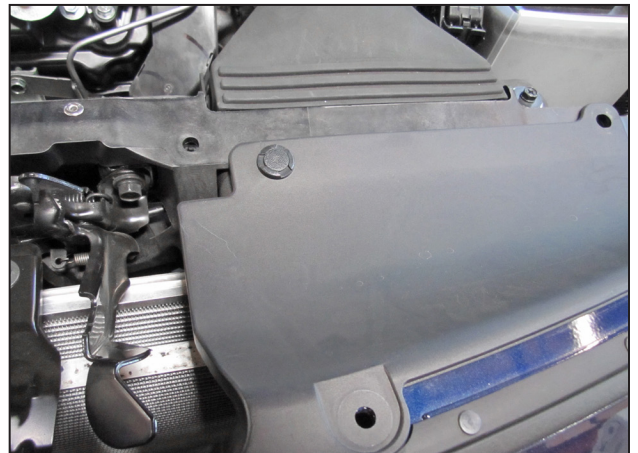

ao. Install the 8 clips to secure the radiator shroud, beginning with the clip securing the air inlet scoop in place.



ap. Reinstall the front grill and engine cover.
Ensure all hardware and hose clamps are secure.

4. Reassemble Vehicle

- a. Position the inlet pipes for the best fitment. Be sure that the pipes or any other components do not contact any part of the vehicle. Tighten any rubber mounts, bolts, and hose clamps.
- b. Check for proper hood clearance. Re-adjust pipes if necessary and re-tighten them.
- c. Inspect the engine bay for any loose tools and check that all fasteners that were moved or removed are properly tightened.
- d. Reconnect the negative battery terminal and start the engine. Let the vehicle idle for 3 minutes. Perform a final inspection before driving the vehicle.

5. CARB Sticker Placement

- a. The C.A.R.B. exemption sticker, (attached), must be visible under the hood so that an emissions inspector can see it when the vehicle is required to be tested for emissions. California requires testing every two years, other states may vary.

6. Service and Maintenance

- a. AEM Induction Systems requires cleaning the intake system's air filter element every 100,000 miles. When used in dusty or off-road environments, our filters will require cleaning more often. We recommend that you visually inspect your filter once every 25,000 miles to determine if the screen is still visible. When the screen is no longer visible some place on the filter element, it is time to clean it. To clean, purchase our Synthetic air filter cleaner, part number 99-0624 and follow the easy instructions.
- b. Use window cleaner to clean your powder coated AEM® intake tube.

NOTE: DO NOT USE aluminum polish on powder coated AEM® intake tubes.

For technical inquiries
e-mail us at
sales@aemintakes.com
or
call us at
800.992.3000

AEM Air Intake System Warranty Policy

AEM® warrants that its intake systems will last for the life of your vehicle. AEM will not honor this warranty due to mechanical damage (i.e. improper installation or fitment), damage from misuse, accidents or flying debris. AEM will not warrant its powder coating if the finish has been cleaned with a hydrocarbon-based solvent. The powder coating should only be cleaned with a mild soap and water solution. Proof of purchase of both the vehicle and AEM intake system is required for redemption of a warranty claim.

This warranty is limited to the repair or replacement of the AEM part. In no event shall this warranty exceed the original purchase price of the AEM part nor shall AEM be responsible for special, incidental or consequential damages or cost incurred due to the failure of this product. Warranty claims to AEM must be transportation prepaid and accompanied with dated proof of purchase. This warranty applies only to the original purchaser of product and is nontransferable. Improper use or installation, use for racing, accident, abuse, unauthorized repairs or alterations voids this warranty. AEM disclaims any liability for consequential damages due to breach of any written or implied warranty on all products manufactured by AEM. Warranty returns will only be accepted by AEM when accompanied by a valid Return Merchandise Authorization (RMA) number. Credit for defective products will be issued pending inspection. Product must be received by AEM within 30 days of the date RMA is issued.

If you have a warranty issue, please call (800) 992-3000 and our customer service department will assist you. A proof of purchase is required for all AEM warranty claims.