



Equipped with AEM® Dryflow™ Filter  
No Oil Required!

# INSTALLATION INSTRUCTIONS

## PART NUMBER

### 21-744C (Gun Metal Gray Finish)

---

2011-14	CHEVROLET	CRUZE	1.4L L4 Turbo	C.A.R.B. E.O.# D-670-22
2015-16	CHEVROLET	CRUZE	1.4L L4 Turbo	

Some intake systems are not legal for sale or use on any pollution controlled motor vehicle in California or states adopting CA emission procedures. To know if a part number is legal in CA on your vehicle, visit [AEMIntakes.com](http://AEMIntakes.com).

ITEM NO.	PART NUMBER	DESCRIPTION	QTY.
1	21-202DK	AIR FILTER; 2.75" X 5" DRYFLOW	1
2	9448	1/2" BNDHOSE CLAMP,2.56"-3.50"	1
3	20-8540	HEAT SHIELD; 2014 CHEVROLET CRUZE TB/PC	1
4	RHBA-M10X125X25	BOLT; M10 X 1.25 X 25MM,BRITE	1
5	RHWA-M10	WASHER, FST, M10	1
6	RHNA-M10X125	NUT; M10X1.25 BRITE ZINC	1
7	102486	EDGE TRIM, 3/4" TOP LOC., 44"L	1
8	102506	EDGE TRIM; 3/4", TOP LOC, 12"L	1
9	8-4017	EDGE TRIM, 17"	1
10	2-1518	TUBE; 2.75"OD X 16"L, (PC), 21-744	1
11	1-2109	BOLT; SOCKET M4-0.7 X 10MM	2
12	08278	WASHER; 4MM FLAT	2
13	9444	HOSE CLAMP, 2.31-3.25"	1
14	5-227	HOSE, ADAPTER 2.25/2.75"X3" BLK	1
15	9436	1/2' BNDHOSE CLAMP,1.81"-2.75"	1

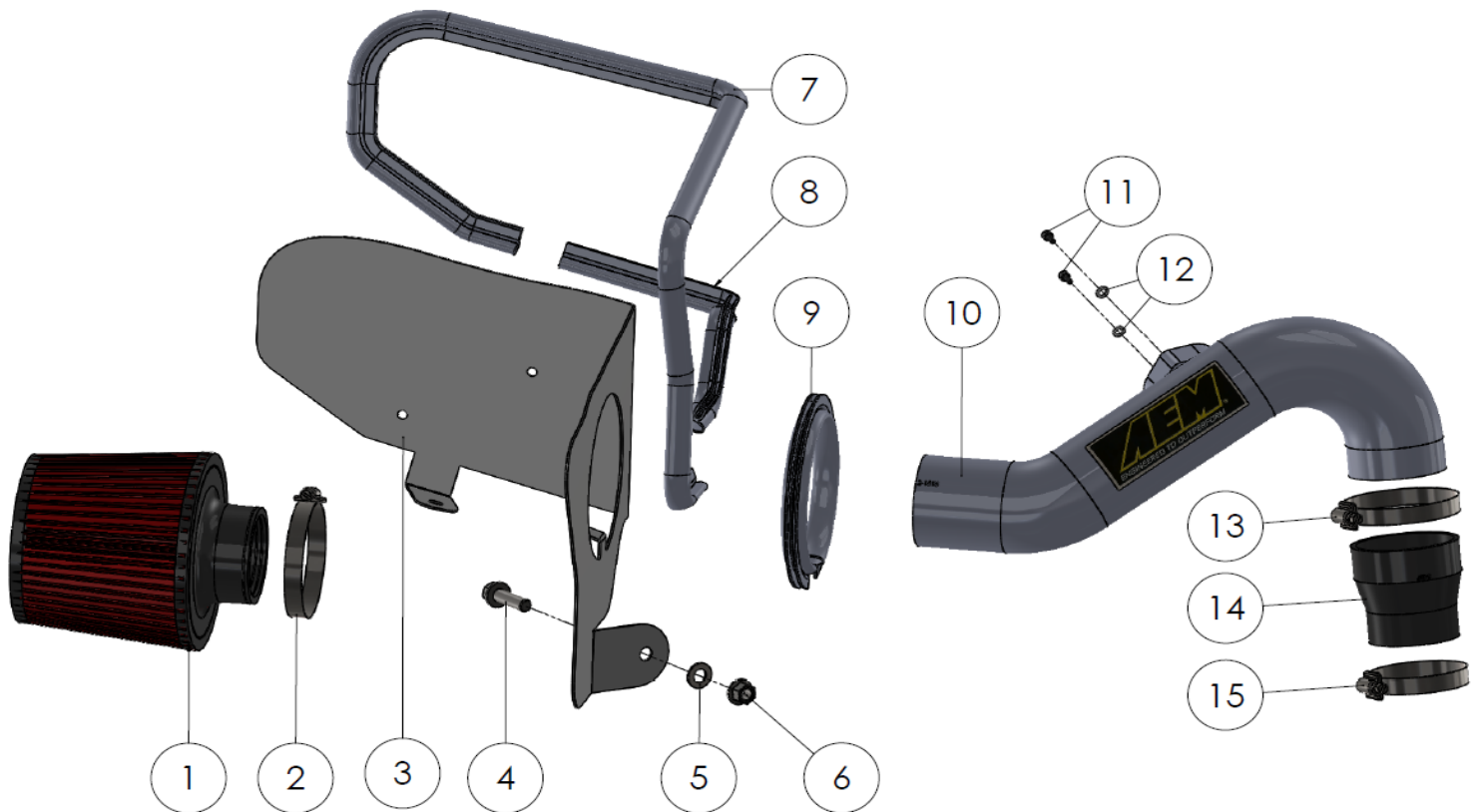

Read and understand these instructions **BEFORE** attempting to install this product. Failure to follow installation instructions and not using the provided hardware may damage the intake tube, throttle body and engine.

**Tools Needed:**

Phillips screw driver  
M6 , M10 sockets  
Ratchet  
M6 nut driver  
M4 hex key

**1. Preparing Vehicle**

- a. Make sure vehicle is parked on level surface.
- b. Set the parking brake.
- c. If engine has run in the past two hours, let it cool down.
- d. Disconnect negative battery terminal.
- e. Do not discard stock components after removal of the factory system.
- f. Open the air intake kit package and make sure all parts are included.

**2. Removal of stock system**

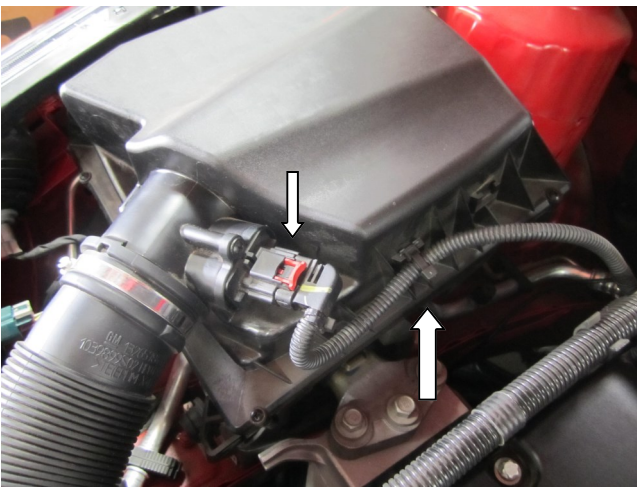

a. Release the red tab on the mass air sensor connector and disconnect the connector. Then slide the wire harness clip out of the air box.



b. Loosen the hose clamp at the turbo compressor.



c. Pull the air box up and out of the vehicle. Note: Do not discard any of your stock equipment.

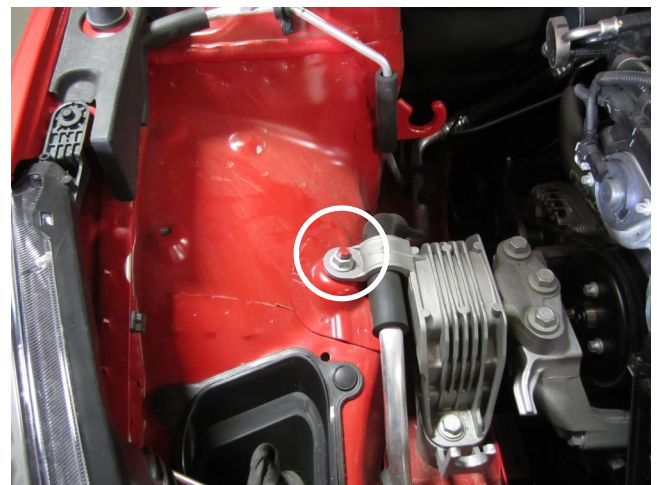

d. Remove the nut (circled) on the engine mount. This nut will be reinstalled in Step 3e.



e. Remove the two screws securing the mass air sensor to the air box. Note: The screws will not be reused. The sensor will be reused in step 3h.

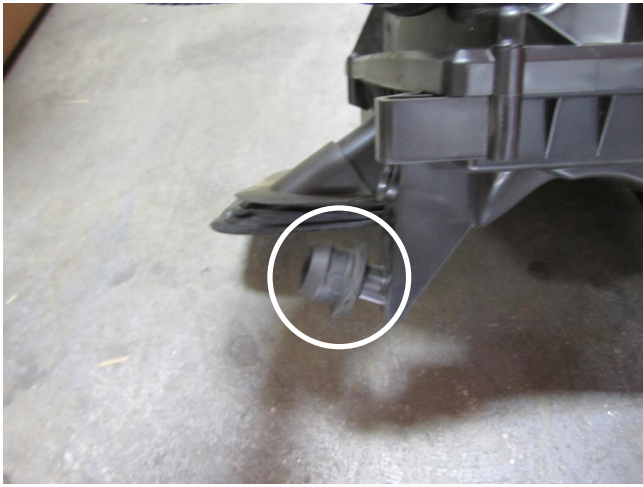

f. Remove the rubber grommet from the stock air box. This will be reused in step 3b.

**3. Installation of AEM® intake system.**

a. When installing the intake system, do not completely tighten the hose clamps or mounting hardware until instructed to do so.



a. Install all 3 pieces of edge trim onto the heat shield as shown..



b. Install the rubber grommet that was removed in step 2f. into the mount location as shown.

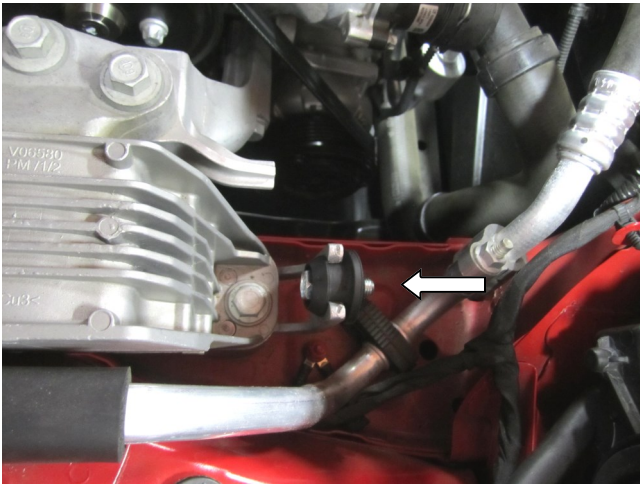

c. Install the supplied M10 bolt into the rubber mount.

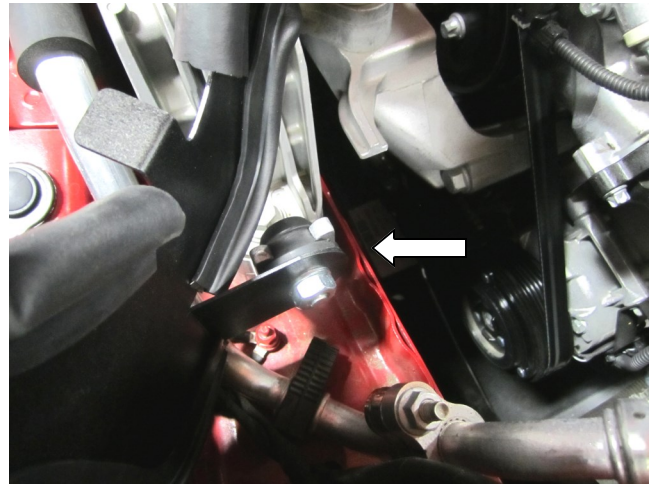

d. Install the heat shield by aligning the tab with the previously installed bolt, then secure it with supplied washer and M10 nut. Note: Tighten until the threads start to protrude out of the nut.

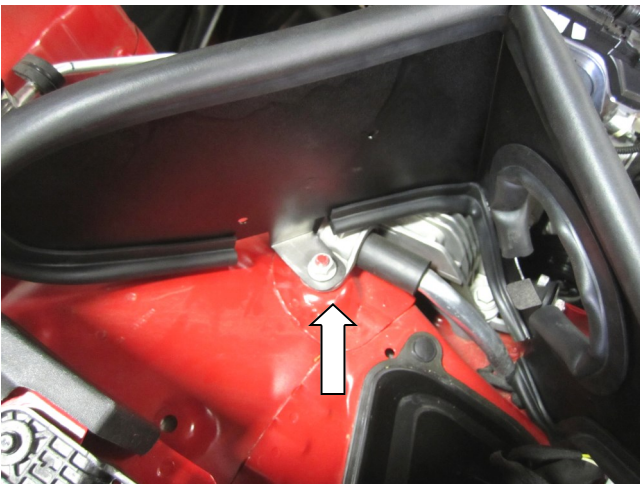

e. Align the other heat shield tab with the engine stud mount. Install and tighten the nut that was previously removed in step 2d.



f. Install the coupler and two clamps onto the turbo air inlet. Do not tighten at this time.



g. Install the filter into the heat shield. Note: The filter flange will rest on top of the heat shield tab and the clamp will go around the flange and the tab.



h. Install the mass air sensor that was removed in step 2e. into the AEM intake tube and secure with the supplied hardware.



i. Install the AEM intake tube into the filter. Note: Do not fully tighten clamp at this time.



j. Install the other end of the AEM intake tube into the coupler.



k. Once proper alignment is achieved, tighten all of the hose clamps at the filter and the turbo air inlet.



l. Reconnect the harness to the sensor that was removed in step 2a.



STOCK INTAKE INSTALLED



AEM INTAKE INSTALLED

#### 4. Reassemble Vehicle

- a. Position the inlet pipes for the best fitment. Be sure that the pipes or any other components do not contact any part of the vehicle.
- b. Check for proper hood clearance. Re-adjust pipes if necessary and re-tighten them.
- c. Inspect the engine bay for any loose tools and check that all fasteners that were moved or removed are properly tightened.
- d. Reconnect negative battery terminal and start engine. Let the vehicle idle for 3 minutes. Perform a final inspection before driving the vehicle.

#### 5. Service and Maintenance

- a. AEM Induction Systems requires cleaning the intake system's air filter element every 100,000 miles. When used in dusty or off-road environments, our filters will require cleaning more often. We recommend that you visually inspect your filter once every 25,000 miles to determine if the screen is still visible. When the screen is no longer visible some place on the filter element, it is time to clean it. To clean, purchase our Synthetic air filter cleaner, part number 1-1000 and follow the easy instructions.
- b. Use window cleaner to clean your powder coated AEM<sup>®</sup> intake tube.

**NOTE: DO NOT USE aluminum polish on powder coated AEM<sup>®</sup> intake tubes.**

For technical inquiries  
e-mail us at  
[sales@aemintakes.com](mailto:sales@aemintakes.com)  
or  
call us at  
800.992.3000

## **AEM Air Intake System Warranty Policy**

AEM® warrants that its intake systems will last for the life of your vehicle. AEM® will not honor this warranty due to mechanical damage (i.e. improper installation or fitment), damage from misuse, accidents or flying debris. AEM® will not warrant its powder coating if the finish has been cleaned with a hydrocarbon-based solvent. The powder coating should only be cleaned with a mild soap and water solution. Proof of purchase of both the vehicle and AEM® intake system is required for redemption of a warranty claim.

This warranty is limited to the repair or replacement of the AEM® part. In no event shall this warranty exceed the original purchase price of the AEM® part nor shall AEM® be responsible for special, incidental or consequential damages or cost incurred due to the failure of this product. Warranty claims to AEM® must be transportation prepaid and accompanied with dated proof of purchase. This warranty applies only to the original purchaser of product and is nontransferable. Improper use or installation, use for racing, accident, abuse, unauthorized repairs or alterations voids this warranty. AEM® disclaims any liability for consequential damages due to breach of any written or implied warranty on all products manufactured by AEM®. Warranty returns will only be accepted by AEM® when accompanied by a valid Return Merchandise Authorization (RMA) number. Credit for defective products will be issued pending inspection. Product must be received by AEM® within 30 days of the date RMA is issued.

If you have a warranty issue, please call (800) 992-3000 and our customer service department will assist you. A proof of purchase is required for all AEM® warranty claims.

**Some intake systems are not legal for sale or use on any pollution controlled motor vehicle in California or states adopting CA emission procedures. To know if a part number is legal in CA on your vehicle, visit [AEMIntakes.com](http://AEMIntakes.com).**