



Equipped with AEM® Dryflow™ Filter
No Oil Required!

INSTALLATION INSTRUCTIONS

PART NUMBER: 24-6001

1992-1995 HONDA Civic SI	L4-1.6L		C.A.R.B. E.O. # D-670
1992-1995 HONDA Civic LX	L4-1.5L	Manual Trans.	C.A.R.B. E.O. # D-670
1994-1995 HONDA Civic EX	L4-1.6L	Manual Trans.	C.A.R.B. E.O. # D-670
1992-1995 HONDA Civic DX Hatchback	L4-1.5L	Manual Trans.	C.A.R.B. E.O. # D-670
1992-1995 HONDA Civic DX	L4-1.5L	Manual Trans.	C.A.R.B. E.O. # D-670
1992-1993 HONDA Civic	L4-1.6L	Manual Trans.	C.A.R.B. E.O. # D-670

* **NOTE:** Legal in California only for racing vehicles which may never be used upon a highway

PARTS LIST

Description	Qty.	Part Number
Air Filter Assy. 3.50 X 5" Dry Ele.	1	21-204DK
Inlet Pipe	1	2-60011
Bracket, Trans D16	1	32-3021
Hose, Silicone 2.50x3" Blk.	1	5-250
Hose; 5/16ID X 11"L	1	5-2011
Mount, Rubber 1" X 6mm	1	1228599
Hose; 3/8"ID X 10"L	1	5-1010
Bolt, Hex/Flange M12-1.25 X 25	3	1-2076
Washer, M12 SAE Flat	1	1-3029
Washer, 6mm Soft Mount	1	559999
Nut, M12-1.25 X 25 Nylock	1	1-2077
Nut, M6 Hex Serrated	1	444.460.04
1/2" Bnd. Hose Clamp, 2.15-3.00"	2	9440
Hose Clamp, 3/4"	2	4093-5
Hose Clamp, 1"	2	99024.032
1/2" Bnd. Hose Clamp,3.15"-4.00"	1	9456

Read and understand these instructions **BEFORE** attempting to install this product. Failure to follow installation instructions and not using the provided hardware may damage the intake tube, throttle body and engine.

1. Preparing Vehicle

- a. Make sure vehicle is parked on level surface.
- b. Set parking brake.
- c. If engine has run in the past two hours, let it cool down.
- d. Disconnect all negative battery terminals.
- e. Raise the front of the vehicle with a jack. Refer to your owner's manual for proper jack and jack stand placement to properly support vehicle. Support your vehicle using properly rated jack stands before wheel removal or while working under the vehicle.

NEVER WORK UNDER A VEHICLE WITHOUT USING JACK STANDS.

- f. Remove the front right wheel.
- g. Do not discard stock components after removal of the factory system.

2. Removal of stock system



a. Remove the water hose on the left of injector #4 by loosening the hose clamp and sliding the water hose upward. Be prepared to catch any coolant that spills out with a rag.

NOTE: Ensure the engine is completely cool before removing the coolant hose, or hot coolant will escape from the cooling system and cause injury or damage.

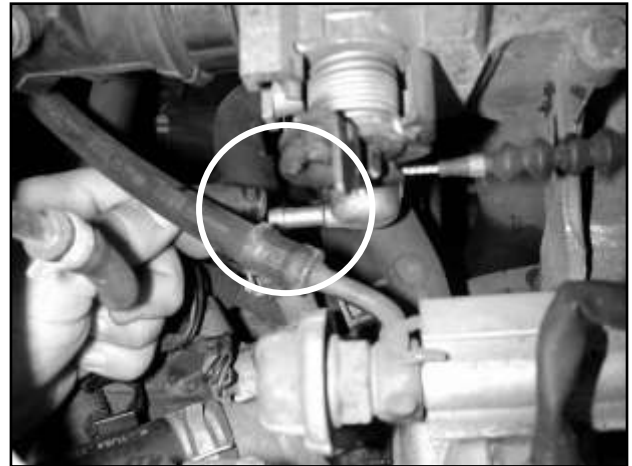

b. Remove the other end of the water hose from the fitting underneath the throttle body.



c. Detach the PCV hose from the fitting on the valve cover. Remove the hose assembly from the car.



d. Loosen the hose clamp on the throttle body.



e. Remove the air intake snorkel by pulling it straight up until it unsnaps.



f. Remove the three air box mounting bolts and remove the factory air intake system from the car.

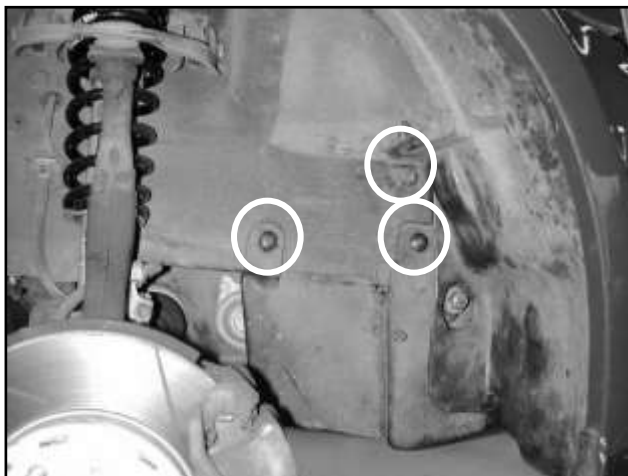

g. After removing the front right wheel, remove the fender liner fasteners shown in the picture.



h. From underneath the car, remove the splash guard fasteners shown in the picture.



i. Tuck the fender liner out of the way behind the brake rotor.

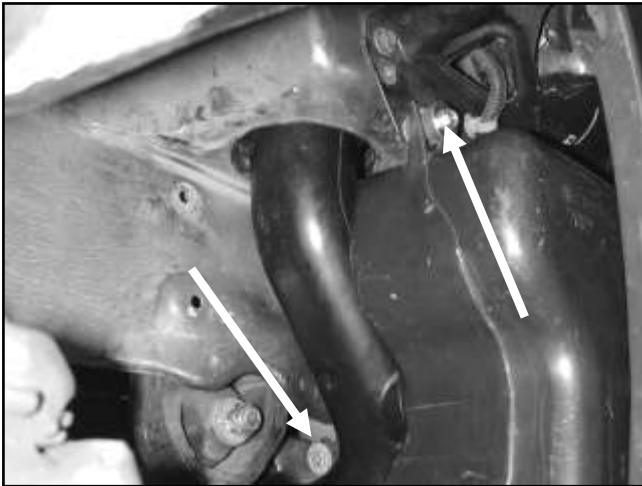

j. Remove the three bolts holding on the air intake resonator assembly and remove it from the vehicle.

3. Transmission mount removal and installation

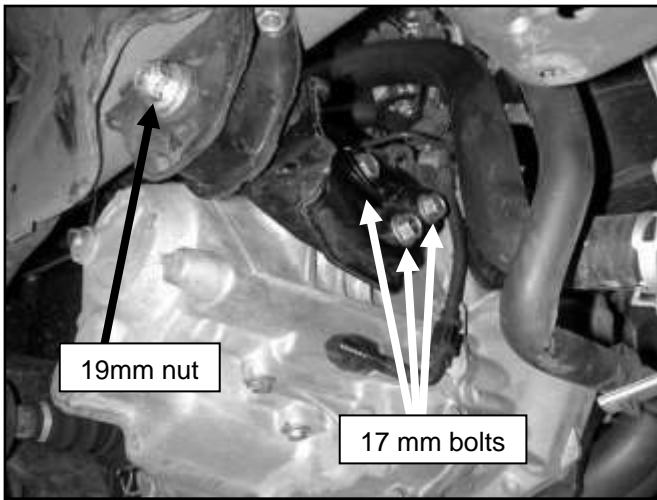

a. Using a 19mm socket, remove the engine mount nut, then loosen the three bolts with a 17mm wrench, and remove the mount.



b. Using a 14 mm wrench, remove the mounting stud from the factory engine mount assembly. It may be necessary hold the bracket in a vice to do this.



c. Install the factory mounting stud from step b on the supplied engine mount bracket, using the nylock nut and washer provided.

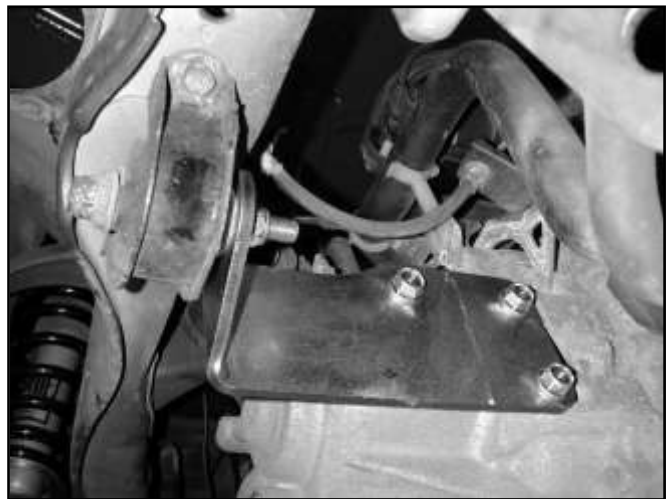

d. Using the supplied bolts, install the AEM[®] engine mount on the transmission; torque the bolts to 61 ft-lb. Then replace the factory washer and nut on the mounting stud.

4. Installation of AEM® intake system.

- a. When installing the intake system, do not completely tighten the hose clamps or mounting hardware until instructed to do so.



b. Install the 5/16" ID hose, and two 3/4" hose clamps, in place of the hose assembly removed in Section 2a & 2b.
NOTE: Replace any coolant recovered during hose removal by replenishing the recovery tank.

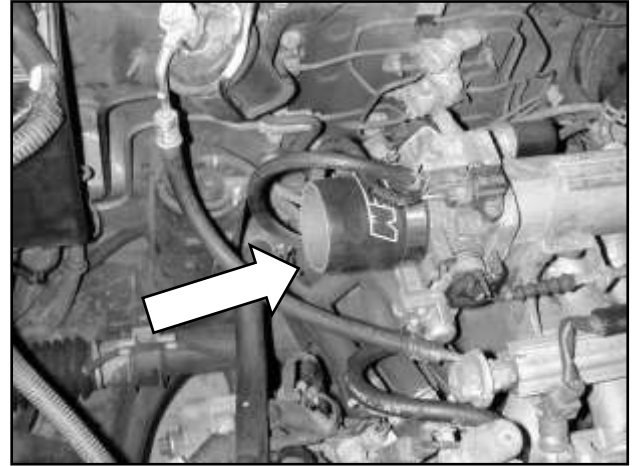

c. Install the AEM® silicone coupler onto the throttle body.



d. Thread the rubber mount into the hole on the bottom of the vehicle. (Hole that is exposed from the intake resonator removal during step 2j).



e. Insert the intake pipe into the engine bay as shown. Position the intake pipe so the 3.5" end is in the area behind the front bumper where the resonator was located.



f. Line up the intake pipe support tab with the rubber mount. Install the rubber mount assembly as shown in the diagram below.
NOTE: DO NOT TIGHTEN THE NUT.

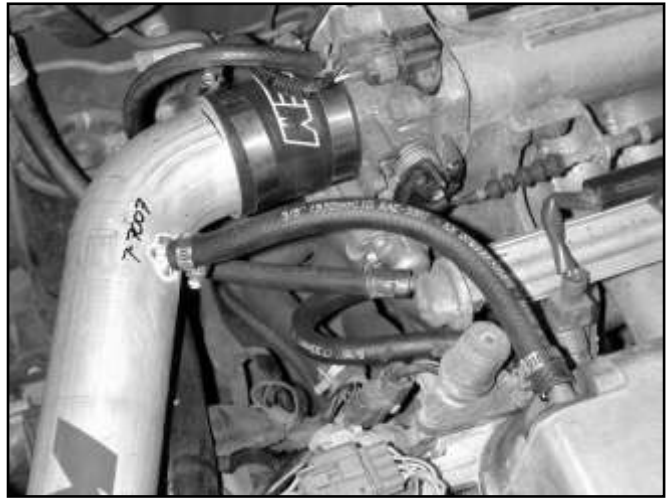

g. Insert the 2.5" end of the pipe into the silicone coupler on the throttle body. Use the #40 hose clamps on the coupler. Install the 3/8" ID hose from the valve cover breather fitting to the nipple on the intake pipe. Use the 1" hose clamps to secure it in place.

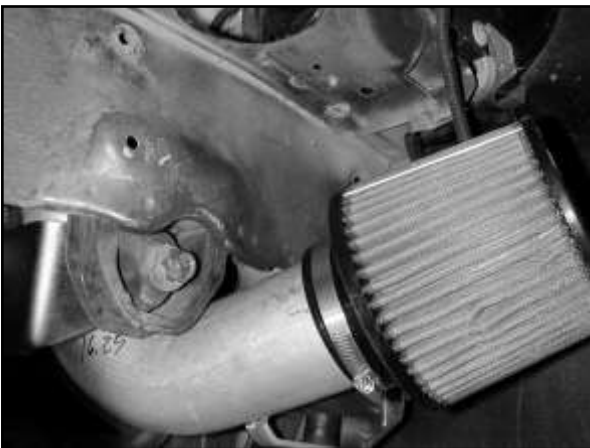
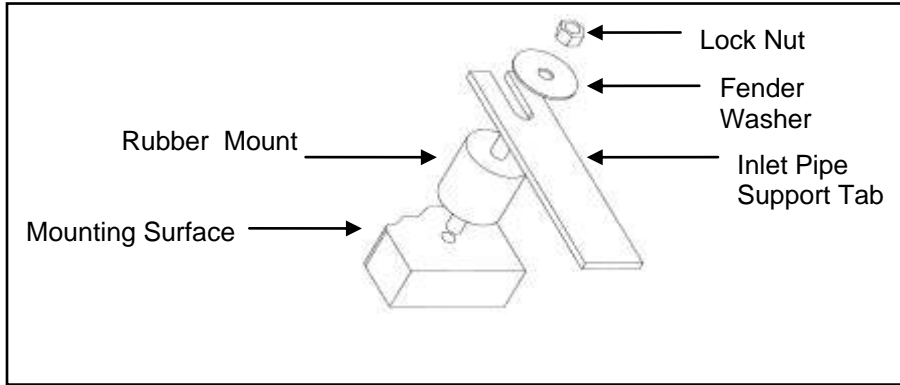

h. Install the air filter on the end of the intake pipe. Make sure the air filter is fully seated on the end of the pipe. Secure it in place with the supplied hose clamp.

4. Reassemble Vehicle

- a. **Fender Liner:** Install the fender liner that was partially removed and secure all splash guard and fender liner fasteners.
- b. **Wheel:** Install the front right wheel using the factory torque specification (see owner's manual).
- c. Position the inlet pipes for the best fitment. Be sure that the pipes or any other components do not contact any part of the vehicle. Tighten the rubber mount, all bolts, and hose clamps.
- d. Check for proper hood clearance. Re-adjust pipes if necessary and re-tighten them.
- e. Inspect the engine bay for any loose tools and check that all fasteners that were moved or removed are properly tightened.
- f. Reconnect negative battery terminals and start engine. Let the vehicle idle for 3 minutes. Perform a final inspection before driving the vehicle.

5. CARB Sticker Placement

- a. The C.A.R.B. exemption sticker, (attached), must be visible under the hood so that an emissions inspector can see it when the vehicle is required to be tested for emissions. California requires testing every two years, other states may vary.

6. Service and Maintenance

- a. It is recommended that you service your AEM® Dryflow™ filter every 20,000 miles for optimum performance. Use AEM Dryflow cleaning kit part # 21-110.
- b. Use aluminum polish to clean your polished AEM intake tube.
- c. Use window cleaner to clean your powder coated AEM intake tube. **(NOTE: DO NOT USE aluminum polish on powder coated AEM intake tubes)**

For technical inquiries
e-mail us at
sales@aemintakes.com
or
call us at
800.992.3000

AEM Air Intake System Warranty Policy

AEM® warrants that its intake systems will last for the life of your vehicle. AEM will not honor this warranty due to mechanical damage (i.e. improper installation or fitment), damage from misuse, accidents or flying debris. AEM will not warrant its powder coating if the finish has been cleaned with a hydrocarbon-based solvent. The powder coating should only be cleaned with a mild soap and water solution. Proof of purchase of both the vehicle and AEM intake system is required for redemption of a warranty claim.

This warranty is limited to the repair or replacement of the AEM part. In no event shall this warranty exceed the original purchase price of the AEM part nor shall AEM be responsible for special, incidental or consequential damages or cost incurred due to the failure of this product. Warranty claims to AEM must be transportation prepaid and accompanied with dated proof of purchase. This warranty applies only to the original purchaser of product and is nontransferable. Improper use or installation, use for racing, accident, abuse, unauthorized repairs or alterations voids this warranty. AEM disclaims any liability for consequential damages due to breach of any written or implied warranty on all products manufactured by AEM. Warranty returns will only be accepted by AEM when accompanied by a valid Return Merchandise Authorization (RMA) number. Credit for defective products will be issued pending inspection. Product must be received by AEM within 30 days of the date RMA is issued.

If you have a warranty issue, please call (800) 992-3000 and our customer service department will assist you. A proof of purchase is required for all AEM warranty claims.