

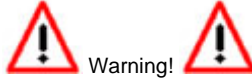

DLG-1

User Manual



Warning!

The Oxygen Sensor used in this device gets very hot in operation. Do not touch a hot sensor. Do not let a hot sensor touch a combustible surface. Do not use the sensor with or near flammable liquids or gases. Failure to heed these warnings may result in severe burns, explosions, fires, or other dangerous events.

1.	DLG-1	2
1.1	Changing the DLG-1's gauge face and/or bezel	2
2	Installation	4
2.1	Wiring	4
2.1.1	Relay Wiring Instructions	6
2.2	DLG-1 Mounting and Routing	6
2.3	LC-2 Mounting	6
2.4	Interfacing the DLG-1 with the LC-2	7
2.5	Wideband Oxygen Sensor Setup	7
2.5.1	Oxygen Sensor Placement	7
2.5.2	Sensor Calibration	8
2.5.3	Calibration Schedule	9
3	DLG-1 Configuration	10
3.1	Entering Setup Configuration	10
3.1.1	Configuration using DLG-1's interface buttons	10
3.1.2	Configuration using the LM Programmer software	10
3.2	Display Settings (Gauge Abbreviations)	11
4	Logworks 3 & LM Programmer Software Package	11
4.1	Download and Install the Logworks 3 Software	11
4.2	LM Programmer	11
4.2.1	Programming Analog Output	12
4.2.2	Advanced Analog Output Programming	12
4.2.3	Updating the Firmware	13
4.2.4	Changing Sensor Type	13
	Appendix A: Limited Warranty	15
	Appendix B: DLG-1 Error Codes and Troubleshooting Tips	16

1. DLG-1

The DLG-1 is a dual channel A/F display gauge with one integrated wideband AFR (lambda) channel. Using the MTS digital input, the DLG-1 can display the A/F channel of any one of Innovate Motorsports' line of wideband controllers. The gauge also has one configurable analog output for integration with aftermarket ECU's and 3rd party data loggers. The following section will help you get familiar with the DLG-1.

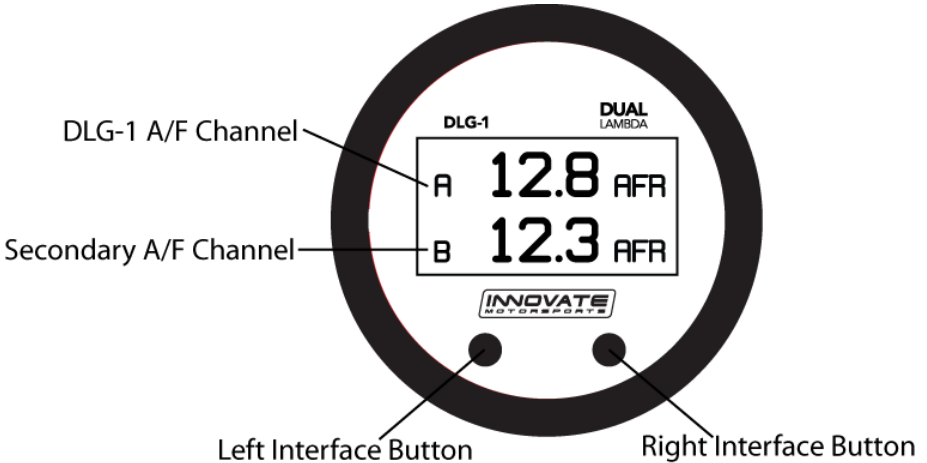

1. Channel Displays

- The DLG-1 has three different displays modes that can be cycled through on the main screen with the left and right interface buttons. It can be configured to display both A/F channels in equal focus or either one of the two A/F channels in greater focus than the other.

2. Interface Buttons

- Pressing either the left or right interface buttons will allow you to cycle through the 3 different display modes.
- From the main screen, pressing and HOLDING the left interface button will put the gauge in setup mode. Once in setup mode, pressing and HOLDING both interface buttons together will move you to the menu or main screen. The gauge will revert back to the main screen if no there have been no button presses for 15 seconds.
- While on the main screen, press and HOLD both interface buttons to sync the second A/F channel connected to the serial IN port.

1.1 Changing the DLG-1's gauge face and/or bezel

1. Lay the DLG-1 face down and remove the three #2 phillips screws from the outside rim of the back plate.

2.

Pull the bezel (black ring) upwards to remove.

Thumb must be pressing down on the glass

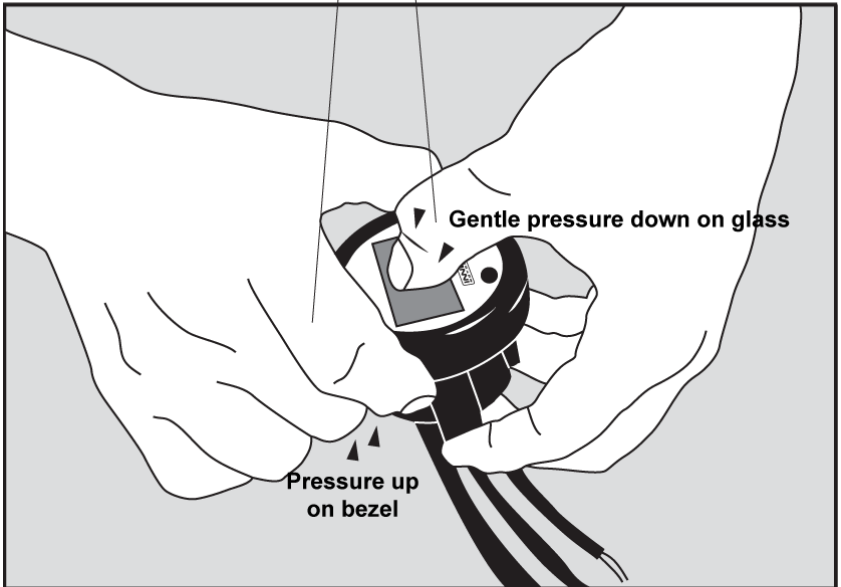

* When disassembling, be careful not to lose the clear plastic light pipe from the shift light opening as it can fall out.

** Pulling the bezel upwards while NOT holding the glass down can potentially damage the gauge.

3. Configure the gauge as desired by changing the gauge face and/or bezel.
4. Make sure every piece is positioned correctly using the locating tab and reassemble the gauge.
5. Reinstall the three #2 phillips screws verifying that the buttons are not binding on the gauge lens.

2 Installation

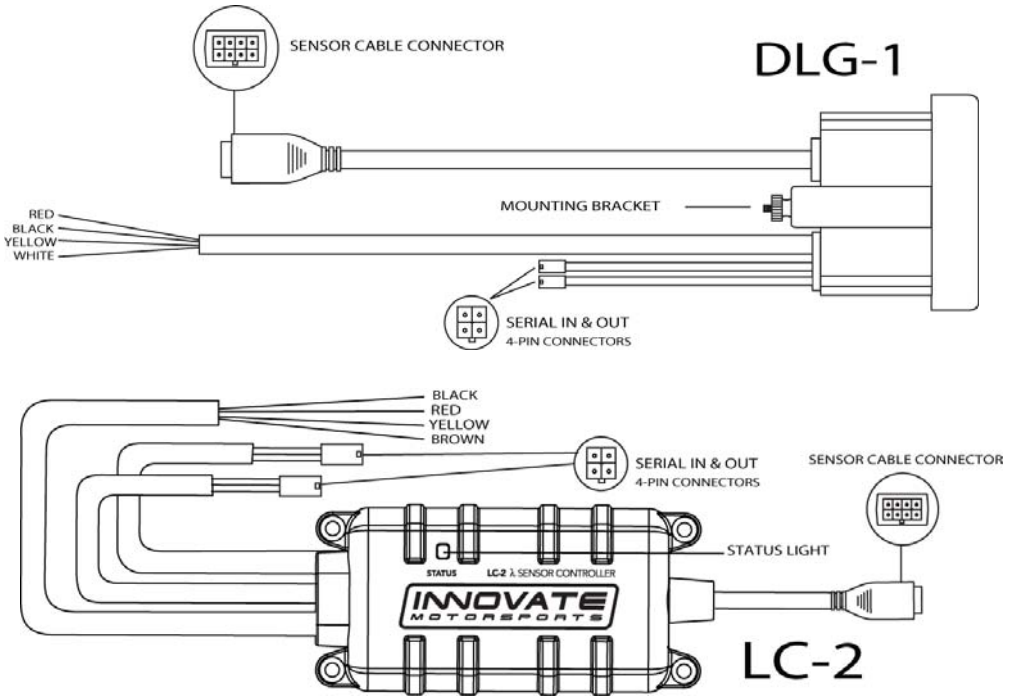

2.1 Wiring

- 1 On both the **DLG-1** and **LC-2**, connect the **RED** wire to an isolated switched 12V source in your vehicle. A switched 12V source goes ON as soon as “key on” power is active. The circuit to which you will pull power from should be able to support a 6 amp draw (3 amps each from the DLG-1 and LC-2.) Make sure each connection is protected with a 5A fuse (not supplied.)



Circuits that share power with the vehicle’s stereo, ignition system, ECU, lighting, or fuel pump should not be used. When in doubt, create an additional circuit using an automotive relay available at any automotive parts supplier. See the next section for a relay installation diagram.

- 2 On both the **DLG-1** and **LC-2**, the **BLACK** wire should be grounded to a solid ground source. The best possible ground source would be the battery ground (-) post.



If other Innovate Motorsports devices are going to be daisy-chained along with the DLG-1, it is recommended that all devices be connected to a single ground point, ideally the battery ground (-) post.

- 3 Connect the **WHITE** wire of the **DLG-1** to a headlight power wire (a wire that goes hot with 12V when the headlights are on). This enables the display to dim for better nighttime viewing. **DO NOT CONNECT THIS WIRE TO THE HEADLIGHT DIMMING WIRE.** Connection to this rheostat type of switch will cause the gauge to malfunction. If you chose not to utilize the dimming feature, connect the **WHITE** wire to ground.

- 4 Optionally, the **YELLOW** analog output from the **DLG-1** and/or **LC-2** can be connected to the analog inputs of other devices such as data loggers or aftermarket programmable ECUs. Only **ONE** analog output from either device can be connected to one analog input. If your device has two analog inputs, you can send the output from each device to each of the separate inputs. The **LC-2** also has a second analog output, the **BROWN** wire. If any of these wires are not being used, isolate and tape the wire(s) in an out of the way location.

The default analog outputs are as follows: Analog output one (Yellow) is $0V = 7.35$ AFR and $5V = 22.39$ AFR. Analog output two (LC-2's Brown) is $1.1V = 14$ AFR and $.1V = 15$ AFR. *Note:* The DLG-1 and LC-2's ground should share the same grounding source as the device to which you are feeding the analog outputs, the easiest way to accomplish this is to run an aux ground wire from the ground point of the DLG-1 and LC-2 to the ground or signal ground of the device you are interfacing with.

2.1.1 Relay Wiring Instructions

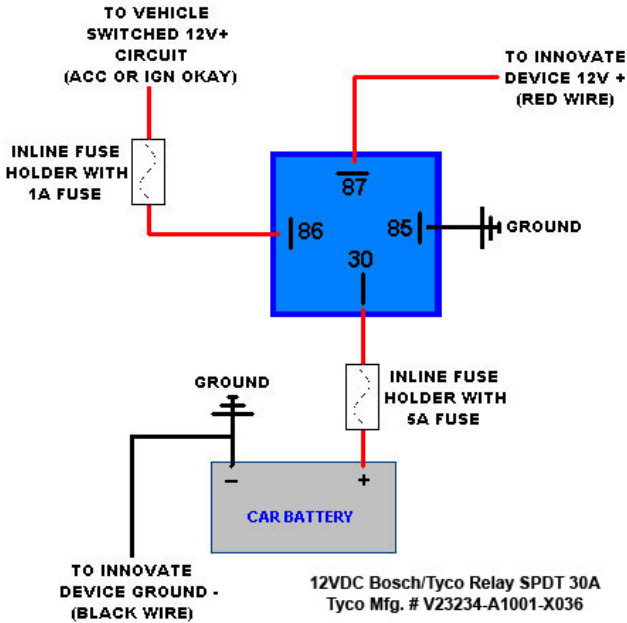

2.2 DLG-1 Mounting and Routing

The DLG-1 gauge fits in any standard 2 1/16" (52mm) gauge pod. Mounting of the gauge should be done in such a manner that the cables are not being forcefully pulled and strained from the gauge itself. Route the sensor and solenoid cables avoiding contact with the exhaust system and other vehicle components that could damage the cable. Also avoid routing the cables near ignition components or other sources of RF (radio frequency) and EMI (Electromagnetic interference) noise.

2.3 LC-2 Mounting

The LC-2 controller body should be mounted inside the cabin or in another dry, protected location away from the elements. Physically mount the unit away from all ignition or stereo components and other potentially RF or EMI emitting sources.

Route the sensor cable in a manner that avoids contact with the exhaust piping and other extreme heat sources that could melt the cable. Also avoid routing the sensor cable near ignition components or other sources of RF (radio frequency) and EMI (Electromagnetic interference).

2.4 Interfacing the DLG-1 with the LC-2

1. Verify that both the DLG-1 and LC-2 are powered OFF.
2. Both the DLG-1 and LC-2 have 4-pin Molex connectors labeled IN and OUT. Using P/N 3846 included in your kit, connect the OUT port of the LC-2 to the IN port of the DLG-1.
3. Turn the key to the accessory position (do not start the engine) to power up both devices. Once the DLG-1 is powered up, press and HOLD both interface buttons for 5 seconds. This will sync the connection from LC-2 to the DLG-1.



It might be necessary to resync the DLG-1 with the LC-2 by pressing and HOLDING the two interface buttons if additional MTS devices are added to the serial chain (serial IN port of the LC-2.)

2.5 Wideband Oxygen Sensor Setup

2.5.1 Oxygen Sensor Placement

- Weld the bung at least **24 inches downstream** of the exhaust port outlet (after the collector), or 24 inches after the turbocharger if so equipped. The bung should be welded before the X or H pipe if so equipped.
- Using a clock as reference, mount the bung between the **9:00 o'clock and 3:00 o'clock position**. Welding the bung in the lower section of the exhaust pipe can result in sensor damage caused by condensation making contact with the sensor's internal heating element.
- A **1" bung** (provided in the kit) will best protect the sensor. When fully threaded, the sensor's tip will sit flush with the exhaust pipe, this does **not** adversely affect the readings.
- The bung should always be welded before the Catalytic Converter. Welding the bung after the catalytic converter will skew the readings toward lean. The skew in readings will vary with engine load and the efficiency of the catalytic converter.
- Leaded fuel and two stroke applications will reduce the sensor's life. There are many other factors that dictate the sensor's lifespan so it is impossible to predict it's total longevity.

- Exhaust leaks, camshaft overlap, and open (shorty) exhausts will cause false lean readings at light engine loads. Typically, once the engine is under load and the exhaust gas volume increases, you will see accurate readings.
- When installed in the exhaust, the oxygen sensor must be connected to a powered, functional wideband controller (no error codes) whenever the engine is running. An un-powered sensor will be damaged in a short period of time when exposed to exhaust gas.
- Do not pre-warm the sensor before starting the engine, simply start the engine as normal. Allowing the sensor to pre-warm before starting the engine will increase the possibility of damaging the sensor from shock-cooling.
- The maximum temperature of the sensor at the bung (the sensor mounting location) should not exceed 500 °C or 900 °F. If these temperatures are exceeded in your application you should install the Innovate Motorsports HBX-1 heat sink bung extender. (p/n 3729.)



As the O2 sensor measures the oxygen content of the exhaust gas to provide an accurate O2 reading, even a small pin-hole leak in a poorly welded sensor bung will affect the accuracy and performance of your O2 sensor. Remember, any deviation from the instructions provided for proper sensor installation will lead to inaccurate O2 readings.

2.5.2 Sensor Calibration

Once both the DLG-1 and the LC-2 have been wired, interfaced together, and a suitable location has been found for both the devices and sensors, it is time to perform the sensor calibration. Innovate Motorsports' 'Direct Digital' wideband measurement principal allows you to calibrate the sensor to compensate for sensor wear. This procedure takes just a few moments and it will ensure the most accurate readings throughout the oxygen sensor's life.

This procedure is required anytime a NEW oxygen sensor is installed.

The calibration procedure requires that the oxygen sensors be in **free air**, this means removed from the exhaust system completely.

The procedure below will allow both sensors (from the DLG-1 and LC-2) to be calibrated at the same time.

1. With the **sensors disconnected**, apply power to the DLG-1 and LC-2.

Confirm that both channel A and B are reporting an E2 error code. This is an error code, indicating that no sensor is detected. Leave unit powered on for a minimum of 30 seconds.

2. **Power down** the DLG-1 and LC-2 and attach the oxygen sensors using the cable provided. When making these connections, make sure they are fully seated and locked. Again, make sure that the sensors are in free air (not in the exhaust).
3. **Power up** the DLG-1 and LC-2.

The gauge will show that the sensors are warming up, this is indicated by "HTR." After 30-60 seconds, the display will switch from "HTR" and quickly flash "CAL", indicating that the sensor is being calibrated.

The calibration procedure has completed and the system is now ready for use.

Important: You can disconnect and reconnect the sensor and sensor cable for installation without losing your calibration. However, if you power up the DLG-1 or LC-2 without a sensor connected, **your calibration will be reset** (see step #1 above).

2.5.3 Calibration Schedule

Normally aspirated daily driver:

- Calibrate before installation of new sensor
- Calibrate new sensor again after 3 month of use
- Thereafter calibrate once a year or every 20,000 miles, whichever comes first

Turbo car, daily driver (richer mixture):

- Calibrate before installation of new sensor
- Calibrate new sensor again after 3 month of use
- Thereafter calibrate twice a year or every 10,000 miles, whichever comes first

Race car

- Calibrate before first installation of new sensor
- Calibrate once per race weekend

3 DLG-1 Configuration

The DLG-1 can be setup to display AFR or Lambda. When configured to display AFR, it can be setup for any fuel type setting. The configuration can be done on the gauge itself by utilizing the interface buttons or by connecting the unit to the LM Programmer software.

Note: The wideband settings are universal, that is, they apply to both A/F channels (both internal and external.)

3.1 Entering Setup Configuration

The DLG-1 can be configured directly from the gauge itself or by connecting it to a computer with the LM Programmer software.

3.1.1 Configuration using DLG-1's interface buttons

1. From the main screen, press and HOLD the left interface button to put the gauge in setup mode
2. Pressing either the left or right interface buttons will allow you to cycle through the 2 different setup parameters in the menu.
3. Once the desired setup parameter is displayed, press and HOLD the left interface button to make a change. Once the parameter's configuration has been entered it will start flashing.
4. Make changes by using the left or right interface buttons.
5. Once in setup mode, pressing and HOLDING both interface buttons together will move you to the menu or main screen. The gauge will revert back to the main screen if no there have been no button presses for 15 seconds.

3.1.2 Configuration using the LM Programmer software

Refer to chapter 4, Logworks 3 & LM Programmer Software Package to gain access to the software.

1. Power the DLG-1 OFF.
2. Disconnect any devices connected to the serial IN port
3. Connect the OUT port of the DLG-1 to the provided serial programming cable. Connect the other end of the serial programming cable to your computer. If your computer does not have a serial port, you can purchase a USB to Serial adapter from Innovate Motorsports (P/N 3733) or use any USB to serial adaptor that includes drivers. Make sure that nothing is connected to the IN port of the DLG-1
4. Power up the DLG-1.

5. Launch **LM Programmer**. The LM Programmer application can be launched from *Start->Programs->LogWorks3->LM Programmer* from the Windows task bar.

Once you have completed your desired changes, press the **Program** button on the lower right on the software application. You will know that the DLG-1 has been programmed successfully when the **Program** button grays out.

3.2 Display Settings (Gauge Abbreviations)

1. **Wideband O2 Units (WB O2 Units)** – Allows the gauge to display O2 units in either AFR or Lambda. Default setting is AFR.
Note: In LM Programmer you can also setup the display to show percentage of Oxygen. Once the measurements are leaner than 7 lambda unit will automatically switch to percentage of O2
2. **Fuel Type** – Change to different fuel types when DLG-1 is setup to display in AFR. Default setting is Gasoline.

4 Logworks 3 & LM Programmer Software Package

The DLG-1 can be connected directly to your Windows computer to log and analyze data with the Logworks software or to configure with LM Programmer. The software is a free download on the Innovate Motorsports' support section of the website.

4.1 Download and Install the Logworks 3 Software

1. Open your web browser and go to the following URL:
<http://www.innovatemotorsports.com/support.php>
2. The LogWorks 3 software download will be the very first thing on the page under the heading Software, click the link to download the software.
3. Double click on the Logworks 3 installer previously downloaded from the support section of the Innovate Motorsports web site.
4. The installer will start, follow the prompts to install the software.
5. Once the software has been installed, the LogWorks software, LM Programmer, manuals, and tools can then be located by navigating through *Start->Programs->LogWorks3*.

4.2 LM Programmer

LM Programmer is used to configure settings on your DLG-1.

1. Connect the OUT port of the DLG-1 to the provided serial programming cable. Connect the other end of the serial programming cable to your computer. If your computer does not have a serial port, you can purchase a USB to Serial adapter from

Innovate Motorsports (P/N 3733) or use any USB to serial adaptor that includes drivers. Make sure that nothing is connected to the IN port of the DLG-1

2. Disconnect any other MTS devices connected in the serial IN of the DLG-1.
3. Power up the DLG-1.
4. Launch LM Programmer. The LM Programmer application can be launched from *Start->Programs->LogWorks3->LM Programmer* from the Windows task bar.

4.2.1 Programming Analog Output

Connect the DLG-1 to the computer and launch LM Programmer. Select the Analog Output tab. The analog output configuration screen shows voltage versus Lambda for the analog output. The graph display is automatically scaled to the selected voltages values. The configuration screen allows the user to specify a minimum and maximum lambda or A/F value to a corresponding voltage range.

By selecting the 'use Air-Fuel-Ratio' button you can change the displayed unit of measure for mixture by AFR instead of Lambda. This does not change the programming, only the unit of measure displayed in the configuration screen.

Click the 'Program' button to upload your modified A/F or lambda scaling data into the DLG-1. Once the unit has been programmed, the 'Program' button will grey out.

Factory Programmed Default:

The analog output by default is programmed to output between 0V at 7.35 AFR to 5.0V at 22.39 AFR.

4.2.2 Advanced Analog Output Programming

The 'Advanced' button allows the user to set the analog out update speed and the voltage output during sensor Warm-up and error conditions. The factory defaults of the analog outputs update 1/12 of a second. The default voltage output is set at 0 volts for both the Warm-up and error conditions.

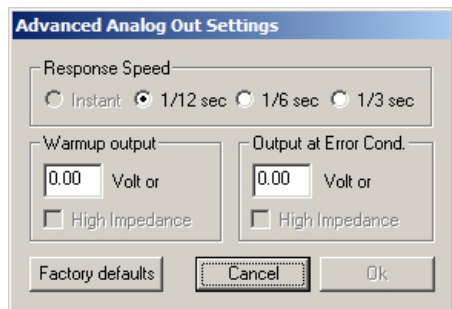

When setting the DLG-1 to the slower response speed settings, the measured mixture data will be averaged over the response time setting before being sent via the analog output.

4.2.3 Updating the Firmware



Do not update the firmware if the versions are the same. A firmware update should only be necessary if there has been a new release that specifically fixes a problem that you are experiencing with the controller.

1. Connect the DLG-1 to the computer and launch LM Programmer.
2. Once connected, LM Programmer will display the current version of the firmware that is installed in the DLG-1. **Do not flash the firmware if the versions are the same.**
3. On the 'Info' tab of LM Programmer you will see a button labeled "Update Firmware," click this button.
4. Select the firmware file with the .dld extension. If there have been revisions to the firmware, you will find them available for download from the Support section of the Innovate Motorsports web site.
5. The software will now prompt you to confirm that you wish to overwrite the firmware currently on your DLG-1.
6. Click OK, the gauge of the DLG-1 will go blank. DO NOT power off or disconnect the DLG-1 from the computer until the firmware progress screen completely disappears. Once finished, you may disconnect the unit from the computer and exit out of the software.

4.2.4 Changing Sensor Type

The *DLG-1* is multi sensor compatible with the Bosch LSU 4.2 and 4.9 sensors. In order to go from one sensor type to another the *DLG-1* must be connected to the LM Programmer software and the appropriate sensor type must be selected. The "Sensor Type to use" setting can be found in the 'Info' tab when LM Programmer connects to the *DLG-1*. Once the sensor type is changed a sensor calibration must be performed with the sensor outside of the exhaust (see Sensor Calibration chapter.)



Sensor Cable P/N	3ft	8ft	18ft
LSU 4.2	3843	3810	3828
LSU 4.9	3890	3887	3889

Sensor P/N	
LSU 4.2	3737
LSU 4.9	3888

Note: All sensor cables for the LSU 4.9 are easily identified by a '4.9' marking molded on the sensor connector side.



Use the appropriate sensor cable for the sensor type as each sensor has a different style connector. Spliced cable can not only affect

the wideband controller's performance but in worst cases it can damage the sensor and/or controller.



Selecting the wrong sensor type to the sensor being used will not only give you erroneous readings and/or errors. It can also permanently damage the sensor.

4.3 Logging data from your DLG-1 with LogWorks

1. Connect the OUT port of the DLG-1 to the provided serial programming cable. Connect the other end of the serial programming cable to your computer. If your computer does not have a serial port, you can purchase a USB to Serial adapter from Innovate Motorsports (P/N 3733) or use any USB to serial adaptor that includes drivers. Power up the system.
2. Launch LogWorks. The LogWorks application can be launched from *Start->Programs->LogWorks3->Logworks3* from the Windows task bar.
3. Once LogWorks launches go to *File->Connect*. You will be prompted to connect to the serial COM port. Select the comport the device is connected to and then click Connect.
4. *To start recording go to File->New Realtime Log* or, in the Toolbar, click on the  Tool.

4.3.1 Adding and Logging MTS channels

The Innovate Motorsports' MTS (Modular Tuning System) allows you to daisy chain multiple devices together via the serial IN and OUT connectors to form one single synchronous log. MTS log chains can consist of a single unit connected directly to a laptop, two units (LC-2 and DLG-1 together), or multiple devices connected together, up to 32 channels.

Appendix A: Limited Warranty

LIMITED WARRANTY

Innovate stands behind the quality of its products. Innovate makes the following warranty to purchasers of its products: All new Innovate products carry a one year warranty from the date of purchase. If proof of purchase cannot be provided, warranty will be determined by date of manufacture.

When Warranty Void

This warranty shall terminate and Innovate shall have no obligation pursuant to it if (i) your Innovate product has been modified or repaired in a manner not previously authorized by Innovate in writing, (ii) the identification markings on your Innovate product have been removed, defaced, or altered; (iii) your Innovate product was subjected to accident, abuse, shipping damage, or improper use; (iv) your Innovate product was not used or configured as specified in the product manual; or (v) your Innovate product was subjected to operating conditions more severe than those specified in the product manual.

Exclusions From This Warranty

Oxygen Sensors are excluded from this warranty.

Repairs Under This Warranty

In the unlikely event that your Innovate hardware product should prove defective during the warranty period, contact Innovate Customer Support at http://www.innovatemotorsports.com/rma_form.php for a return material authorization (RMA). Products returned for service must be securely packed to prevent damage and shipping charges pre paid, along with proof of purchase and the return material authorization number, to the Innovate repair location as instructed by Customer Service. Innovate within a reasonable amount of time from its receipt of your product so shipped, will ship to you, at its option, the repaired product or a new or reconditioned product of comparable or greater specified functionality. All repaired or replacement products shall be warranted for the remainder of the original product warranty.

Disclaimer

INNOVATE MAKES NO OTHER EXPRESS OR IMPLIED WARRANTY WITH RESPECT TO YOUR INNOVATE PRODUCT OTHER THAN THE LIMITED WARRANTY SET FORTH ABOVE. No Innovate dealer, agent, or employee is authorized to make any modification, extension, or addition to this warranty, unless enforceable or unlawful under applicable law. INNOVATE DISCLAIMS ALL IMPLIED WARRANTIES, INCLUDING THE IMPLIED WARRANTIES OF MERCHANTABILITY, NONINFRINGEMENT, AND FITNESS FOR A PARTICULAR PURPOSE, AND THE LIABILITY OF INNOVATE, IF ANY, FOR DAMAGES RELATING TO ANY ALLEGEDLY DEFECTIVE PRODUCT SHALL UNDER ANY TORT, CONTRACT, OR OTHER LEGAL THEORY BE LIMITED TO THE ACTUAL PRICE PAID FOR SUCH PRODUCT AND SHALL IN NO EVENT INCLUDE INCIDENTAL, CONSEQUENTIAL, SPECIAL, OR INDIRECT DAMAGES OF ANY KIND EVEN IF INNOVATE IS AWARE OF THE POSSIBILITY OF SUCH DAMAGES. Some states do not allow limitations on how long an implied warranty lasts or the exclusion or limitation of incidental or consequential damages, so the above limitations or exclusions may not apply to you.

Appendix B: DLG-1 Error Codes and Troubleshooting Tips

Error Code	Error Message	Likely Root Cause	Fix
Error 1	Heater circuit shorted	Short in sensor	Replace sensor.
Error 2	Heater circuit open	1. Damaged sensor cable or sensor. 2. Sensor connector not fully seated and locked into position.	1. Verify that all sensor connectors are fully seated and locked into position. 2. Replace sensor 3. Replace sensor cable.
Error 3	Pump cell circuit shorted	1. Short in sensor cable 2. Short in sensor 3. Sensor calibration incorrect	1. Replace sensor cable. 2. Replace sensor. 3. Perform sensor recalibration.
Error 4	Pump cell circuit open	1. Damaged sensor cable or sensor. 2. Connectors not fully seated 3. Sensor calibration incorrect	1. Verify that all sensor connectors are fully seated and locked into position. 2. Perform sensor calibration 3. Replace sensor cable. 4. Replace sensor.
Error 5	Reference cell circuit shorted	1. Short in sensor cable 2. Short in sensor	1. Replace sensor cable. 2. Replace sensor.
Error 6	Reference cell circuit open	1. Damaged sensor cable or sensor. 2. Connectors not fully seated	1. Verify that all sensor connectors are fully seated and locked into position. 2. Replace sensor. 3. Replace sensor cable.
Error 7	System error	System error	Reboot DLG-1 by cycling power.
Error 8	Sensor Timing error (typically a damaged sensor).	1. Sensor over-heating or over-cooling (error condition only occurs at wide open throttle) 2. Sensor is damaged	1. Perform sensor calibration. 2. Move sensor bung as far downstream as possible. 3. Add an HBX-1 (p/n 3729) to isolate the sensor from the pipe. 4. Replace sensor.
Error 9	Supply Voltage too low	Supply voltage too low for sensor regulation	1. Verify you have 12V at your power source and the circuit can support a 3 amp draw.