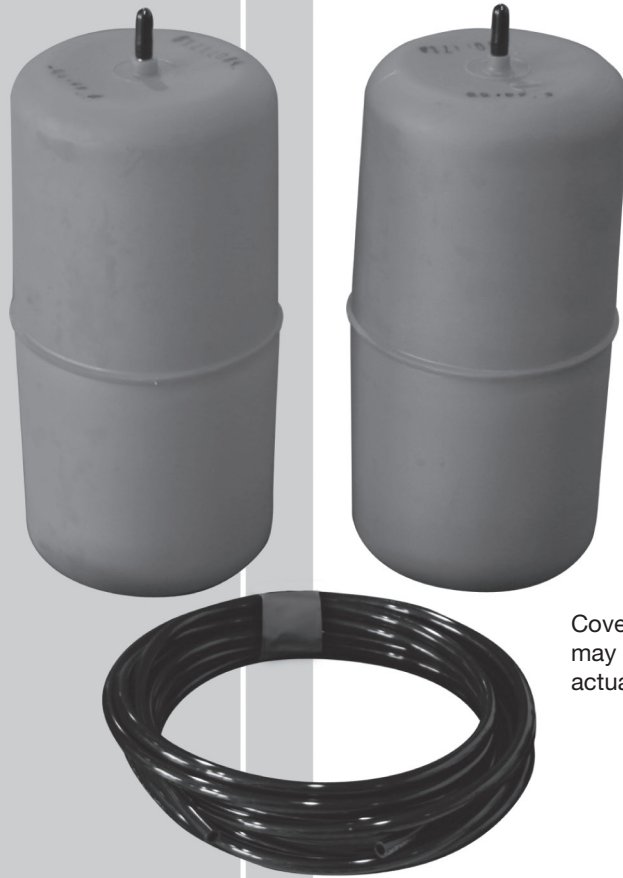


# ***Air Lift*1000**

by AIR LIFT®

## **Kit 60815**

***Honda Odyssey,  
Honda Pilot,  
& Acura MDX***



Cover illustration  
may not depict  
actual kit.



## **INSTALLATION GUIDE**

For maximum effectiveness and safety,  
please read these instructions completely  
before proceeding with installation.

*Failure to read these instructions can result in an  
incorrect installation.*





# TABLE OF CONTENTS



<b>Introduction</b> .....	<b>2</b>
Important Safety Notice .....	2
Notation Explanation .....	2
<b>Hardware and Tools</b> .....	<b>3</b>
Hardware List .....	3
Tools List .....	3
<b>Installing the Air Lift 1000 System.</b> .....	<b>3</b>
Preparing the Vehicle .....	3
Installing the Air Spring .....	4
Installing the Air Line .....	5
Tee Air Line Routing .....	5
Dual Air Line Routing .....	7
Completing the Installation .....	7
<b>Maintenance and Servicing</b> .....	<b>8</b>
Maintenance Guidelines .....	8
Operating Tips .....	8
<b>Product Use</b> .....	<b>9</b>
Frequently Asked Questions .....	9
Tuning the Air Pressure .....	9
Guidelines for Adding Air .....	10
<b>Template</b> .....	<b>11</b>
Drilling Template Verification .....	11
<b>Limited Warranty and Return Policy</b> .....	<b>16</b>
<b>Replacement Information</b> .....	<b>17</b>
<b>Contact Information</b> .....	<b>17</b>

# Introduction

The purpose of this publication is to assist with the installation, maintenance and troubleshooting of the Air Lift 1000 air spring kit.

It is important to read and understand the entire installation guide before beginning installation or performing any maintenance, service or repair. The information here includes a hardware list, tools list, step-by-step installation information, maintenance guidelines and operating tips.

Air Lift Company reserves the right to make changes and improvements to its products and publications at any time. Contact Air Lift Company at **(800) 248-0892** or go online at **[www.airliftcompany.com](http://www.airliftcompany.com)** for the latest version of this manual.

## IMPORTANT SAFETY NOTICE

The installation of this kit does not alter the gross vehicle weight rating (GVWR) or payload of the vehicle. Check your vehicle's owner's manual and do not exceed the maximum load listed for your vehicle.

**Gross Vehicle Weight Rating:** The maximum allowable weight of the fully loaded vehicle (including passengers and cargo). This number — along with other weight limits, as well as tire, rim size and inflation pressure data — is shown on the vehicle's Safety Compliance Certification Label.

**Payload:** The combined, maximum allowable weight of cargo and passengers that the truck is designed to carry. Payload is GVWR minus the base curb weight.

## NOTATION EXPLANATION

Hazard notations appear in various locations in this publication. Information which is highlighted by one of these notations must be observed to help minimize risk of personal injury or possible improper installation which may render the vehicle unsafe. Notes are used to help emphasize areas of procedural importance and provide helpful suggestions. The following definitions explain the use of these notations as they appear throughout this guide.

** DANGER**

INDICATES IMMEDIATE HAZARDS WHICH WILL RESULT IN SEVERE PERSONAL INJURY OR DEATH.

** WARNING**

INDICATES HAZARDS OR UNSAFE PRACTICES WHICH COULD RESULT IN SEVERE PERSONAL INJURY OR DEATH.

** CAUTION**

INDICATES HAZARDS OR UNSAFE PRACTICES WHICH COULD RESULT IN DAMAGE TO THE MACHINE OR MINOR PERSONAL INJURY.

**NOTE**

*Indicates a procedure, practice or hint which is important to highlight.*

# Hardware and Tools

## HARDWARE LIST

Item	Part #	Description.....Qty
A	46141	Air spring..... 2
B	20315	Hose 15'..... 1
C	10466	Tie strap..... 4
D	21230	Valve cap..... 2
E	21233	5/16" Hex nut..... 4
F	21234	Rubber washer..... 2
G	18411	Star washer..... 2
H	18405	5/16" Flat washer..... 2
I	21236	Tee..... 4
J	21455	Valve..... 4
K	33107	Heat shield kit..... 1

## TOOLS LIST

Description.....Qty	Qty
Hoist or floor jacks.....	2
Safety stands.....	1
Safety glasses.....	1
Metric and standard sockets/ratchet and wrenches.....	1
Drill, drill bits.....	1
Grinder or dremel tool.....	1
Pliers.....	1
Air compressor or compressed air source.....	1
Spray bottle with dish soap/water solution.....	1

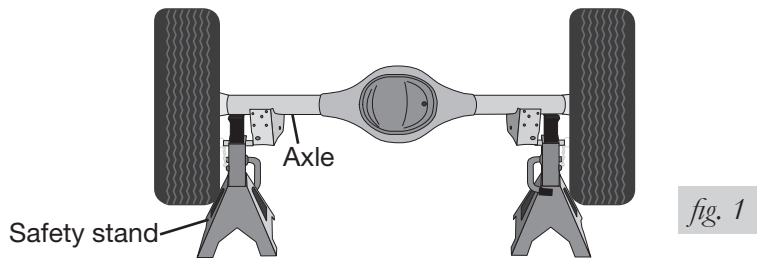


Missing or damaged parts? Call Air Lift customer service at (800) 248-0892 for a replacement part.

# Installing the Air Lift 1000 System

## PREPARING THE VEHICLE

1. Jack up the rear of the vehicle or raise on a hoist. Support the frame with safety stands so that the wheels hang (fig. 1). Remove the wheels.



2. Position a floor jack at the connecting point of the lower control arm (under the attaching flange bolt) and knuckle (fig. 2).
3. Remove the flange bolt that connects the lower control arm to the knuckle.



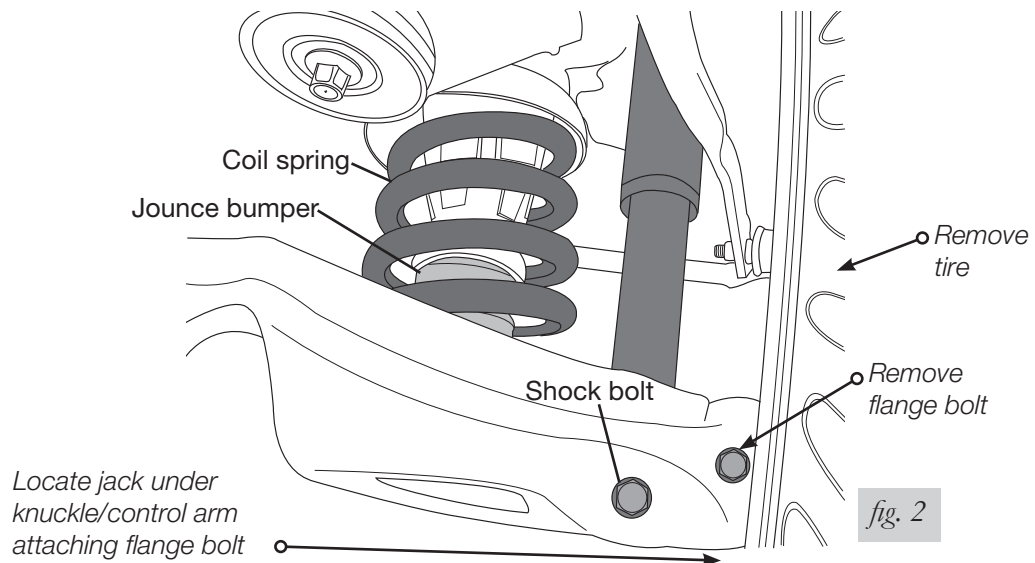
**THE LOWER CONTROL ARM IS UNDER PRESSURE FROM THE COIL SPRING. USE CAUTION DURING THIS STEP FOR SAFETY PURPOSES.**

4. Lower the floor jack gradually until tension is released and the coil spring can be removed.

## NOTE

*It may be necessary to remove the lower shock bolt in order for the lower control arm to move far enough to remove the coil spring.*

5. Remove the coil spring.



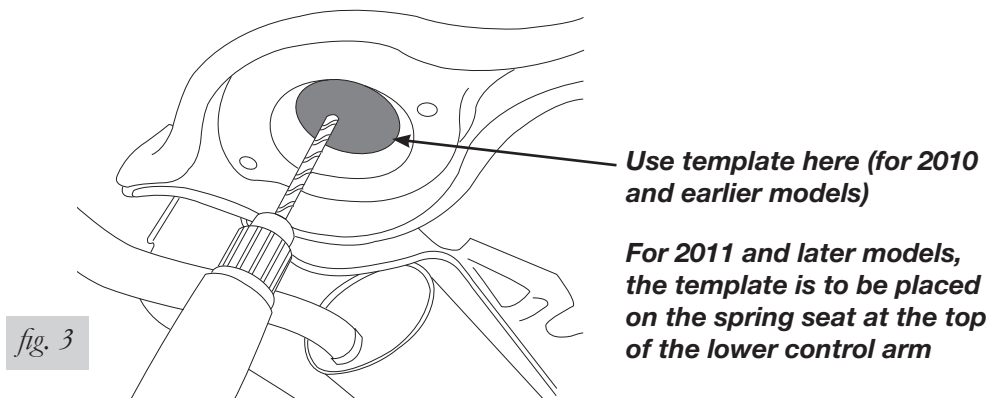
## INSTALLING THE AIR SPRING

- 1a. For 2010 and earlier models, cut out the template provided on page 11 and attach it with tape to the underside of the lower control arm, aligning the template so that the hole to be drilled is toward the inside of the vehicle (fig. 3).
- 1b. For 2011 and later models, cut out the template provided on page 11 and attach it with tape to the top side of the lower control arm, in the spring seat area, aligning the template so that the hole to be drilled is toward the inside of the vehicle.

### NOTE

*It may be necessary to adjust the outer diameter of the template for some models.*

2. Center-punch and drill a 3/4" hole to provide valve stem clearance (fig. 3).



### NOTE

*As an option to a 3/4" drill bit, drill the hole using a 1/2" bit and grind the hole open using an air grinder or dremel tool.*

3. Insert the air spring cylinder into the coil spring with the stem down.
4. Install the spring back into the vehicle and raise the lower control arm up enough to insert and attach the flange bolt that holds the lower control arm to the knuckle that was previously removed. Do not tighten at this time.

### NOTE

*The lower control arm is indexed so that the coil spring mounts in a certain way. Make sure the coil spring indexes properly before attaching the flange bolt.*

5. Raise and lower the control arm up and down while watching the stem on the air spring cylinder. If interference is noted from the lower control arm hitting on the stem or cylinder boss, grind the control arm for clearance.

6. Raise the control arm up far enough to just pick the vehicle up off the safety jacks and torque the flange bolt to 33 lb./ft. (45Nm).
7. Reattach the lower shock bolt if removed previously.
8. Repeat “Preparing the Vehicle” and “Installing the Air Spring” steps 1-6 for the other side of the vehicle.

## INSTALLING THE AIR LINE

A tee air line installation is recommended. If the weight in the vehicle varies from one side to the other and unequal pressures are needed to level the load or compensate for axle torque transfer in racing applications, use dual air lines (see page 7).

### TEE AIR LINE ROUTING

#### CAUTION

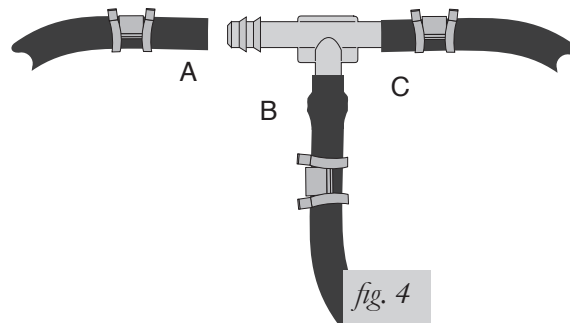
TO PREVENT THE AIR LINE FROM MELTING, MAINTAIN AT LEAST 8” FROM THE EXHAUST SYSTEM TO THE AIR LINE.

1. Locate the desired tee location on the frame rail or cross member. Determine and cut an adequate length of air line to reach from the tee to the left and right side air springs.

#### CAUTION

LEAVE SUFFICIENT AIR LINE SLACK TO PREVENT ANY STRAIN ON THE FITTING DURING AXLE MOTIONS.

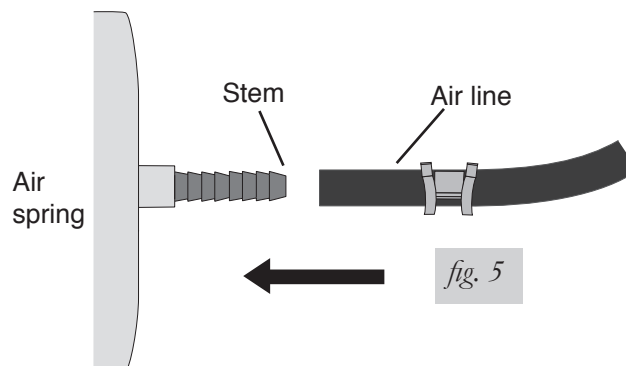
2. Slide an air line clamp onto the air line.
3. Push the air line over one side of the tee until all the barbs are covered. With a pair of pliers, slide the air line clamp forward until it fully covers the barbed section. Repeat the entire procedure for the other leg of the tee (fig. 4).
4. Route the air line along the cross member and either the lower control arm or the upper spring seat to the air spring.



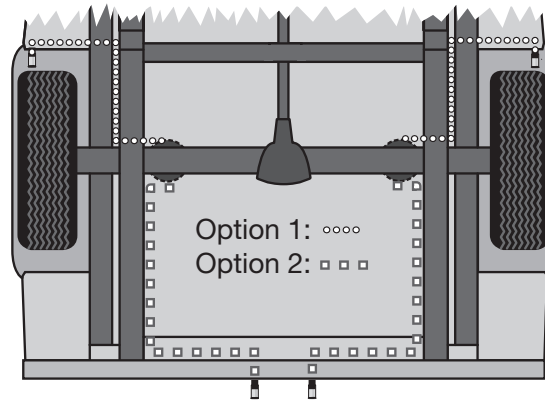
#### Use this procedure for all air line connections:

- a. Slide the air line clamp onto the air line.
- b. Push the air line over the barbed stem.
- c. Compress the ears on the air line clamp with pliers and slide it forward to fully cover the barbed section.

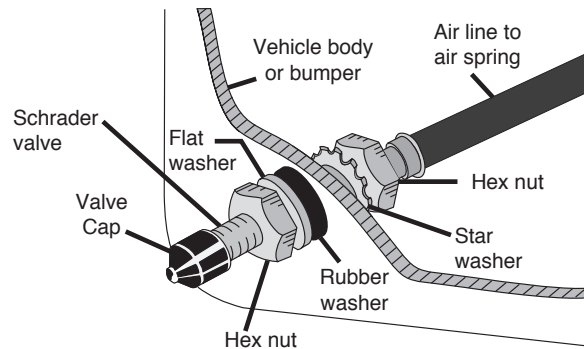
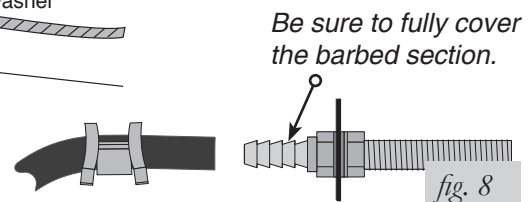
5. Insert the air line through the spring seat and spacers.
6. Push the air line onto the stem, covering all the barbs (fig. 5). With the pliers, slide the air line clamp upward until it fully covers the barbed section.



7. Push the remaining air line over the last fitting on the tee and route it along the frame to the desired inflation valve location. Attach the air line with plastic straps or wire.
8. Select a location for the inflation valve in the gas cap well, the trunk, rear bumper, fender flange or behind the license plate, ensuring that the valve will be protected and accessible with an air hose (fig. 6).

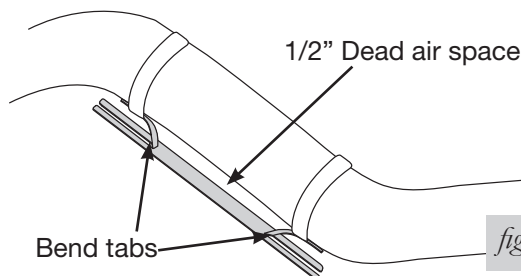

*fig. 6*

9. Drill a 5/16" hole for the inflation valve and mount as shown (fig. 7). The rubber washer serves as an outside weather seal.
10. Slide the air line clamp over the air line. Push the air line onto the fitting covering all barbs. Using pliers, slide the air line clamp forward until it fully covers the barbed section (fig. 8).


*fig. 7*

*fig. 8*
**NOTE**

*Installing the heat shield is only necessary on the Honda Odyssey.*

11. To install the heat shield, bend its tabs to provide a 1/2" dead air space between the exhaust pipe and the heat shield (fig. 9).
12. Attach the heat shield to the exhaust pipe using the clamps. Bend the heat shield for maximum clearance to the air spring (fig. 9).


*fig. 9*



13. Raise the axle or lower the vehicle body until the air springs lightly touch the upper spring seat and lower spacers.
14. Check the tail pipe clearance and ensure that it is at least 2-3 inches from the air spring. If necessary, loosen the clamps and rotate or move to obtain additional clearance. Reattach the shock absorbers if removed earlier in the installation.

 **CAUTION**

DO NOT INFLATE AIR SPRINGS BEFORE READING THE MAINTENANCE AND OPERATION SECTION.

15. Continue to “Completing the Installation.”

## DUAL AIR LINE ROUTING

 **CAUTION**

TO PREVENT AIR LINE FROM MELTING, KEEP IT AT LEAST 8” FROM EXHAUST SYSTEM.

1. Select a location for the inflation valves in the rocker panel flange, or rear bumper, assuring that each valve will be protected and accessible with an air hose.
2. Determine and cut an adequate length of air line to reach from the valve location to the left side air spring.

 **CAUTION**

LEAVE SUFFICIENT AIR LINE SLACK TO PREVENT ANY STRAIN ON FITTING DURING AXLE MOTIONS.

3. Insert the air line through the spring seat and spacer.
4. Slide the air clamp onto the cut air line.
5. Push the air line onto the stem, covering all the barbed section (see fig. 7). With pliers slide the air line clamp forward until it fully covers the barbed section.
6. Repeat process for the right side.
7. Drill a 5/16 “ hole for the inflating valves and mount as illustrated. The rubber washer is for an outside weather seal (see fig. 9).
8. Route the air line along the control arm and frame to the inflation valve location and cut off the excess.
9. Slide a clamp onto the air line and push the air line over the fitting, covering all the barbs. With pliers slide the air line clamp forward until it fully covers the barbed section (see fig. 8).
10. Raise the axle or lower body until the air springs lightly touch the upper spring seat and lower spacers.
11. Check the tail pipe clearance and ensure that it is at least 2-3 inches from the air springs. If necessary, loosen the clamps and rotate or move to obtain additional clearance. If you are installing this kit on a Honda Odyssey see page 6 for instruction on how to install the heat shield. Reattach the shock absorbers if removed earlier in the installation.

 **CAUTION**

DO NOT INFLATE AIR SPRINGS BEFORE READING THE MAINTENANCE AND OPERATION SECTION.

## COMPLETING THE INSTALLATION

1. Inflate the air springs to 35 PSI. Test for air leaks by applying a liquid solution of 1/5 dish soap to 4/5 water to all valve cores, fittings and connections.
2. Lower the vehicle to the ground. Read Maintenance and Servicing for proper care of the air springs.
3. Recheck air pressure after 24 hours. A 2-4 PSI loss after initial installation is normal. If pressure has dropped more than 5 PSI, retest for leaks.

# Maintenance and Servicing

Minimum Air Pressure	Maximum Air Pressure
<b>5 PSI</b>	<b>35 PSI</b>
FAILURE TO MAINTAIN CORRECT MINIMUM PRESSURE (OR PRESSURE PROPORTIONAL TO LOAD), BOTTOMING OUT, OVER-EXTENSION OR RUBBING AGAINST ANOTHER COMPONENT WILL VOID THE WARRANTY.	

## MAINTENANCE GUIDELINES

By following these steps, vehicle owners will obtain the longest life and best results from their air springs.

1. Check the air pressure weekly.
2. Always maintain at least the recommended minimum air pressure to prevent the air spring from being pinched. Never inflate beyond the maximum air pressure.
4. If you develop an air leak in the system, use a soapy water solution of 1/5 liquid dish soap and 4/5 water to check all air line connections and the inflation valve core before deflating and removing the air spring.
5. Always add air to springs in small quantities, checking the pressure frequently. Sleeves require less air volume than a tire and inflate quickly.

## OPERATING TIPS

1. Inflate your air springs to 35 PSI before adding the payload. This will allow the air cylinder to properly mesh with the coil spring. After the vehicle is loaded, adjust your air pressure down to level the vehicle and for ride comfort.
2. When carrying a payload it will be helpful to increase the tire inflation pressure in proportion to any overload condition. Air Lift recommends a 2 PSI increase above normal for each 100 pounds additional load on the axle.

**CAUTION**

DO NOT EXCEED THE VEHICLE MANUFACTURERS' MAXIMUM GROSS VEHICLE WEIGHT RATING.

# Product Use

## FREQUENTLY ASKED QUESTIONS

**Q. Will installing air springs increase the weight ratings of a vehicle?**

No. Adding air springs will not change the weight ratings (GAWR, GCWR and/or GVWR) of a vehicle. Exceeding the GVWR is dangerous and voids the Air Lift warranty.

**Q. Is it necessary to keep air in the air springs at all times and how much pressure will they need?**

The minimum air pressure should be maintained at all times. The minimum air pressure keeps the air spring in shape, ensuring that it will move throughout its travel without rubbing or wearing on itself.

**Q. Is it necessary to add a compressor system to the air springs?**

No. Air pressure can be adjusted with any type of compressor as long as it can produce sufficient pressure to service the springs. Even a bicycle tire pump can be used, but it's a lot of work.

**Q. How long should air springs last?**

If the air springs are properly installed and maintained they can last indefinitely.

**Q. Will raising the vehicle on a hoist for service work damage the air springs?**

No. The vehicle can be lifted on a hoist for short-term service work such as tire rotation or oil changes. However, if the vehicle will be on the hoist for a prolonged period of time, support the axle with jack stands in order to take the tension off of the air springs.

## TUNING THE AIR PRESSURE

Pressure determination comes down to three things — level vehicle, ride comfort, and stability.

**1. Level vehicle**

If the vehicle's headlights are shining into the trees or the vehicle is leaning to one side, then it is not level (fig. 10). Raise the air pressure to correct either of these problems and level the vehicle.

**2. Ride comfort**

If the vehicle has a rough or harsh ride it may be due to either too much pressure or not enough (fig. 11). Try different pressures to determine the best ride comfort.

**3. Stability**

Stability translates into safety and should be the priority, meaning the driver may need to sacrifice a perfectly level and comfortable ride. Stability issues include roll control, bounce, dive during braking and sponginess (fig. 12). Tuning out these problems usually requires an increase in pressure.



Bad headlight aim

fig. 10



Rough ride

fig. 11



Sway and body roll

fig. 12

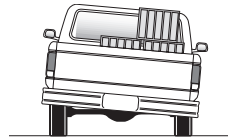
## GUIDELINES FOR ADDING AIR

1. Start with the vehicle level or slightly above.
2. When in doubt, always add air.
3. For motorhomes, start with 50-100 PSI in the rear because it can be safely assumed that it is heavily loaded.
4. If the front of the vehicle dives while braking, increase the pressure in the front air bags, if equipped.
5. If it is ever suspected that the air bags have bottomed out, increase the pressure (fig. 13).
6. Adjust the pressure up and down to find the best ride.
7. If the vehicle rocks and rolls, adjust the air pressure to reduce movement.
8. It may be necessary to maintain different pressures on each side of the vehicle. Loads such as water, fuel, and appliances will cause the vehicle to be heavier on one side (fig. 14). As much as a 50 PSI difference is not uncommon.

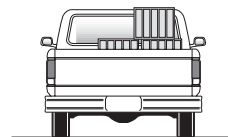


Bottoming out

*fig. 13*



Unlevel



Level

*fig. 14*

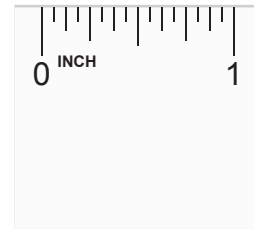
# Template

## DRILLING TEMPLATE VERIFICATION

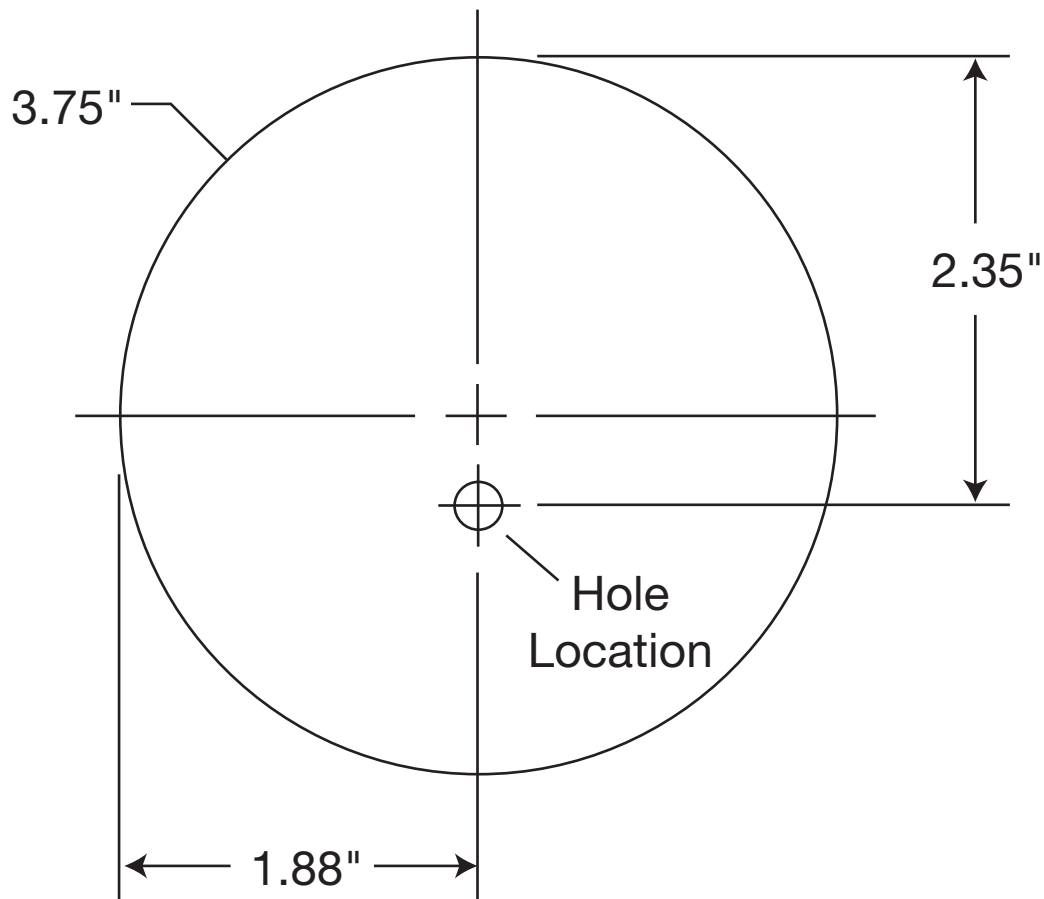
 **CAUTION**

IMPORTANT: PRINT THIS MANUAL AT 100% SCALE. THIS MANUAL CONTAINS A DRILLING TEMPLATE, WHICH WOULD BE RENDERED INCORRECT IN DIMENSION IF PRINTED WITH ANY SCALING. USING AN INCORRECT TEMPLATE TO DRILL HOLES MAY CAUSE DAMAGE TO THE VEHICLE!

PLEASE REFER TO THE ONE-INCH SCALE (FIG. 15) AND USE A MEASURING TOOL TO CONFIRM THAT THE PRINTED SCALE MEASURES ONE-INCH TO VERIFY THAT THE TEMPLATE HAS BEEN PRINTED AT 100% SCALE. IF IT IS PRINTED AT ANY SCALE OTHER THAN 100%, YOU COULD END UP DRILLING IN THE WRONG LOCATIONS ON THE VEHICLE.



*fig. 15*





# Notes

# Notes



---

# Notes

# Limited Warranty and Return Policy

## WHAT THIS WARRANTY COVERS

Air Lift Company provides a warranty to the original purchaser of its Load Support Products, for the periods of time listed below, by product line, from the date of original purchase, that the products will be free from defects in workmanship and materials when used on cars and trucks as specified by Air Lift Company and under normal operating conditions, subject to the requirements and exclusions set forth below.

## WHAT THIS WARRANTY DOES NOT COVER

The warranty does not apply to products that have been improperly applied, improperly installed, or which have not been maintained in accordance with installation instructions furnished with all products. This warranty does not apply and is void if damage or failure is caused by: accident, abuse, misuse (including but not limited to racing or off-road activities or commercial use), abnormal use, faulty installation, liquid contact, fire, earthquake or other external cause; operating the product outside Air Lift Company's instructions, specifications or guidelines; or service, alteration, maintenance or repairs performed by anyone other than Air Lift Company to the product from its purchased condition. This warranty also does not apply to: consumable parts, such as batteries; cosmetic damage, including but not limited to scratches or dents; defects caused by normal wear and tear or otherwise due to the normal aging of the product, or if any serial or identification number has been removed or defaced from the product. Air Lift Company reserves the right to change the design of any product without assuming any obligation to modify any product previously manufactured.

## LIMITATION OF LIABILITY

To the extent permitted by law, this warranty and the remedies set forth herein are exclusive and in lieu of all other warranties, remedies and conditions, whether oral, written, statutory, express or implied. AIR LIFT COMPANY DISCLAIMS ALL STATUTORY AND IMPLIED WARRANTIES, INCLUDING WITHOUT LIMITATION, WARRANTIES OF MERCHANTABILITY AND FITNESS FOR A PARTICULAR PURPOSE AND WARRANTIES AGAINST HIDDEN OR LATENT DEFECTS TO THE EXTENT PERMITTED BY LAW. To the extent such warranties cannot be disclaimed, such implied warranties shall apply only for the warranty period specified above. Please note that some states do not allow limitation on how long an implied warranty (or condition) lasts. So the above limitation may not apply to you.

Except as provided in this warranty and to the extent permitted by law, Air Lift Company shall not be liable for any direct, special, incidental or consequential damages resulting from any breach of warranty or condition, or arising in connection with the sale, use or repair of air lift products, or under any other legal theory, including but not limited to loss of use, loss of revenue, loss of actual or anticipated profits, loss of the use of money, loss of business, loss of opportunity, loss of goodwill, and loss of reputation. Air Lift Company's maximum liability shall not in any case exceed the purchase price paid by you for the Air Lift product. Please note that some states do not allow the exclusion or limitation of incidental or consequential damages, so the above limitation or exclusion may not apply to you.

## HOW TO GET SERVICE

If a defect in workmanship or materials causes your Air Lift product to become inoperable within the warranty period, before returning any defective product, call Air Lift Company at (800) 248-0892 in the U.S. and Canada (elsewhere, (517) 322-2144) to obtain a Returned Materials Authorization (RMA) number. The consumer shall be responsible for removing (labor charges) the defective product from the vehicle and returning it, shipping costs prepaid, to Air Lift Company for verification. Returns to Air Lift Company must be postage prepaid and sent to: Air Lift Company • 2727 Snow Road • Lansing, MI • 48917. You must prove to the satisfaction of Air Lift Company the date of original purchase of your Air Lift product. You must also enclose the RMA number and a return address. A minimum \$10 shipping and handling charge will apply to all warranty claims. You must also pack the product to minimize the risk of it being damaged in transit. If we receive a product in damaged condition as the result of shipping, we will notify you and you must seek a claim with the shipper.

## WHAT AIR LIFT COMPANY WILL DO

If you submit a valid claim to Air Lift Company during the warranty period, Air Lift Company will, at its option, repair your Air Lift product or furnish you with a new or rebuilt product. Air Lift Company will not reimburse you for repairs or replacement parts provided by other parties. Your repaired or replacement Air Lift product will be returned to you (subject to payment of the required warranty claim shipping and handling charge) and it will be covered under the warranty for the balance of the warranty period, if any. When a product or part is replaced, any replacement item becomes your property and the replaced item becomes property of Air Lift Company. You are responsible for installation/reinstallation (labor charges) of the product.

## HOW THE LAW RELATES TO THIS WARRANTY

This warranty gives you specific legal rights and you may also have other rights which vary from state to state. By this warranty, Air Lift Company does not limit or exclude your rights except as allowed by law. To fully understand your rights, you should consult the laws of your state.

## SPECIFIC LOAD SUPPORT WARRANTY PERIODS BY PRODUCT LINE

LoadLifter 5000™ Ultimate .....	Lifetime Limited	WirelessAIR™ .....	2 Year Limited
LoadLifter 5000™ .....	Lifetime Limited	WirelessONE™ .....	2 Year Limited
RideControl™ .....	Lifetime Limited	LoadController™ Single and Dual.....	2 Year Limited
Air Lift 1000™ .....	Lifetime Limited	LoadController™ I and II .....	2 Year Limited
AirCell™ .....	Lifetime Limited	SmartAir™ II .....	2 Year Limited
SlamAir™ .....	Lifetime Limited	Other Accessories.....	2 Year Limited

## Replacement Part Information

If replacement parts are needed, contact the local dealer or call Air Lift customer service at **(800) 248-0892**. Most parts are immediately available and can be shipped the same day.

**Contact Air Lift Company customer service at (800) 248-0892 first if:**

- Parts are missing from the kit.
- Need technical assistance on installation or operation.
- Broken or defective parts in the kit.
- Wrong parts in the kit.
- Have a warranty claim or question.

**Contact the retailer where the kit was purchased:**

- If it is necessary to return or exchange the kit for any reason.
- If there is a problem with shipping if shipped from the retailer.
- If there is a problem with the price.

## Contact Information

<b>Mailing address</b>	P.O. Box 80167 Lansing, MI 48908-0167
<b>Shipping address for returns</b>	2727 Snow Road Lansing, MI 48917
<b>Phone</b>	Toll free: (800) 248-0892 International: (517) 322-2144
<b>Email</b>	service@airliftcompany.com
<b>Web address</b>	www.airliftcompany.com

## Need Help?

Contact Air Lift Company customer service department by calling (800) 248-0892. For calls from outside the USA or Canada, dial (517) 322-2144.



*Thank you for purchasing Air Lift products — the professional installer's choice!*

Air Lift Company • 2727 Snow Road • Lansing, MI 48917 or P.O. Box 80167 • Lansing, MI 48908-0167  
Toll Free (800) 248-0892 • Local (517) 322-2144 • Fax (517) 322-0240 • [www.airliftcompany.com](http://www.airliftcompany.com)

Printed in the USA  
JPR-0716