

Air Lift™ **PERFORMANCE**

Kits 78610 & 78609

BMW E8X/E9X
Non M series

Rear Application



AIR LIFT™
PERFORMANCE

INSTALLATION GUIDE

IMPORTANT: WHEN PURCHASING KIT 78609 WITHOUT REAR SHOCKS, YOU MUST ACQUIRE BMW E9X M3 SHOCKS. E8X/E9X REAR SHOCKS WILL NOT WORK WITH THIS KIT.

For maximum effectiveness and safety, please read these instructions completely before proceeding with installation.

Failure to read these instructions can result in an incorrect installation.

TABLE OF CONTENTS

Introduction	2
Notation Explanation	2
Important Safety Notices	2
Installation Diagram	3
Hardware List	3
Installing the Air Suspension	4
Preparing the Vehicle	4
Removing the Rear Suspension	5
Assembling the Air Spring Upper Bracket and Air Fitting	7
Installing the Air Suspension	8
Installing Shocks	10
Damping Adjustment	12
Aligning the Vehicle	12
Adjusting Extended or Drop Height Using Lower Mount	13
Before Operating	15
Installation Checklist	15
Product Use, Maintenance and Servicing	16
Suggested Driving and Maximum Air Pressures	16
Maintaining and Operating	16
Troubleshooting Guide	16
Frequently Asked Questions	16
Tuning the Air Pressure	17
Checking for Leaks	17
Fixing Leaks	17
Warranty & Return Policy	18
Replacement Information	18
Contact Information	18

Introduction

The purpose of this publication is to assist with the installation, maintenance and troubleshooting of this BMW E8X/E9X Performance kit.

It is important to read and understand the entire installation guide before beginning installation or performing any maintenance, service or repair. The information includes a hardware list, step-by-step installation information, maintenance tips, safety information and a troubleshooting guide.

Air Lift Performance reserves the right to make changes and improvements to its products and publications at any time. For the latest version of this manual, contact Air Lift Performance at (800) 248-0892 or visit our website at www.airliftperformance.com.

NOTATION EXPLANATION

Hazard notations appear in various locations in this publication. Information which is highlighted by one of these notations must be observed to help minimize risk of personal injury or possible improper installation which may render the vehicle unsafe. Notes are used to help emphasize areas of procedural importance and provide helpful suggestions. The following definitions explain the use of these notations as they appear throughout this guide.

DANGER

INDICATES IMMEDIATE HAZARDS WHICH WILL RESULT IN SEVERE PERSONAL INJURY OR DEATH.

WARNING

INDICATES HAZARDS OR UNSAFE PRACTICES WHICH COULD RESULT IN SEVERE PERSONAL INJURY OR DEATH.

CAUTION

INDICATES HAZARDS OR UNSAFE PRACTICES WHICH COULD RESULT IN DAMAGE TO THE MACHINE OR MINOR PERSONAL INJURY.

NOTE

Indicates a procedure, practice or hint which is important to highlight.

IMPORTANT SAFETY NOTICES

The installation of this kit does not alter the Gross Vehicle Weight Rating (GVWR) or payload of the vehicle. Check your vehicle's owner's manual and do not exceed the maximum load listed for your vehicle.

Gross Vehicle Weight Rating: The maximum allowable weight of the fully loaded vehicle (including passengers and cargo). This number — along with other weight limits, as well as tire, rim size and inflation pressure data — is shown on the vehicle's Safety Compliance Certification Label.

Payload: The combined, maximum allowable weight of cargo and passengers that the vehicle is designed to carry. Payload is GVWR minus the Base Curb Weight.

WARNING

DO NOT INFLATE AIR SPRINGS WHILE OFF OF THE VEHICLE. DAMAGE TO ASSEMBLY MAY RESULT AND VOID WARRANTY.

CAUTION

DO NOT WELD TO, OR MODIFY PERFORMANCE STRUTS/SHOCKS IN ANY WAY. DAMAGE TO UNIT MAY OCCUR AND WILL VOID WARRANTY.

Installation Diagram

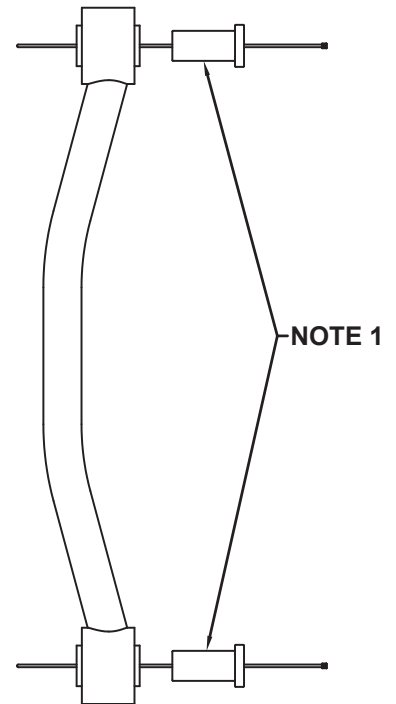
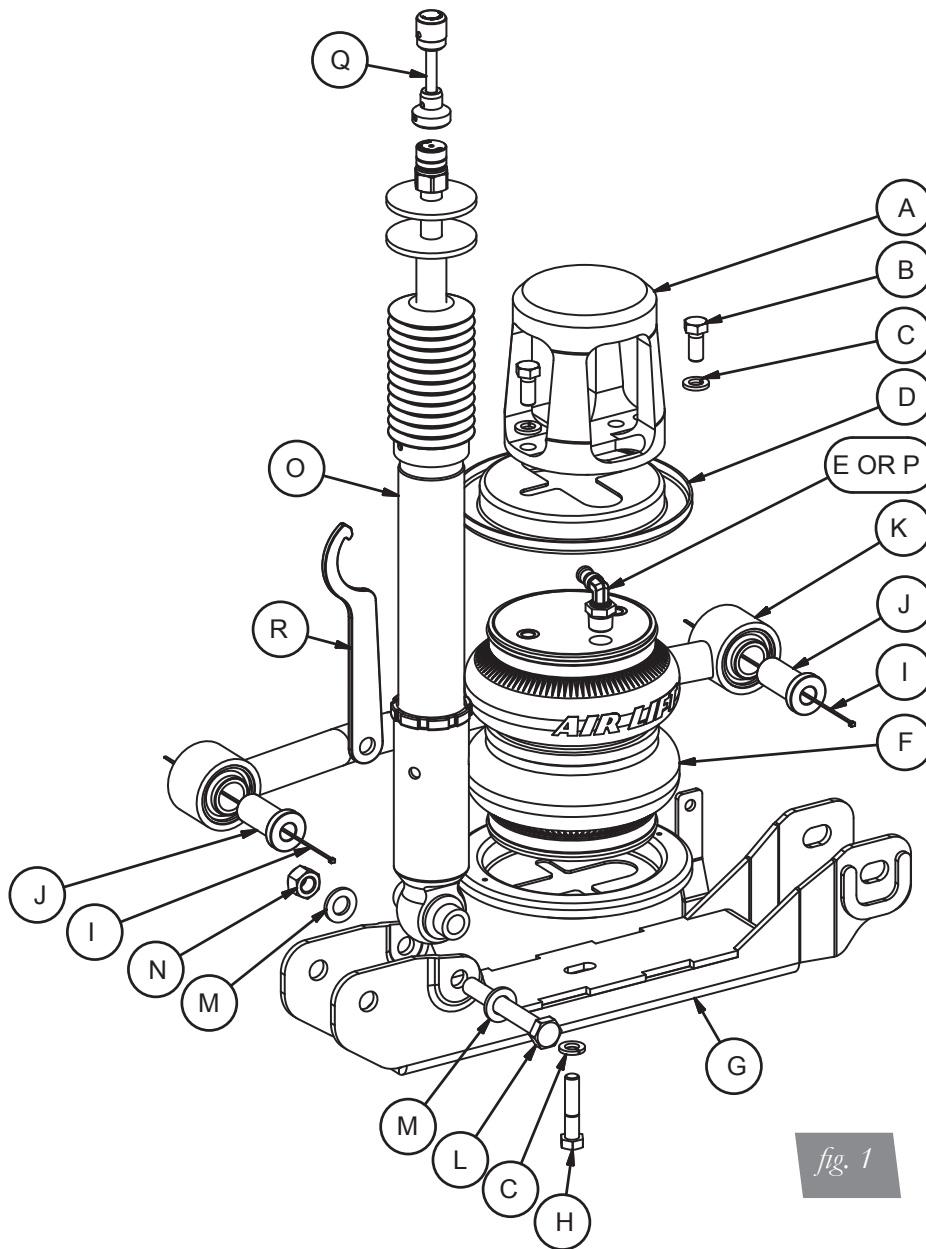

NOTE:

- 1) Remove the zip ties that hold the bushing spacers into the toe link before installation. The shoulder of the spacer is to be opposite the bend for air spring clearance purposes.
- 2) Shock, adjuster extension and wrench may not be included depending on the kit purchased.

fig. 1

HARDWARE LIST

Item	Part #	Description	Qty	Item	Part #	Description	Qty
A	13314	Rear Upper Bracket	2	J	13988	Bushing, 20mm	4
B	17203	3/8"-24 X 7/8" Hex Bolt	4	K	11127	Toe Link	2
C	18427	3/8" Lock Washer	6	L	17488	M12-1.75 X 90 Hex Cap Screw	2
D	11801	Roll Plate	4	M	18547	Flat Washer	4
E	21846	3/8"MNPT X 1/4"PTC, 90°	2	N	18546	Nyloc Nut	2
F	58530	Air Spring	2	O	26749	Rear Shock, BMW E8X/E9X	2
G	11126	Control Arm, Rear	2	P	21867	3/8"MNPT X 3/8"PTC	1
H	17484	3/8-24 X 1.75" Hex Cap Screw	2	Q		Flex Adjuster Extension	2
I	10466	8" Zip Tie	4	R		Spanner Wrench	1



Missing or damaged parts? Call Air Lift customer service at (800) 248-0892 for a replacement part.

Installing the Air Suspension

PREPARING THE VEHICLE

1. Elevate and support the vehicle with a hoist or jack stands.
2. Remove the rear tire and support the hub assembly (fig. 2).

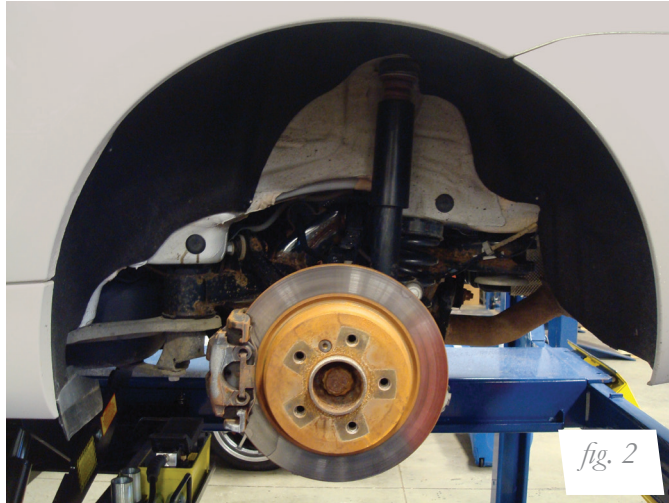

3. Disconnect the headlight alignment linkage from the lower control arm bracket (if equipped) (fig. 3).



REMOVING THE REAR SUSPENSION

1. Remove the coil spring and rubber spring isolator from the top spring seat (fig. 4).
COIL SPRING UNDER COMPRESSION. COIL SPRINGS SHOULD BE REMOVED USING FACTORY PRESCRIBED GUIDELINES.

CAUTION

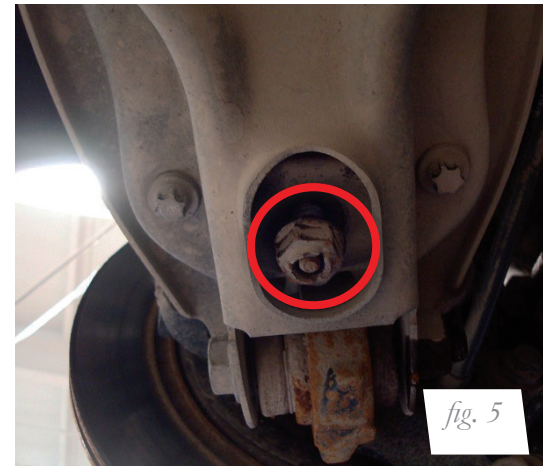
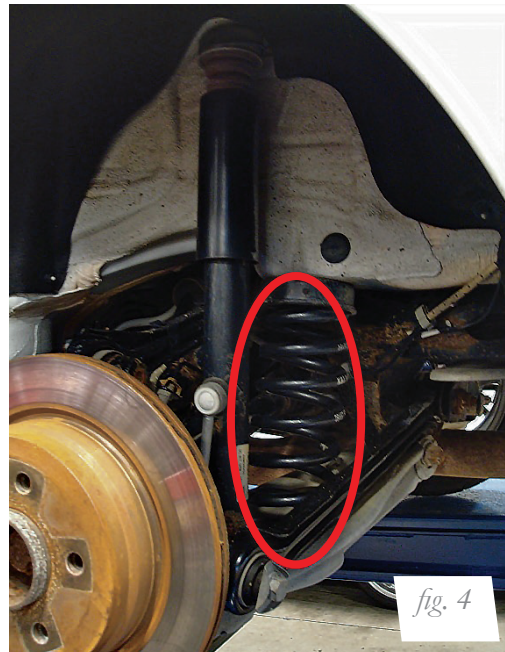

2. Disconnect the lower shock nut from the isolated mount (fig. 5).
3. Support the lower control arm and unbolt the lower control arm from the hub assembly and sub-frame (fig. 6). Remove the lower control arm.

NOTE

Some factory exhaust pieces may need to be removed or lowered to remove the cam bolt that attaches the lower control arm to the sub-frame.

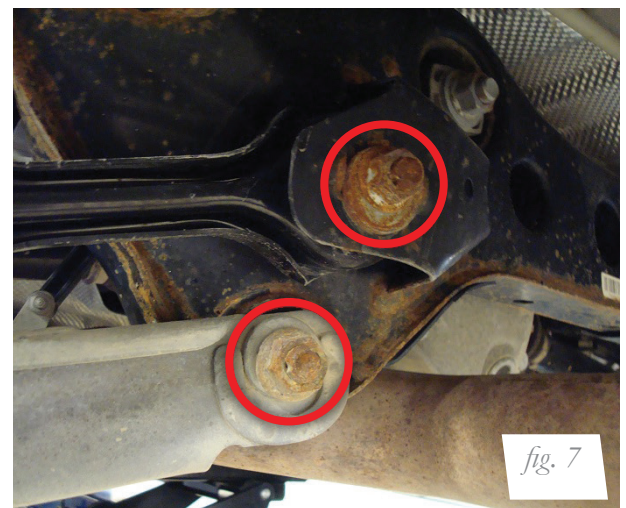
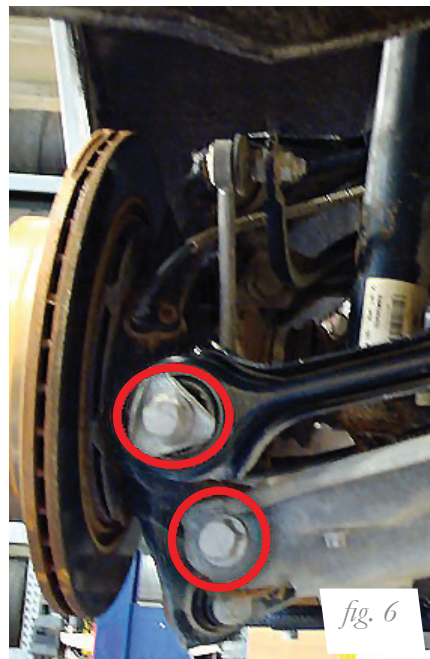

4. Unbolt and remove the toe link from the hub and sub-frame (fig. 7).

5. Within the trunk, remove the shock rod nut and remove the shock from the vehicle (fig. 8). Retain the lower isolator and rubber gasket that the shock rod passes through within the wheel housing (fig. 9).



6. If installing the kit without rear shocks, proceed to the “Assembling the Air Spring Upper Bracket and Air Fitting” section. With the rod nut removed (fig. 10), peel the micro cellular isolator from the rod nut washer and retain this isolator for future use (figs. 11 and 12). Take care not to damage the isolator during the removal process. The nut and washer will not be used when installing Air Lift rear shocks.



ASSEMBLING THE AIR SPRING UPPER BRACKET AND AIR FITTING

1. Apply thread sealant to the chosen air fitting threads and install into the air spring port. Torque 1 and 3/4 turns beyond hand tight.
2. Place the roll plate over the air spring followed by the upper mount spacer (fig. 13). Attach with two bolts and lock washers. Torque to 27 Nm (20 ft-lbs.) There are two mounting positions for the upper spacer to mount to the air spring. Best practice is to have the air fitting located on the forward side the vehicle, with the air line outlet facing rearward. This helps protect the air line connection. Mount the air spring so that it is positioned away from the wheel, toward the cross-member (fig. 14).

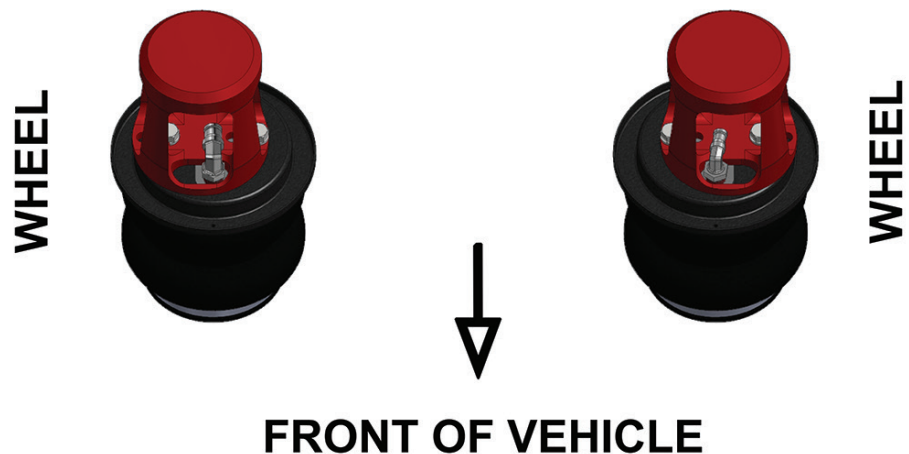
*fig. 13**fig. 14*

INSTALLING THE AIR SUSPENSION

1. Attach the supplied lower control arm to the hub assembly and the sub-frame (figs. 15 and 16). Do not torque bolts at this time.



2. Attach the headlight alignment linkage to the control arm (fig. 17).



3. Place the air spring assembly with the remaining roll plate on the lower control arm (fig. 18). Bolt the air spring in place by assembling a lock washer and bolt (H) through the control arm. Torque to 27 Nm (20 ft-lbs.) The upper mount is offset to properly position the air spring in the chassis (fig. 19). Align the assembly so the air spring is closest to the sub-frame. The air spring must be positioned furthest inboard away from the shock and wheel. Then insert the air spring spacer into the coil spring perch.

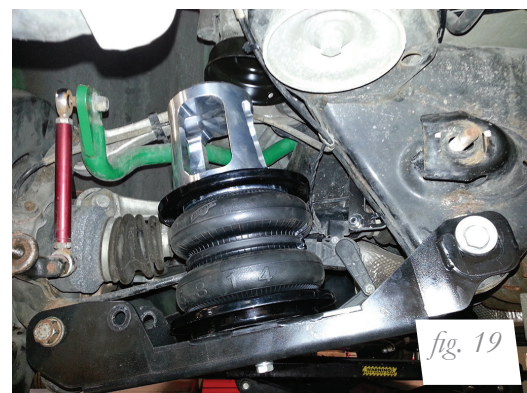

4. Snip the zip ties from the toe link. The toe link bushing spacers must be installed opposite the bend of the link (fig. 20). Attach the link to the hub assembly and sub-frame with the bend rearward and directed downward (figs. 21 and 22). Do not torque bolts at this time.

CAUTION

IF THE BEND IS DIRECTED UPWARD, CONTACT WITH THE SUB-FRAME AND TOE LINK WILL OCCUR. IF THE BEND IS FORWARD OR IF THE BUSHING SPACERS ARE INSTALLED INCORRECTLY, AIR SPRING CONTACT WITH THE TOE LINK WILL OCCUR. THIS CONTACT WILL CAUSE DEGRADATION OF THE AIR SPRING AND VOID THE WARRANTY.

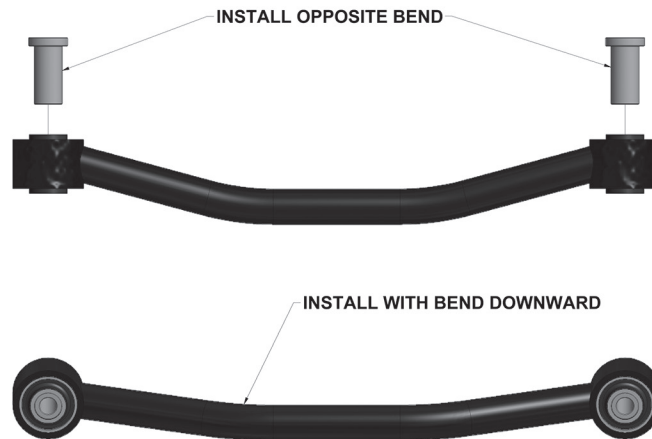

fig. 20



INSTALLING SHOCKS

NOTE

When purchasing kit 78609 without rear shocks, you must acquire BMW E9X M3 shocks because of the way the shock mounts to the lower control arm. Standard E8X/E9X rear shocks will not work with this kit.

1. Insert the shock rod with large washer through the lower isolator and gasket (fig. 23). Install through the upper shock mount (fig. 24). Within the trunk, apply the upper isolator (fig. 25) followed by the second large flat washer (fig. 26) and nyloc nut (fig. 27). Torque the nyloc nut to 27Nm (20lbs ft).



2. Align the lower shock eye with the control arm shock mount and install the supplied bolt and washer (fig. 28). Apply another washer, and nyloc nut to the other side (fig. 29). Do not torque at this time.

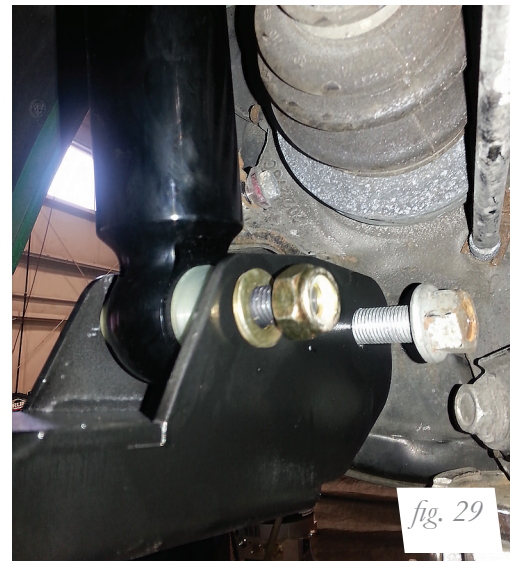

3. Fully compress the suspension using a jack. With the suspension compressed, review the best routing for the air line that is clear of all suspension components and axle. Routing should also allow for the suspension to extend without kinking or pulling the line tight or rubbing on other components. Check clearances to all other components.

4. With the suspension fully compressed, take a measurement from the fender to some reference point – typically the center of the axle. Record this measurement as Max Compression.
5. Cycle the suspension to Max Extension and record the measurement from the same reference points.
6. Add ME and MC then divide by 2. Set the suspension to this point. This position will give 50% stroke in either direction and is a starting point for ride height (fig. 30).

Formula for Calculating Ride Height

$$(ME+MC) \div 2 = \text{MID STROKE}$$

fig. 30

7. With the suspension at this position, loosen, then re-torque the lower control arm bolts to manufacturer's specifications (Table 1).

Torque Specifications			
Location	Nm	lb-ft	lb-in
Toe Link to Sub Frame	100	74	
Toe Link to Hub	100	74	
Lower Control Arm to Sub Frame	165	122	
Lower Control Arm to Hub	165	122	
Trailing Arm to Sub Frame	100	74	
Trailing Arm to Hub	100 + 90°	74 + 90°	
Wishbone to Sub Frame	100	74	
Wishbone to Hub	100 + 90°	74 + 90°	
Shock Rod Nyloc Nut	27	20	
Shock Eye Nut/Bolt	132	97	
Headlight Alignment Nut	5		44
Air spring bolts	27	20	
Wheels	120	89	
Air Fitting (with sealant)	1.5-3.0 turns beyond hand tight		

Table 1

DAMPING ADJUSTMENT

The struts in this kit have 30 settings, or “clicks”, of adjustable compression and rebound damping characteristics. Damping is changed through the strut rod using the supplied adjuster (figs. 31 & 32) or a 3mm allen wrench.

Turn the adjuster clockwise and the damping settings are hardened. Turn the adjuster counterclockwise and the damping is softened.

Each shock is preset to “-20 clicks”. This means that the shock is adjusted 20 clicks away from full stiff. Counting down from full stiff is the preferred method of keeping track of, or setting, damping. This setting was developed on a BMW 135i and may need to be adjusted to different vehicles and driving characteristics.

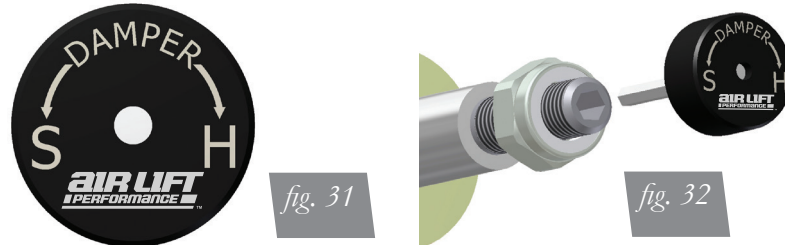

ALIGNING THE VEHICLE

1. Using the control system, set the vehicle height to the new custom ride height.
2. If the custom ride height is lower than stock, we recommend loosening all pivot points (bolts, nuts) on any control arm, strut arm or radius rod that contains bushings. Once they have been loosened, re-torque to stock specifications.

NOTE

It may be necessary to cycle the suspension to loosen the bushing up from its mount. This will help re-orient the bushing at its new position based on the custom ride height.

ADJUSTING EXTENDED OR DROP HEIGHT USING LOWER MOUNT

Your dampers have been pre-set at the factory to provide maximum drop height while maintaining adequate tire clearance to the air spring. If you wish to gain more extended height (lift), which is the same as reducing drop height, or want to lower the chassis further and there is still adjustment available at the lower mount, please use the following procedure:

1. Support the vehicle with jack stands or a hoist at approved lifting points.
2. Remove the wheel.
3. Using the supplied spanner wrench, loosen the lower locking collar (fig. 33).

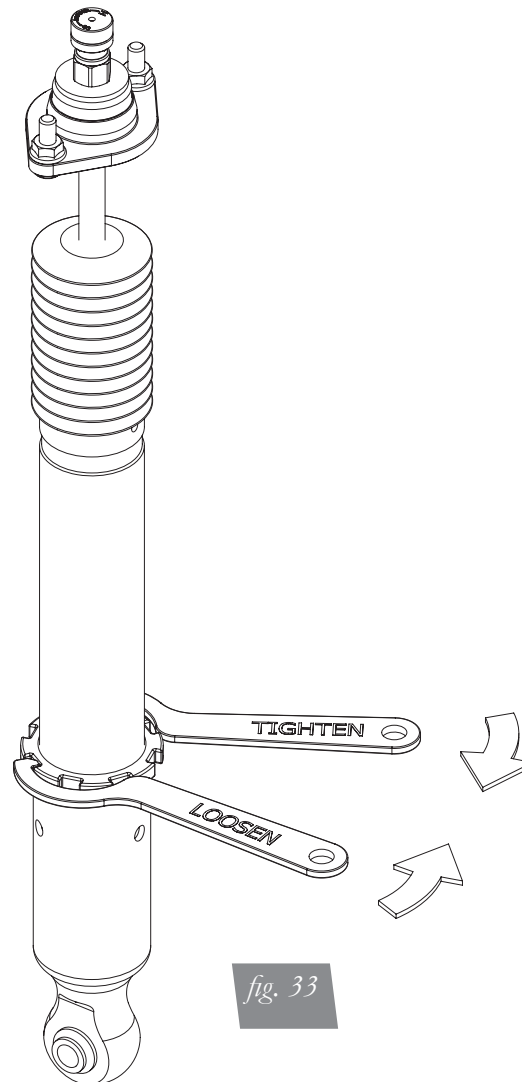

4. Deflate the air spring to 0 PSI on the corner you are adjusting.
5. Disconnect lower mount from suspension.
6. Spin the lower mount to the desired location.

NOTE

Not all models will have further drop height available.

7. Re-install lower mount to suspension and torque fasteners.
8. Tighten the lower locking collar to the lower mount using significant force.

CAUTION

WHEN ADJUSTING HEIGHT UPWARDS, MAKE SURE THAT THE DAMPER BODY ENGAGES ALL THE THREADS OF THE LOWER MOUNT (FIG. 34). WHEN ADJUSTING DOWNWARDS, MAKE SURE THERE IS ADEQUATE AIR SPRING CLEARANCE TO THE TIRE/WHEEL ASSEMBLY. CLEARANCE MUST BE CHECKED WITH SYSTEM FULLY DEFLATED AS WELL AS FULLY INFLATED TO ENSURE THAT NO RUBBING OCCURS. FAILURE TO MAINTAIN ADEQUATE CLEARANCE CAN RESULT IN AIR SPRING FAILURE AND WILL NOT BE COVERED UNDER WARRANTY.

CAUTION

DO NOT ADJUST HEIGHT BY SPINNING AIR SPRING ON DAMPER! DOING SO MAY CAUSE AN AIR LEAK AND COMPROMISE THE ASSEMBLY.

FOR STRUTS:

FOR SHOCKS:

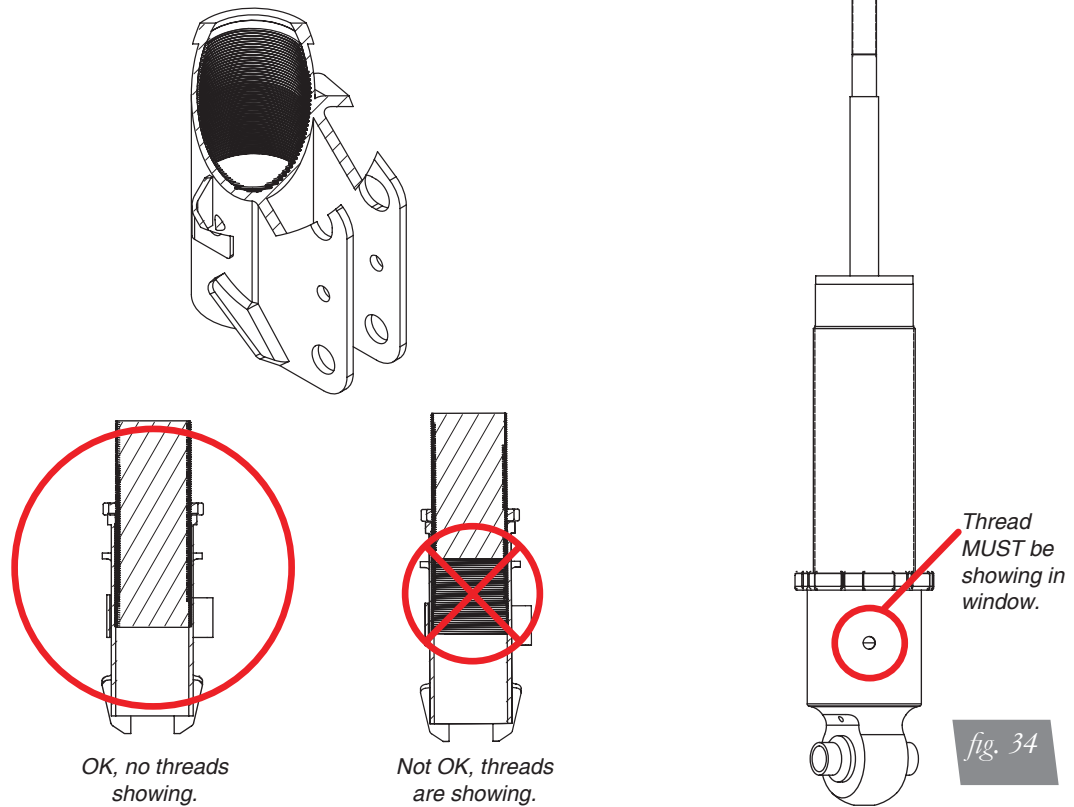

Before Operating

CAUTION

MAKE SURE THE FRONT WHEELS ARE STRAIGHT WHEN DEFLATING AND REINFLATING AIR BAGS.

1. Inflate and deflate the system (do not exceed 125 PSI) to check for clearance or binding issues. With the air springs deflated, check clearances on everything so as not to pinch brake lines, vent tubes, etc. Clear lines if necessary.
2. Inflate the air springs to 75-90 PSI and check all connections for leaks.
3. Air Lift part #27669 or #27671, AutoPilot V2 Air Management System, is highly recommended for this product.
4. Please familiarize yourself further with this product by reading the Product Use, Maintenance and Servicing section.

INSTALLATION CHECKLIST

- Clearance test — Inflate the air springs to 75-90 PSI and make sure there is at least ½” clearance from anything that might rub against each sleeve. Be sure to check the tire, brake drum, frame, shock absorbers and brake cables.
- Leak test before road test — Inflate the air springs to 75-90 PSI and check all connections for leaks. All leaks must be eliminated before the vehicle is road tested.
- Heat test — Be sure there is sufficient clearance from heat sources, at least 6” for air springs and air lines. If a heat shield was included in the kit, install it. If there is no heat shield, but one is required, call Air Lift customer service at (800) 248-0892.
- Fastener test — Recheck all bolts for proper torque.
- Road test — The vehicle should be road tested after the preceding tests. Inflate the springs to recommended driving pressures. Drive the vehicle 10 miles and recheck for clearance, loose fasteners and air leaks.
- Operating instructions — If professionally installed, the installer should review the operating instructions with the owner. Be sure to provide the owner with all of the paperwork that came with the kit.

Technician's Signature _____

Date _____

POST-INSTALLATION CHECKLIST

- Overnight leak down test — Recheck air pressure after the vehicle has been used for 24 hours. If the pressure has dropped more than 5 PSI, then there is a leak that must be fixed. Either fix the leak yourself or return to the installer for service.
- Air pressure requirements — Regardless of load, the air pressure should always be adjusted to maintain adequate ride height at all times while driving.
- Thirty day or 500 mile test — Recheck the air spring system after 30 days or 500 miles, whichever comes first. If any part shows signs of rubbing or abrasion, the source should be identified and moved, if possible. If it is not possible to relocate the cause of the abrasion, the air spring may need to be remounted. If professionally installed, the installer should be consulted. Check all fasteners for tightness.

Product Use, Maintenance and Servicing

Suggested Driving Air Pressure	Maximum Air Pressure
70 PSI	125 PSI
FAILURE TO MAINTAIN ADEQUATE MINIMUM PRESSURE (OR PRESSURE PROPORTIONAL TO LOAD) WILL RESULT IN BOTTOMING OUT, OVER-EXTENSION OR RUBBING AGAINST ANOTHER COMPONENT AND WILL VOID THE WARRANTY.	

MAINTENANCE GUIDELINES

NOTE

By following these steps, vehicle owners will obtain the longest life and best results from their air spring.

1. Check the air pressure before driving.
2. Never inflate beyond 125 PSI.
3. If you develop an air leak in the system, use a soapy water solution to check all air line connections, before deflating and removing the spring.
4. When increasing load, always adjust the air pressure to maintain normal ride height. Increase or decrease pressure from the system as necessary to attain normal ride height for optimal ride and handling. Remember that loads carried behind the axle (including tongue loads) require more leveling force (pressure) than those carried directly over the axle.

CAUTION

FOR YOUR SAFETY AND TO PREVENT DAMAGE TO YOUR VEHICLE, DO NOT EXCEED MAXIMUM GROSS VEHICLE WEIGHT RATING (GVWR), AS INDICATED BY THE VEHICLE MANUFACTURER. ALTHOUGH YOUR AIR SPRINGS ARE RATED AT A MAXIMUM INFLATION PRESSURE OF 125 PSI, THE AIR PRESSURE ACTUALLY NEEDED IS DEPENDENT ON YOUR LOAD.

5. Always add air to the springs in small quantities, checking the pressure frequently. Sleeves require less air volume than a tire and inflate quickly.
6. Should it become necessary to raise the vehicle by the frame, make sure the control system is turned off before lifting.

Troubleshooting Guide

1. Leak test the air line connections, the threaded connection into the air spring, and all fittings in the control system.
2. Inspect the air lines to be sure none are pinched. Tie straps may be too tight. Loosen or replace the strap and replace leaking components.
3. Inspect the air line for holes and cracks. Replace as needed.
4. Look for a kink or fold in the air line. Reroute as needed.

If the preceding steps do not solve the problem, it is possibly caused by a failed air spring — either a factory defect or an operating problem. Please call Air Lift at (800) 248-0892 for assistance.

Frequently Asked Questions

Q. Will installing air springs increase the weight ratings of a vehicle?

No. Adding air springs will not change the weight ratings (GAWR, GCWR and/or GVWR) of a vehicle. Exceeding the GVWR is dangerous and voids the Air Lift warranty.

Q. How long should air springs last?

If the air springs are properly installed and maintained they can last indefinitely.

Q. Will raising the vehicle on a hoist for service work damage the air springs?

No. The vehicle can be lifted on a hoist for short-term service work such as tire rotation or oil changes. However, if the vehicle will be on the hoist for a prolonged period of time, support the axle with jack stands in order to take the tension off of the air springs.

Tuning the Air Pressure

Pressure determination comes down to three things — level vehicle, ride comfort, and stability.

1. Level vehicle

If the vehicle's headlights are shining into the trees or the vehicle is leaning to one side, then it is not level. Raise the air pressure to correct either of these problems and level the vehicle.

2. Ride comfort

If the vehicle has a rough or harsh ride it may be due to either too much pressure or not enough. Try different pressures to determine the best ride comfort. See Air Lift suggested driving air pressure.

3. Stability

Stability translates into safety and should be the priority, meaning the driver may need to sacrifice a perfectly level and comfortable ride. Stability issues include roll control, bounce, dive during braking and sponginess. Tuning out these problems usually requires additional air pressure, strut damping, or both.

Checking for leaks

1. Inflate the air spring to 80 PSI.
2. Spray all connections and the inflation valves with a solution of 1/5 liquid dish soap and 4/5 water. Spot leaks easily by looking for bubbles in the soapy water.
3. After the test, deflate the springs to the minimum pressure required to restore the system to normal ride height.
4. Check the air pressure again after 24 hours. A 2-4 PSI loss after initial installation is normal. Retest for leaks if the loss is more than 5 PSI.

Fixing Leaks

1. If there is a problem with a swivel fitting:
 - a. Check the air line connection by deflating the spring and removing the line by pulling the collar against the fitting and pulling firmly on the air line. Trim 1" off the end of the air line. Be sure the cut is clean and square (see fig. 35). Reinsert the air line into the push-to-connect fitting.
 - b. Check the threaded connection by tightening the swivel fitting another ½ turn. If it still leaks, deflate the air spring, remove the fitting, and re-coat the threads with thread sealant. Reinstall by hand tightening as much as possible and then use a wrench for an additional two turns.
2. If the preceding steps have not resolved the problem, call Air Lift customer service at (800) 248-0892.

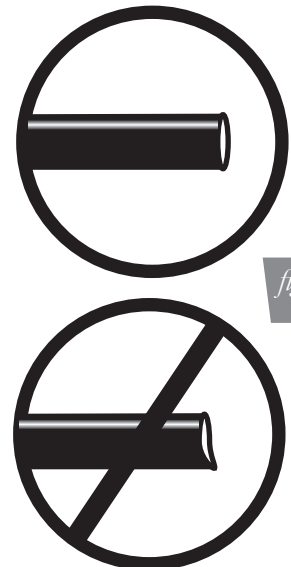

fig. 35

Warranty and Returns Policy

Air Lift Performance warrants its performance products for one year to the original purchaser against manufacturing defects one year from the date of purchase when used on cars and trucks as specified under normal operating conditions. The warranty does not apply to products that have been improperly applied, improperly installed, or which have not been maintained in accordance with installation instructions furnished with all products. The consumer will be responsible for removing (labor charges) the defective product from the vehicle and returning it, transportation costs prepaid, to the dealer from which it was purchased or to Air Lift Performance for verification.

Air Lift will repair or replace, at its option, defective products or components. A minimum \$10.00 shipping and handling charge will apply to all warranty claims. Before returning any defective product, you must call Air Lift at (800) 248-0892 in the U.S. and Canada (elsewhere, (517) 322-2144) for a Returned Materials Authorization (RMA) number. Returns to Air Lift can be sent to: Air Lift Performance • 2727 Snow Road • Lansing, MI • 48917.

Product failures resulting from abnormal use or misuse are excluded from this warranty. The loss of use of the product, loss of time, inconvenience, commercial loss or consequential damages is not covered. The consumer is responsible for installation/reinstallation (labor charges) of the product. Air Lift Performance reserves the right to change the design of any product without assuming any obligation to modify any product previously manufactured.

This warranty gives you specific legal rights and you may also have other rights that may vary from state-to-state. Some states do not allow limitations on how long an implied warranty lasts or allow the exclusion or limitation of incidental or consequential damages. The above limitation or exclusion may not apply to you. There are no warranties, expressed or implied including any implied warranties of merchantability and fitness, which extend beyond this warranty period. There are no warranties that extend beyond the description on the face hereof. Seller disclaims the implied warranty of merchantability. (Dated proof of purchase required.)

Replacement Information

If you need replacement parts, contact the local dealer or call Air Lift customer service at (800) 248-0892. Most parts are immediately available and can be shipped the same day.

Contact Air Lift Performance customer service at (800) 248-0892 first if:

- Parts are missing from the kit.
- Need technical assistance on installation or operation.
- Broken or defective parts in the kit.
- Wrong parts in the kit.
- Have a warranty claim or question.

Contact the retailer where the kit was purchased:

- If it is necessary to return or exchange the kit for any reason.
- If there is a problem with shipping if shipped from the retailer.
- If there is a problem with the price.

Contact Information

If you have any questions, comments or need technical assistance contact our customer service department by calling (800) 248-0892. For calls from outside the USA or Canada, our local number is (517) 322-2144. You may also contact customer service anytime by e-mail at techsupport@airliftperformance.com.

For inquiries by mail, our address is PO Box 80167, Lansing, MI 48908-0167. Our shipping address for returns is 2727 Snow Road, Lansing, MI 48917.

You may also contact our sales team anytime by e-mail at sales@airliftperformance.com or on the web at www.airliftperformance.com.

Notes

Notes

Need Help?

Contact our customer service department by calling (800) 248-0892. For calls from outside the USA or Canada, our local number is (517) 322-2144.



Thank you for purchasing Air Lift Performance products!

Air Lift Performance • 2727 Snow Road • Lansing, MI 48917 or PO Box 80167 • Lansing, MI 48908-0167
Toll Free (800) 248-0892 • Local (517) 322-2144 • Fax (517) 322-0240 • www.airliftperformance.com

Printed in
the USA