

# LoadLIFTER™ 5000

by AIR LIFT®

## Kit 57257 Dodge 1500 2-Wheel Drive



### INSTALLATION GUIDE

For maximum effectiveness and safety, please read these instructions completely before proceeding with installation.

*Failure to read these instructions can result in an incorrect installation.*



# TABLE OF CONTENTS

<b>Introduction</b> . . . . .	<b>2</b>
Important Safety Notice . . . . .	2
Notation Explanation . . . . .	2
<b>Installation Diagram</b> . . . . .	<b>3</b>
<b>Hardware and Tools Lists</b> . . . . .	<b>4</b>
<b>Installing the LoadLifter 5000 System</b> . . . . .	<b>5</b>
Getting Started . . . . .	5
Tech Tip Option . . . . .	6
Assembling the Air Spring Assemblies . . . . .	7
Attaching the Upper Brackets . . . . .	9
Attaching the Lower Brackets . . . . .	9
Heat Shield Installation . . . . .	11
Views of the Installed Assembly . . . . .	12
Installing the Air Lines . . . . .	14
Checking for Leaks . . . . .	15
Fixing Leaks . . . . .	15
<b>Before Operating</b> . . . . .	<b>16</b>
Installation Checklist . . . . .	16
Post-Installation Checklist . . . . .	16
<b>Product Use, Maintenance and Servicing</b> . . . . .	<b>17</b>
Minimum and Maximum Pressure . . . . .	17
Maintenance Guidelines . . . . .	17
Troubleshooting Guide . . . . .	17
Frequently Asked Questions . . . . .	18
Tuning the Air Pressure . . . . .	18
Guidelines for Adding Air . . . . .	19
<b>Choosing the Right On-Board Air Compressor System</b> . . . . .	<b>20</b>
<b>Warranty and Returns Policy</b> . . . . .	<b>21</b>
<b>Replacement Information</b> . . . . .	<b>22</b>
<b>Contact Information</b> . . . . .	<b>22</b>

# Introduction

The purpose of this publication is to assist with the installation, maintenance and troubleshooting of the LoadLifter 5000 air spring kit. LoadLifter 5000 utilizes sturdy, reinforced, commercial grade single or double, depending on the kit, convolute bellows. The bellows are manufactured like a tire with layers of rubber and cords that control growth. LoadLifter 5000 kits are recommended for most 3/4 and 1 ton pickups and SUVs with leaf springs and provide up to 5,000 lbs. of load leveling support with air adjustability from 5-100 PSI. The kits are also used in motor home rear kits and some motor home fronts where leaf spring are used.

It is important to read and understand the entire installation guide before beginning installation or performing any maintenance, service or repair. The information here includes a hardware list, tool list, step-by-step installation information, maintenance guidelines and operating tips.

Air Lift Company reserves the right to make changes and improvements to its products and publications at any time. For the latest version of this manual, contact Air Lift Company at (800) 248-0892 or visit our website at [www.airliftcompany.com](http://www.airliftcompany.com).

## IMPORTANT SAFETY NOTICE

The installation of this kit does not alter the Gross Vehicle Weight Rating (GVWR) or payload of the vehicle. Check your vehicle's owner's manual and do not exceed the maximum load listed for your vehicle.

**Gross Vehicle Weight Rating:** The maximum allowable weight of the fully loaded vehicle (including passengers and cargo). This number — along with other weight limits, as well as tire, rim size and inflation pressure data — is shown on the vehicle's Safety Compliance Certification Label.

**Payload:** The combined, maximum allowable weight of cargo and passengers that the truck is designed to carry. Payload is GVWR minus the Base Curb Weight.

## NOTATION EXPLANATION

Hazard notations appear in various locations in this publication. Information which is highlighted by one of these notations must be observed to help minimize risk of personal injury or possible improper installation which may render the vehicle unsafe. Notes are used to help emphasize areas of procedural importance and provide helpful suggestions. The following definitions explain the use of these notations as they appear throughout this guide.



### DANGER

INDICATES IMMEDIATE HAZARDS WHICH WILL RESULT IN SEVERE PERSONAL INJURY OR DEATH.



### WARNING

INDICATES HAZARDS OR UNSAFE PRACTICES WHICH COULD RESULT IN SEVERE PERSONAL INJURY OR DEATH.



### CAUTION

INDICATES HAZARDS OR UNSAFE PRACTICES WHICH COULD RESULT IN DAMAGE TO THE MACHINE OR MINOR PERSONAL INJURY.

## NOTE

*Indicates a procedure, practice or hint which is important to highlight.*

# Installation Diagram

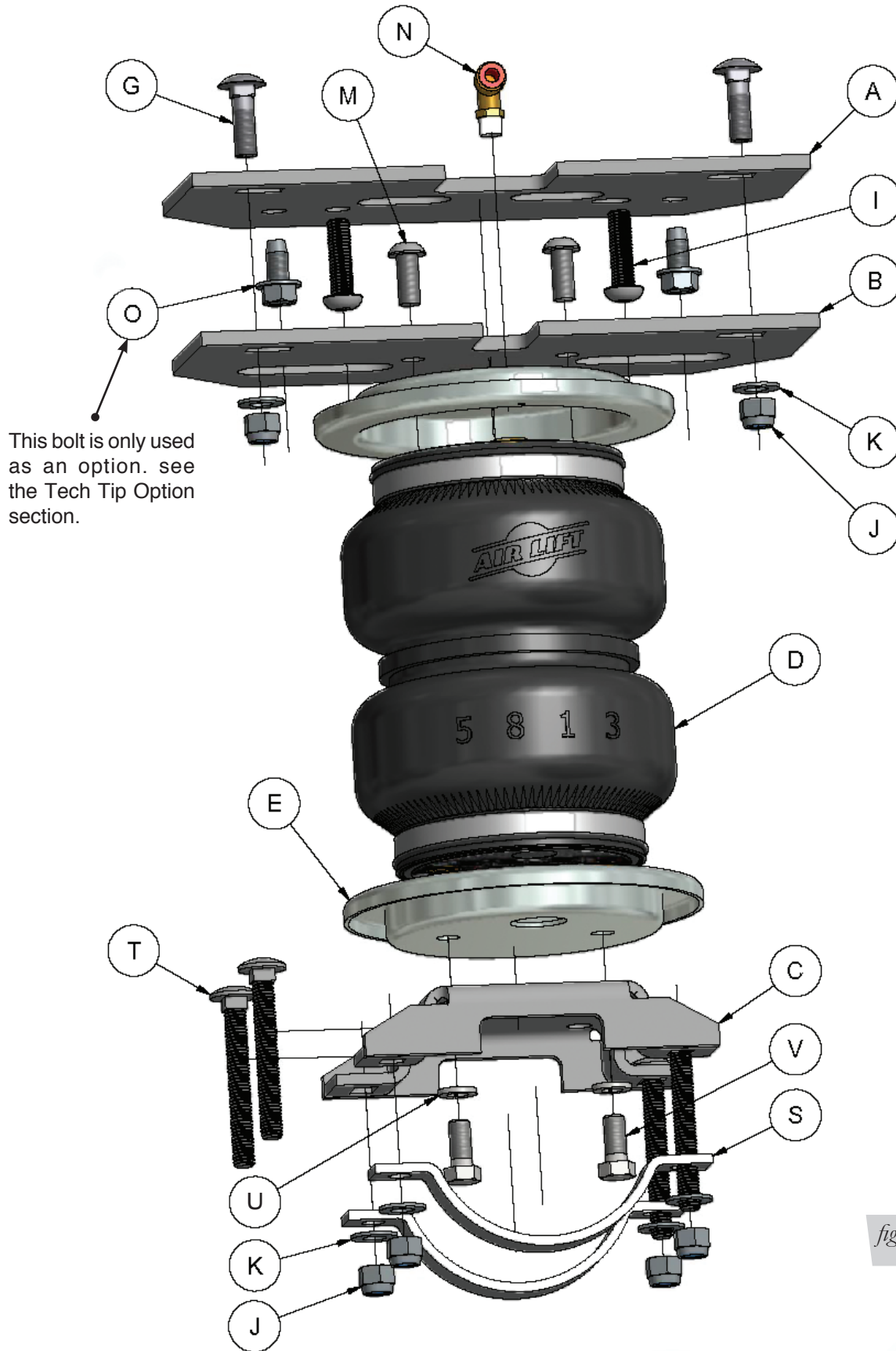

This bolt is only used as an option. see the Tech Tip Option section.

fig. 1

# Hardware and Tools Lists

## HARDWARE LIST

Item	Part #	Description.....	QTY
A	07057	Upper Frame Bracket .....	2
B	07058	Upper Bellows Bracket .....	2
C	03230	Lower Bracket.....	2
D	58437	Bellows .....	2
E	11951	Roll Plate .....	4
G	17361	3/8-16 X 1.25" Carriage Bolt.....	4
I	17366	M10-1.5 X 35 Button Head Screw .....	4
J	18435	3/8" Nyloc Nut.....	12
K	18444	3/8" Flat Washer .....	12
M	17365	3/8-24 X 7/8" Button Head Screw.....	4
N	21837	90° Swivel Fitting.....	2
O	17151	3/8 X .75" Self Tapping Bolt.....	4
S	10451	Axle Strap .....	4
T	17277	3/8-16 X 3.0" Carriage Bolt.....	8
U	18427	3/8" Lock Washer .....	4
V	17203	3/8-12 X 7/8" Hex Bolt .....	4
W	33107	Heat Shield Kit.....	1
AA	20086	Air Line Assembly.....	1
BB	10466	Tie Straps .....	6
CC	21230	Valve Cap .....	2
DD	18501	5/16" Flat Washer .....	2
EE	21234	Rubber Washer .....	2
FF	18411	Star Washer.....	2
GG	21233	5/16" Hex Nut .....	4

## TOOLS LIST

Description.....	QTY
Hoist or Floor Jacks.....	1
Safety Stands .....	2
Safety Glasses .....	1
Torque Wrench.....	1
Standard Open-end Combo Wrenches .....	1
Ratchet .....	1
Metric and Standard Sockets .....	1
#6 Metric Allen Wrench (socket if available).....	1
7/32 Allen Wrench (socket if available) .....	1
5/16 Drill Bit (very sharp) .....	1
Heavy Duty Drill.....	1
Hose Cutter, Razor Blade or Sharp Knife.....	1
Air Compressor or Compressed Air Source .....	1
Spray Bottle with Dish Soap/Water Solution .....	1



Missing or damaged parts? Call Air Lift customer service at (800) 248-0892 for a replacement part.

# Installing the LoadLifter 5000 System

## GETTING STARTED

1. Raise the vehicle and support the axle with jack stands, setting the jack stands as wide as possible on the axle (fig. 2)

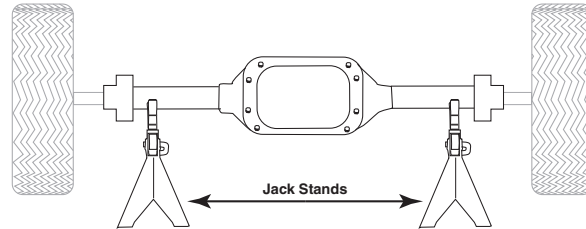

fig. 2

2. Drop the axle or raise the frame up to make room for the assemblies to be put into position between the frame and axle.
3. Remove the Jounce Bumper from under the frame rail (fig. 3).

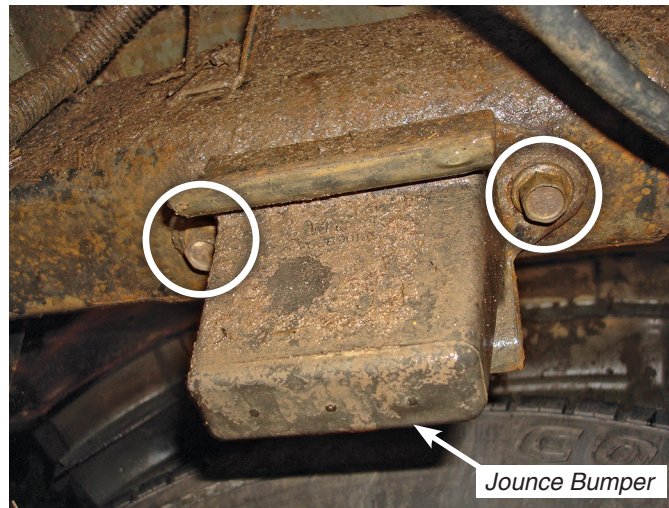

fig. 3

4. Attach the Upper Frame Bracket (A) to the frame using the two M10-1.5 X 35 Button Head Screws (I). Torque to 30ftlbs.

### NOTE

*The slot in the frame goes inboard towards the inside of the vehicle (fig. 4). Repeat for the opposite side.*

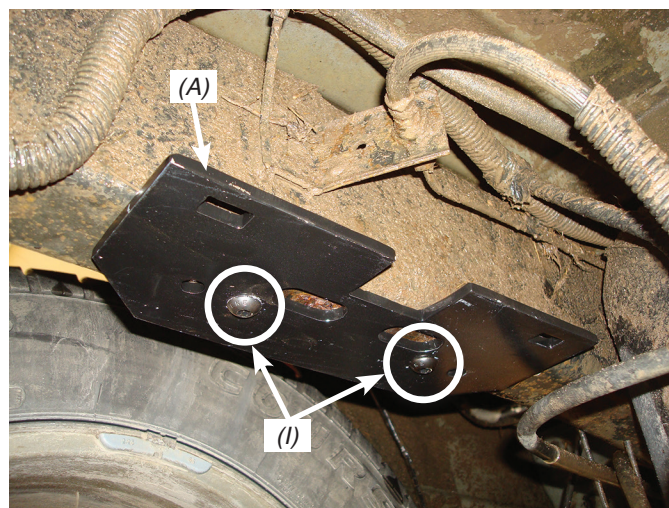

fig. 4

## TECH TIP OPTION

If by chance one of the jounce bumper bolts broke upon removal, bolt the bracket to the frame as noted above using the Jounce Bumper mounting hole the other bolt was removed from, to align the bracket.

1. Line up the hole in the upper bracket over the broken bolt (as if being bolted as stated above).
2. Center punch and drill a 5/16" hole in the center of the outside hole next to the broken bolt hole (fig. 5).

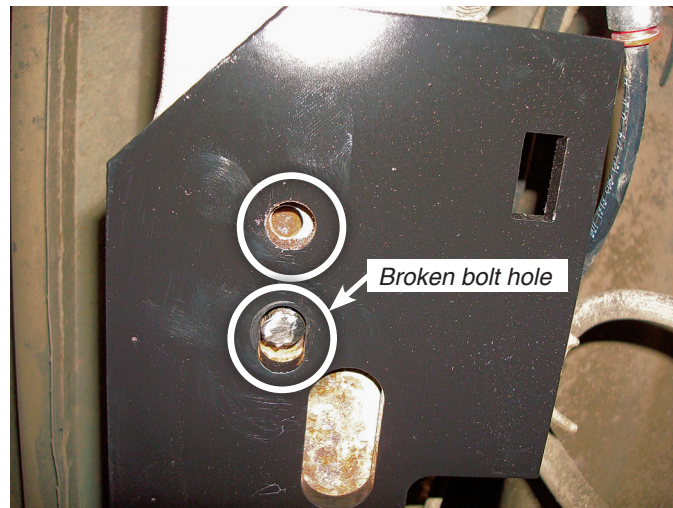

fig. 5

3. Insert and tighten a self-tapping bolt (O) into the hole drilled. Torque the bolt to 15ftlbs (fig. 6).

## NOTE

Figure 6 shows the upper bracket installed to the frame using the supplied M10 bolt (I) that was removed and a self-tapping bolt. **Use these only if the existing jounce bumper bolts break!**

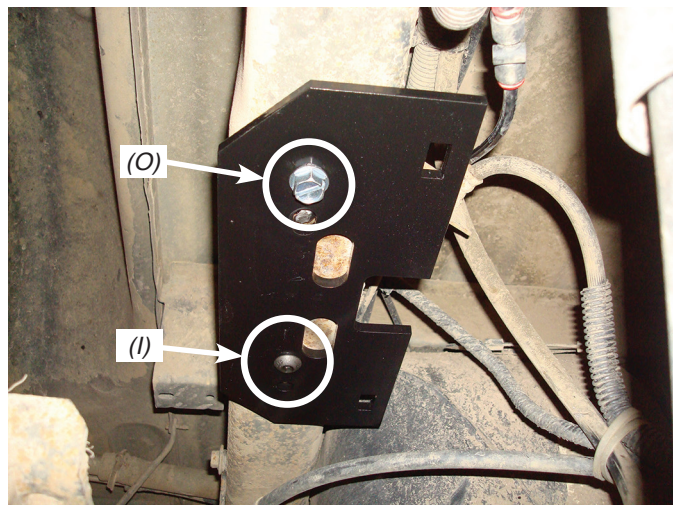

fig. 6



## ASSEMBLING THE AIR SPRING ASSEMBLIES

1. Set a roll plate (E) over the top of each air spring (D).

### NOTE

*The radiused (rounded) edge of the roll plate (E) will be towards the bellows so that the bellows is seated inside both roll plates.*

2. Install the Swivel Fitting (N) into the top of the Air Spring finger tight plus one and a half turns (fig. 7).

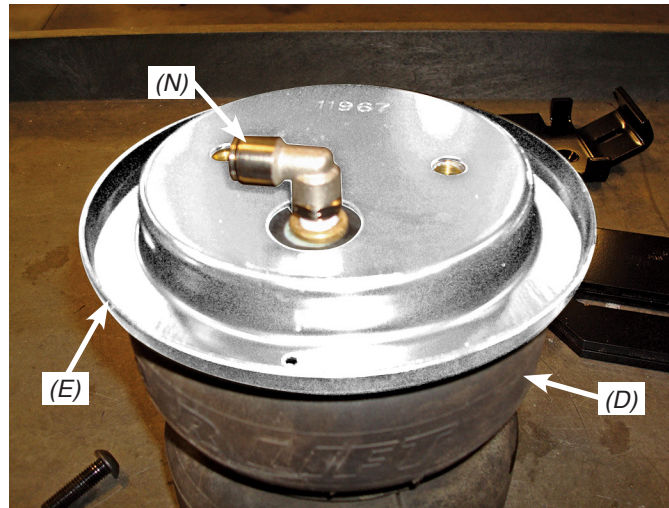

fig. 7

3. Install the Air Spring bracket (B) onto the Air Spring and attach using the 3/8 -24 X 7/8" Button Head Screws (M) (fig. 8). Torque to no more than 20ftlbs.

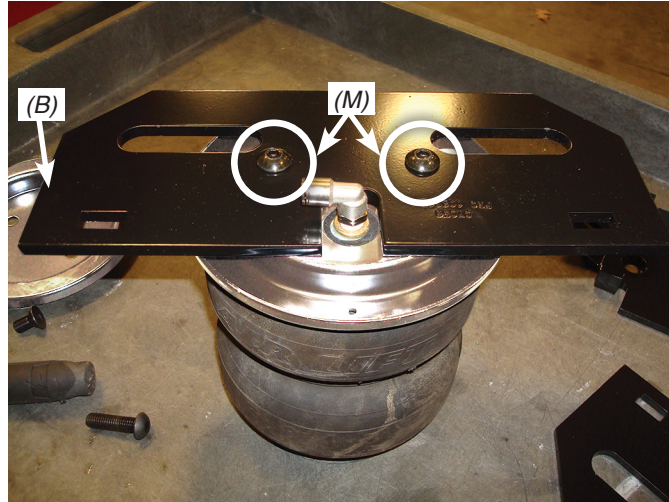
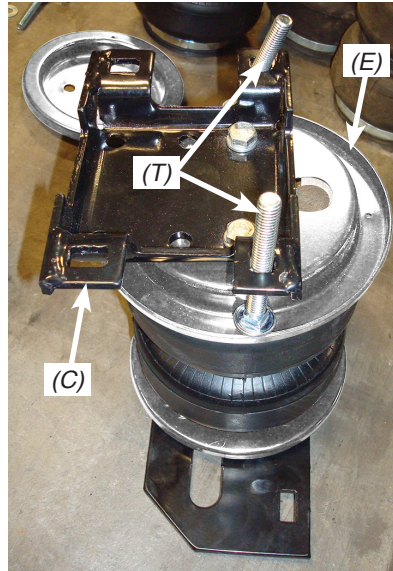
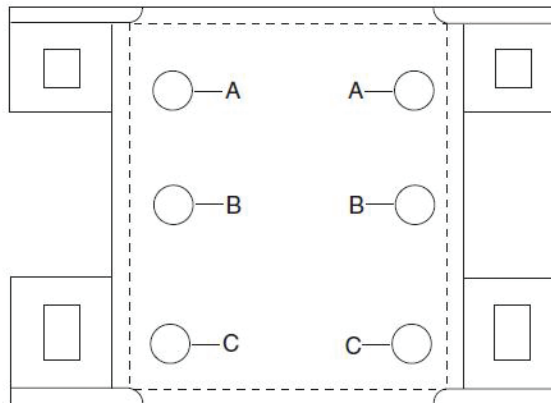

fig. 8

4. Repeat for the other assembly.

5. Flip the assemblies over; set a Roll Plate (E) onto the bottom of the Air Spring assembly (fig. 9).
6. Insert two 3/8-16 X 3.0" Carriage Bolts (T) into the lower bracket as shown and set the Lower Bracket (C) using holes "A" (fig. 10) so that the lower bracket is offset from the fitting (on the opposite (top) end of the assembly) (fig. 9). Attach the lower bracket with 3/8 Lock Washers (U) and two 3/8-24 X 3/4" Hex Bolts (V). Torque to no more than 20ftlbs.

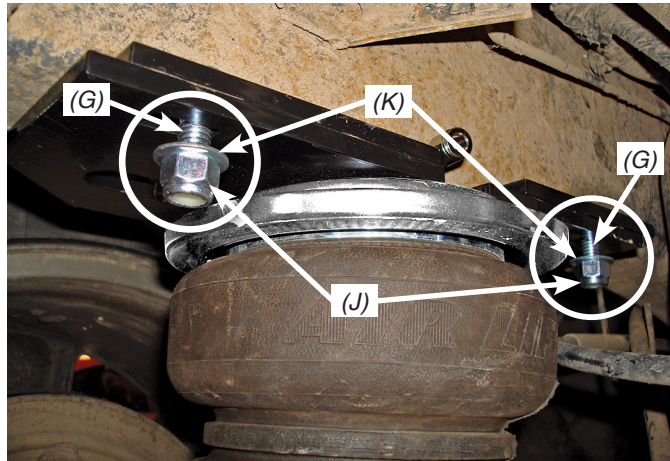

*fig. 9*

*fig. 10*

7. Figure 11 shows the finished assemblies.

*fig. 11*

## ATTACHING THE UPPER BRACKETS

1. Set the assemblies onto the axle with the fittings to the inside of the frame (fig. 12). Align the upper Air Spring and Frame bracket (A) (that was previously installed) slots and attach using two 3/8-16 X 1.25" Carriage Bolts (G), two Flat Washers (K) and two Nyloc Nuts (J). Repeat for the opposite side and leave hardware loose at this time.



*fig. 12*

## ATTACHING THE LOWER BRACKETS

1. Raise the axle or lower the frame until the lower brackets touch the axle (figs. 13 & 14).

**CAUTION**

MAKE SURE THE CARRIAGE BOLTS (T) PREVIOUSLY INSTALLED IN THE LOWER BRACKET, GO UNDER THE BRAKE LINE BEHIND THE AXLE ON THE LEFT SIDE (DRIVER SIDE) AND GO REARWARD OF THE BRAKE LINE ON THE RIGHT SIDE (PASSENGER).

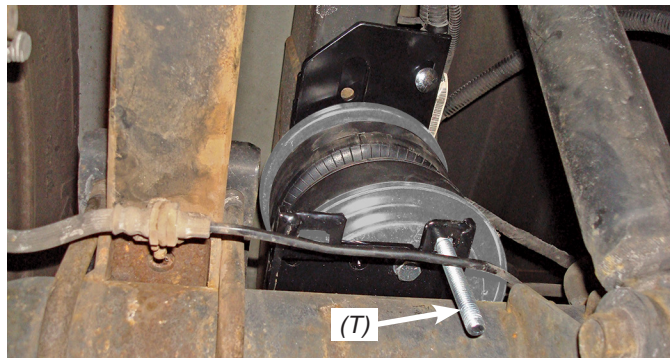

*fig. 13*

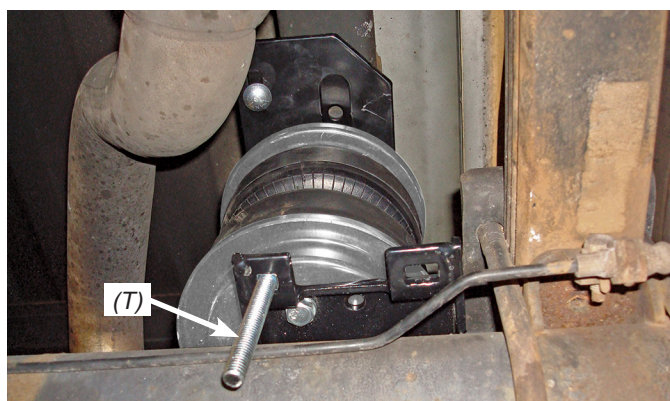
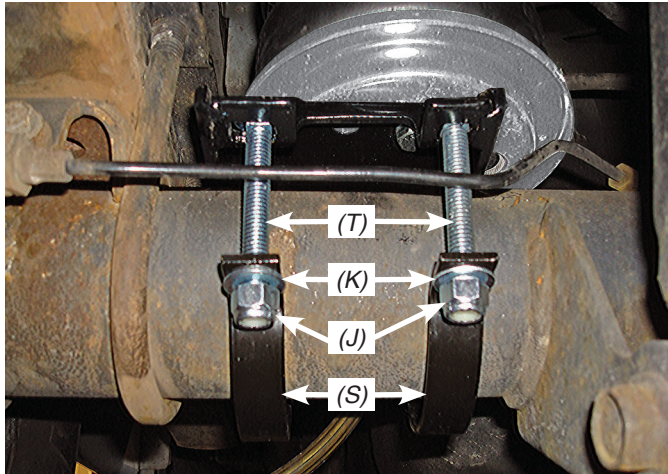

*fig. 14*

2. Insert the remaining 3/8-16 X 3.0" Carriage Bolts (T) into both lower brackets.

**NOTE**

The remaining bolts (behind the axle) will go between the brake lines and the axle (figs. 15 & 16).



**Left (driver) side lower bracket attachment shown.**

Install axle straps (S) and cap with Flat Washers (K) and Nyloc Nuts (J).

Align upper and lower brackets before torqueing.

fig. 15

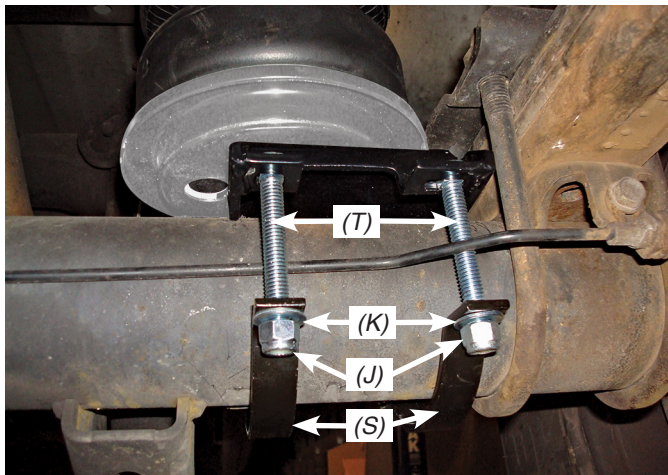

**Right (passenger) side lower bracket attachment shown.**

The inside bolt goes behind the brake line, the outside bolt goes between the brake line and axle (as shown).

fig. 16

3. Set the Axle Straps (S) over the Carriage bolts and cap with 3/8" Flat Washers (K) and 3/8" Nyloc Nuts (J).
4. With the axle raised all the way up, align the upper and lower brackets by pushing the upper bracket forward or backward. Torque the upper bracket hardware to 16ftlbs.
5. Evenly torque the lower bracket hardware to 10ftlbs.

**CAUTION**

IF THE BRAKE LINES HIT OR RUB ON THE CARRIAGE BOLTS WHEN TORQUED DOWN. SLIGHTLY ADJUST THE LINES SO THAT THERE IS A LITTLE CLEARANCE BETWEEN BOTH.

## HEAT SHIELD INSTALLATION

### NOTE

*The heat shield is installed on the exhaust pipe at the closest point to the air spring to protect the unit from the radiant heat of the exhaust system.*

1. The Hose Heat shield goes on the right side where the hose goes into the fitting on the bellows assembly.
2. Attach radiator clamps loosely around the exhaust pipe nearest to the spring.
3. Bend the heat shield tab out at a 90° angle and again half the distance up at a 90° angle to form an “L” shape (fig. 17). Repeat on the other tab. Position the heat shield and insert the heat shield tabs beneath the two radiator clamps. Tighten the clamps (Fig. 18).

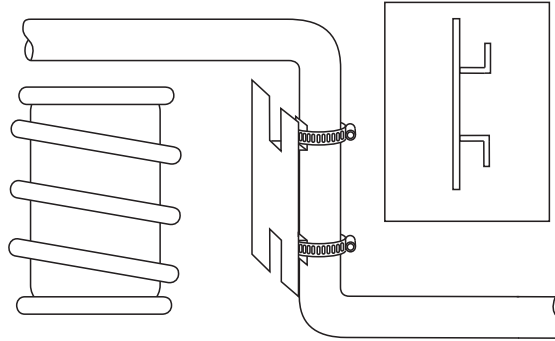

fig. 17



fig. 18

4. Bend the heat shield to form it around the tail pipe. Be sure to maintain a “dead air” space of 1/2” to 1” between the tail pipe and the heat shield (Fig. 19).

### NOTE

*Make sure installation does not interfere with moving parts, gas lines, etc.*

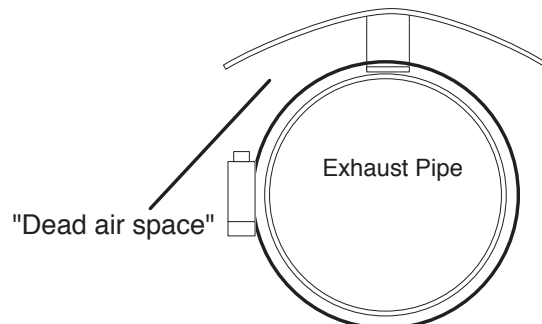
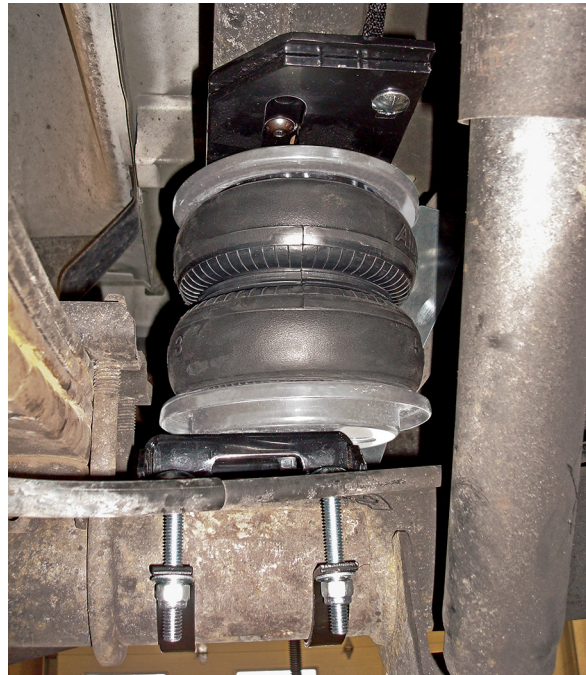

fig. 19

## VIEWS OF THE INSTALLED ASSEMBLY

1. Figure 20 shows a front view of the right (passenger) side assembly.



*fig. 20*

2. Figure 21 shows a rear view of the right (passenger) side.

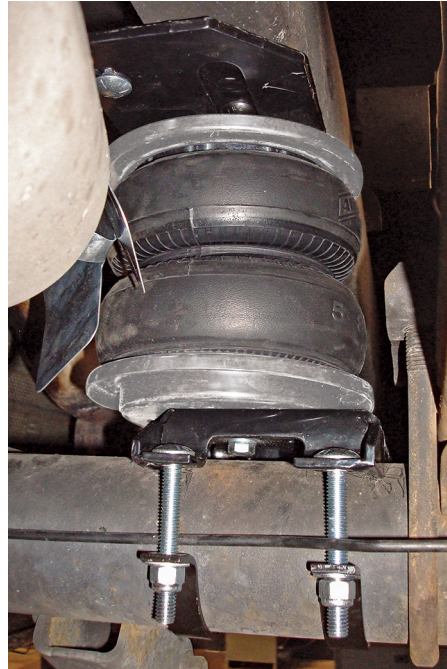

*fig. 21*

3. Figure 22 shows an inside rear view of the left (driver) side assembly.

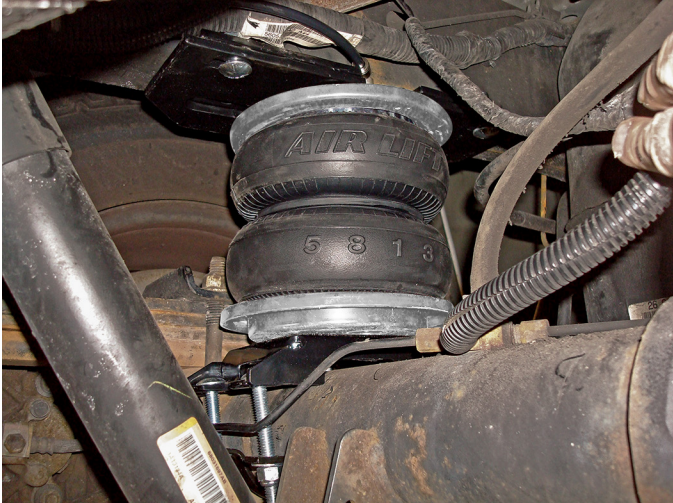

fig. 22

4. Figure 23 shows a rear view of the left (driver) side installation.



fig. 23

## INSTALLING THE AIR LINES

1. Choose a convenient location for mounting the inflation valves. Popular locations for the inflation valve are:
  - a. The wheel well flanges
  - b. The license plate recess in bumper
  - c. Under the gas cap access door
  - d. Through the license plate

### NOTE

*Whatever the chosen location, make sure there is enough clearance around the inflation valves for an air chuck.*

2. Drill two 5/16" holes to install the inflation valves.
3. Cut the air line assembly in two equal lengths.

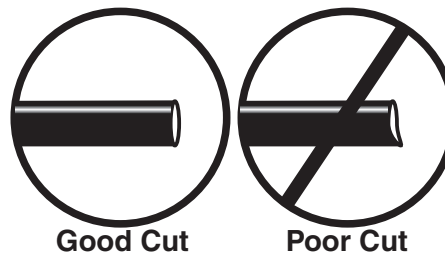

fig. 24

### CAUTION

WHEN CUTTING OR TRIMMING THE AIR LINE, USE A HOSE CUTTER, A RAZOR BLADE, OR A SHARP KNIFE. A CLEAN, SQUARE CUT WILL ENSURE AGAINST LEAKS. DO NOT USE WIRE CUTTERS OR SCISSORS TO CUT THE AIR LINE. THESE TOOLS MAY FLATTEN OR CRIMP THE AIR LINE CAUSING IT TO LEAK AROUND THE O-RING SEAL INSIDE THE ELBOW FITTING (FIG. 24).

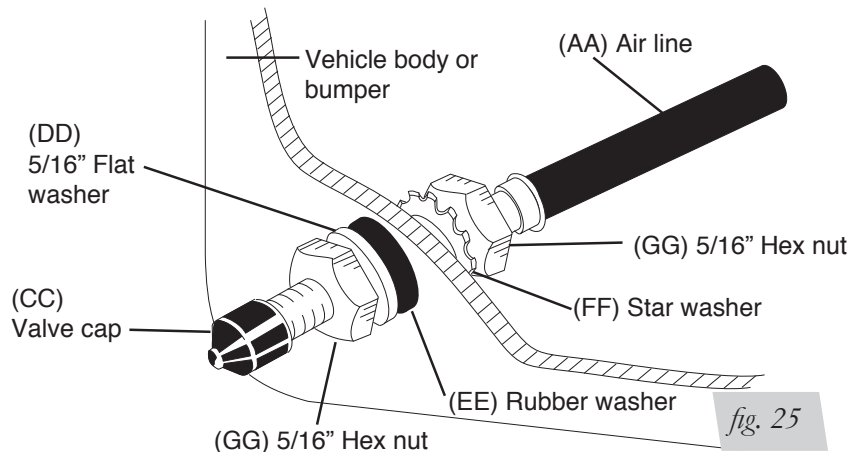
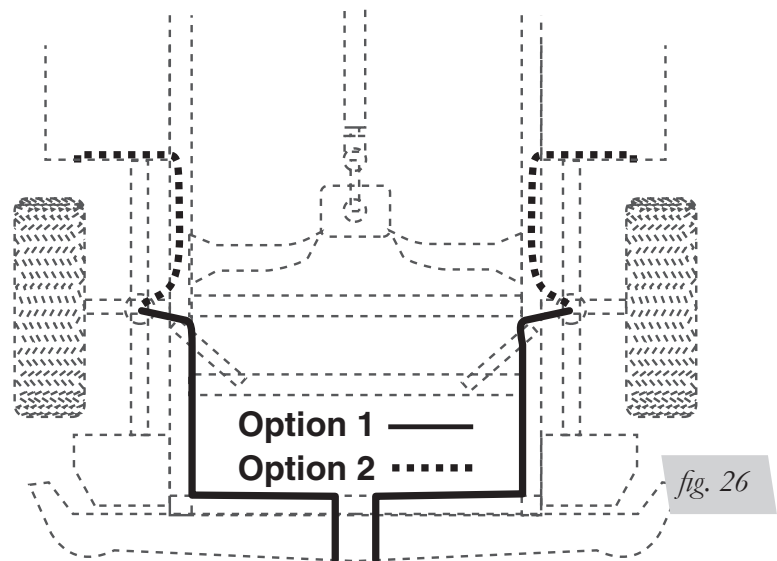

fig. 25

4. Place a 5/16" nut and star washer on the air valve. Leave enough of the inflation valve in front of the nut to extend through the hole and have room for the rubber washer, flat washer, and 5/16" nut and cap. There should be enough valve exposed after installation—approximately 1/2"—to easily apply a pressure gauge or an air chuck (fig. 25).
5. Push the inflation valve through the hole and use the rubber washer, flat washer, and another 5/16" nut to secure it in place. Tighten the nuts to secure the assembly.
6. Route the air line along the frame to the air fitting on the air spring (fig. 26). Keep AT LEAST 6" of clearance between the air line and heat sources, such as the exhaust pipes, muffler, or catalytic converter. Avoid sharp bends and edges. Use the plastic tie straps to secure the air line to fixed, non-moving points along the chassis. Be sure that the tie straps are tight, but do not pinch the air line. Leave at least 2" of slack to allow for any movement that might pull on the air line.





7. Cut off the air line, leaving approximately 12" of extra air line. A clean square cut will ensure against leaks. Insert the air line into the air fitting. This is a push-to-connect fitting. Simply push the air line into the 90° swivel fitting until it bottoms out (9/16" of air line should be in the fitting).

## CHECKING FOR LEAKS

1. Inflate the air spring to 30 PSI.
2. Spray all connections and the inflation valves with a solution of 1/5 liquid dish soap and 4/5 water. Spot leaks easily by looking for bubbles in the soapy water.
3. After the test, deflate the springs to the minimum pressure required to restore the system to normal ride height. Do not deflate to lower than 5 PSI.
4. Check the air pressure again after 24 hours. A 2 - 4 PSI loss after initial installation is normal. Retest for leaks if the loss is more than 5 lbs.

## FIXING LEAKS

1. If there is a problem with the swivel fitting:
  - a. Check the air line connection by deflating the spring and removing the line by pulling the collar against the fitting and pulling firmly on the air line. Trim 1" off the end of the air line. Be sure the cut is clean and square (see fig. 24). Reinsert the air line into the push-to-connect fitting.
  - b. Check the threaded connection by tightening the swivel fitting another ½ turn. If it still leaks, deflate the air spring, remove the fitting, and re-coat the threads with thread sealant. Reinstall by hand tightening as much as possible and then use a wrench for an additional two turns.
2. If there is a problem with the inflation valve:
  - a. Check the valve core by tightening it with a valve core tool.
  - b. Check the air line by removing the air line from the barbed type fitting. Cut the air line off a few inches in front of the fitting and use a pair of pliers or vice grips to pull/twist the air line off of the fitting.



### CAUTION

DO NOT CUT OFF THE AIR LINE COMPLETELY AS THIS WILL USUALLY NICK THE BARB AND RENDER THE FITTING USELESS.

3. If the preceding steps have not resolved the problem, call Air Lift customer service at (800) 248-0892.

# Before Operating

## INSTALLATION CHECKLIST (To be completed by installer)

- Clearance test — Inflate the air springs to 60 PSI and ensure there is at least ½” clearance around each bellow, away from anything that might rub against them. Be sure to check the tire, brake drum, frame, shock absorbers and brake cables.
- Leak test before road test — Inflate the air springs to 60 PSI, check all connections for leaks with a soapy water solution. See the *Checking for Leaks* section for tips on how to spot leaks. All leaks must be eliminated before the vehicle is road tested.
- Heat test — Be sure there is sufficient clearance from any heat sources — at least 6” for air springs and air lines. If a heat shield was included in the kit, install it. If there is no heat shield, but one is required, call (800) 248-0892.
- Fastener test — Recheck all bolts for proper torque. Re-torque after 100 miles.
- Road test — The vehicle should be road tested after the preceding tests. Inflate the air springs to 25 PSI (50 PSI if the vehicle is loaded). Drive the vehicle 10 miles and recheck for clearance, loose fasteners and air leaks.
- Operating instructions — If professionally installed, the installer should review the *Product Use, Maintenance and Servicing* section with the owner. Be sure to provide the owner with all of the paperwork which came with the kit.

**Technician's Signature** \_\_\_\_\_

**Date** \_\_\_\_\_

## POST-INSTALLATION CHECKLIST

- Overnight leak down test — Recheck air pressure after the vehicle has been used for 24 hours. If the pressure has dropped more than 5 PSI, then there is a leak that must be fixed. Either fix the leak yourself or return to the installer for service.
- Air pressure requirements — Regardless of load, the air pressure should always be adjusted to maintain ride height at all times.
- Thirty day or 500 mile test — Recheck the air spring system after 30 days or 500 miles, whichever comes first. If any part shows signs of rubbing or abrasion, the source should be identified and moved, if possible. If it is not possible to relocate the cause of the abrasion, the air spring may need to be remounted. If professionally installed, the installer should be consulted. Check all fasteners for tightness.

# Product Use, Maintenance and Servicing

Minimum Recommended Pressure	Maximum Air Pressure
5 PSI	100 PSI

## MAINTENANCE GUIDELINES

### NOTE

*By following the steps below, vehicle owners will obtain the longest life and best results from their air springs.*

1. Check the air pressure weekly.
2. Always maintain normal ride height. Never inflate beyond 100 PSI.
3. If you develop an air leak in the system, use a soapy water solution (1/5 liquid dish soap and 4/5 water) to check all air line connections and the inflation valve core before deflating and removing the air spring.

### CAUTION

FOR YOUR SAFETY AND TO PREVENT POSSIBLE DAMAGE TO YOUR VEHICLE, DO NOT EXCEED MAXIMUM GROSS VEHICLE WEIGHT RATING (GVWR), AS INDICATED BY THE VEHICLE MANUFACTURER. ALTHOUGH YOUR AIR SPRINGS ARE RATED AT A MAXIMUM INFLATION PRESSURE OF 100 P.S.I., THE AIR PRESSURE ACTUALLY NEEDED IS DEPENDANT ON YOUR LOAD AND GVWR.

4. Loaded vehicles require at least 25 PSI or more. A “loaded vehicle” refers to a vehicle with a heavy bed load, a trailer, or both. As discussed above, never exceed GVWR, regardless of air spring, air pressure, or other load assist. The springs in this kit will support approximately 40 lbs. of load (combined on both springs) for each 1 PSI of pressure. The required air pressure will vary depending on the state of the original suspension. Operating the vehicle below the minimum air spring pressure will void the Air Lift warranty.
5. When increasing load, always adjust the air pressure to maintain the normal ride height. Increase or decrease pressure from the system as necessary to attain normal ride height for optimal ride and handling. Remember that loads carried behind the axle (including tongue loads) require more leveling force (pressure) than those carried directly over the axle.
6. Always add air to springs in small quantities, checking the pressure frequently.
7. Should it become necessary to raise the vehicle by the frame, make sure the system is at minimum pressure (5 PSI) to reduce the tension on the suspension/brake components. Use of on board leveling systems do not require deflation or disconnection.
8. Periodically check the air spring system fasteners for tightness. Also, check the air springs for any signs of rubbing. Realign if necessary.
9. On occasion, give the air springs a hard spray with a garden hose in order to remove mud, sand, gravel or other abrasive debris.

## TROUBLESHOOTING GUIDE

1. Leak test the air line connections, the threaded connection into the air spring, and all fittings in the control system.
2. Inspect the air lines to be sure none are pinched. Tie straps may be too tight. Loosen or replace the strap and replace leaking components.
3. Inspect the air line for holes and cracks. Replace as needed.
4. Look for a kink or fold in the air line. Reroute as needed.

If the preceding steps do not solve the problem, it is possibly caused by a failed air spring — either a factory defect or an operating problem. Please call Air Lift at (800) 248-0892 for assistance.

## FREQUENTLY ASKED QUESTIONS

### Q. Will installing air springs increase the weight ratings of a vehicle?

No. Adding air springs will not change the weight ratings (GAWR, GCWR and/or GVWR) of a vehicle. Exceeding the GVWR is dangerous and voids the Air Lift warranty.

### Q. Is it necessary to keep air in the air springs at all times and how much pressure will they need?

For LoadLifter 5000 Ultimate, the recommended minimum air pressure is 5 PSI, but it can safely be run at zero air pressure.

### Q. Is it necessary to add a compressor system to the air springs?

No. Air pressure can be adjusted with any type of compressor as long as it can produce sufficient pressure to service the springs. Even a bicycle tire pump can be used, but it's a lot of work.

### Q. How long should air springs last?

If the air springs are properly installed and maintained they can last indefinitely.

### Q. Will raising the vehicle on a hoist for service work damage the air springs?

No. The vehicle can be lifted on a hoist for short-term service work such as tire rotation or oil changes. However, if the vehicle will be on the hoist for a prolonged period of time, support the axle with jack stands in order to take the tension off of the air springs.

## TUNING THE AIR PRESSURE

Pressure determination comes down to three things — level vehicle, ride comfort, and stability.

### 1. Level vehicle

If the vehicle's headlights are shining into the trees or the vehicle is leaning to one side, then it is not level (fig. 2.1). Raise the air pressure to correct either of these problems and level the vehicle.

### 2. Ride comfort

If the vehicle has a rough or harsh ride it may be due to either too much pressure or not enough (fig. 2.2). Try different pressures to determine the best ride comfort.

### 3. Stability

Stability translates into safety and should be the priority, meaning the driver may need to sacrifice a perfectly level and comfortable ride. Stability issues include roll control, bounce, dive during braking and sponginess (fig. 2.3). Tuning out these problems usually requires an increase in pressure.



Bad headlight aim *fig. 2.1*



Rough ride *fig. 2.2*



Sway and body roll *fig. 2.3*

## GUIDELINES FOR ADDING AIR

1. Start with the vehicle level or slightly above.
2. When in doubt, always add air.
3. If the front of the vehicle dives while braking, increase the pressure in the front air bags, if equipped.
4. If it is ever suspected that the air bags have bottomed out, increase the pressure (fig. 2.4).
5. Adjust the pressure up and down to find the best ride.
6. If the vehicle rocks and rolls, adjust the air pressure to reduce movement.
7. It may be necessary to maintain different pressures on each side of the vehicle. Loads such as water, fuel, and appliances will cause the vehicle to be heavier on one side (fig. 2.5). As much as a 50 PSI difference is not uncommon.



Bottoming out

*fig. 2.4*

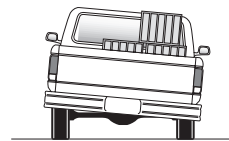

Unlevel

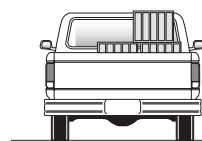

Level

*fig. 2.5*

# Choosing the Right On-Board Air Compressor System

**60 DAY** NO QUESTIONS ASKED, MONEY-BACK GUARANTEE

**TWO YEAR** COMPRESSOR SYSTEM WARRANTY

Add an on-board air compressor system to inflate and deflate your air springs with the touch of a button — from inside or outside of the vehicle.

- For convenient, on-the-go control of your air springs, add an Air Lift on-board air compressor system.
- Air Lift on-board air compressor systems eliminate the search for gas stations that have a working compressor, saving you time, energy and money.
- All systems include a compressor, controller and all parts needed for easy installation.

**1. Choose single or dual path inflation (see illustrations at right)**

**2. Choose wireless or analog control**

- **Wireless:** Control your air springs from inside or outside the vehicle. Easiest installation - no wires to the cab.
- **Analog:** In-cab control of your air springs. Economically priced.

**3. Choose heavy or standard duty compressor**

- **Standard duty:** A standard duty compressor will work well for most customers who use their system on an intermittent basis.
- **Heavy duty:** For daily use, consider the heavy duty compressor - it inflates faster and more quietly than the standard compressor.

Visit [www.airliftcompany.com](http://www.airliftcompany.com) for more detailed info on compressor systems.

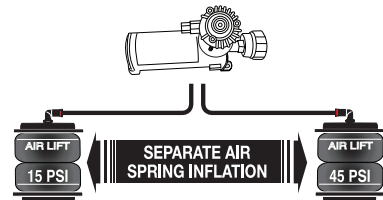

*Dual path systems* Air springs are controlled separately to allow for different air pressure from side-to-side. Perfect for uneven or top-heavy loads.

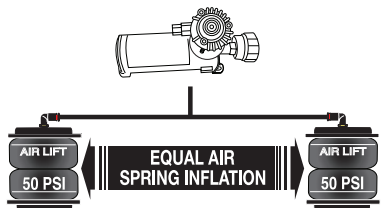

*Single path systems* Two springs will inflate at the same time. Good for loads that are evenly distributed from left-to-right or front-to-back.

W I R E L E S S

A N A L O G

DUAL PATH

**WirelessAIR™**

**OUR PREMIUM SYSTEM!**

- Easy installation
- Includes heavy duty compressor



P/N 72000

SINGLE PATH

**WirelessONE™**

- Easy installation
- Includes standard duty compressor



P/N 25870

**LoadCONTROLLER™**

**Dual**

Compact, economically priced control.



P/N Standard Duty Compressor 25850; P/N Heavy Duty Compressor 25854

**LoadCONTROLLER™**

**Single**

Compact, economically priced control.



P/N Standard Duty Compressor 25852; P/N Heavy Duty Compressor 25856



# Warranty and Returns Policy

Air Lift Company warrants its products, for the time periods listed below, to the original retail purchaser against manufacturing defects when used on catalog-listed applications on cars, vans, light trucks and motorhomes under normal operating conditions for as long as Air Lift manufactures the product. The warranty does not apply to products that have been improperly applied, improperly installed, used in racing or off-road applications, used for commercial purposes, or which have not been maintained in accordance with installation instructions furnished with all products. The consumer will be responsible for removing (labor charges) the defective product from the vehicle and returning it, transportation costs prepaid, to the dealer from which it was purchased or to Air Lift Company for verification.

Air Lift will repair or replace, at its option, defective products or components. A minimum \$10.00 shipping and handling charge will apply to all warranty claims. Before returning any defective product, you must call Air Lift at (800) 248-0892 in the U.S. and Canada (elsewhere, (517) 322-2144) for a Returned Materials Authorization (RMA) number. Returns to Air Lift can be sent to: Air Lift Company • 2727 Snow Road • Lansing, MI • 48917.

Product failures resulting from abnormal use or misuse are excluded from this warranty. The loss of use of the product, loss of time, inconvenience, commercial loss or consequential damages is not covered. The consumer is responsible for installation/reinstallation (labor charges) of the product. Air Lift Company reserves the right to change the design of any product without assuming any obligation to modify any product previously manufactured.

This warranty gives you specific legal rights and you may also have other rights that vary from state-to-state. Some states do not allow limitations on how long an implied warranty lasts or allow the exclusion or limitation of incidental or consequential damages. The above limitation or exclusion may not apply to you. There are no warranties, expressed or implied including any implied warranties of merchantability and fitness, which extend beyond this warranty period. There are no warranties that extend beyond the description on the face hereof. Seller disclaims the implied warranty of merchantability. (Dated proof of purchase required.)

<b>Air Lift 1000</b> .....	<b>Lifetime Limited</b>	<b>LoadController/Dual</b> .....	<b>2 Year Limited</b>
<b>RideControl</b> .....	<b>Lifetime Limited</b>	<b>Load Controller (I)</b> .....	<b>2 Year Limited</b>
<b>LoadLifter 5000*</b> .....	<b>Lifetime Limited</b>	<b>Load Controller (II)</b> .....	<b>2 Year Limited</b>
<b>LoadLifter 5000 Ultimate</b> ...	<b>Lifetime Limited</b>	<b>SmartAir</b> .....	<b>2 Year Limited</b>
<b>SlamAir</b> .....	<b>Lifetime Limited</b>	<b>Wireless AIR</b> .....	<b>2 Year Limited</b>
<b>AirCell</b> .....	<b>Lifetime Limited</b>	<b>WirelessONE</b> .....	<b>2 Year Limited</b>
<b>Air Lift Performance**</b> .....	<b>1 Year Limited</b>	<b>Other Accessories</b> .....	<b>2 Year Limited</b>
<b>LoadController/Single</b> .....	<b>2 Year Limited</b>		

*\*formerly SuperDuty  
\*\*formerly LifeSTYLE & Performance, EasyStreet*

## Replacement Information

If you need replacement parts, contact the local dealer or call Air Lift customer service at (800) 248-0892. Most parts are immediately available and can be shipped the same day.

**Contact Air Lift Company customer service at (800) 248-0892, first if:**

- Parts are missing from the kit.
- Need technical assistance on installation or operation.
- Broken or defective parts in the kit.
- Wrong parts in the kit.
- Have a warranty claim or question.

**Contact the retailer where the kit was purchased:**

- If it is necessary to return or exchange the kit for any reason.
- If there is a problem with shipping if shipped from the retailer.
- If there is a problem with the price.

## Contact Information

If you have any questions, comments or need technical assistance, contact our customer service department by calling (800) 248-0892, Monday through Friday. For calls from outside the USA or Canada, our local number is (517) 322-2144.

For inquiries by mail, our address is PO Box 80167, Lansing, MI 48908-0167. Our shipping address for returns is 2727 Snow Road, Lansing, MI 48917.

You may also contact us anytime by e-mail at [sales@airliftcompany.com](mailto:sales@airliftcompany.com) or on the web at [www.airliftcompany.com](http://www.airliftcompany.com).





# Notes

# Notes



# Notes

## Need Help?

Contact our customer service department by calling (800) 248-0892, Monday through Friday. For calls from outside the USA or Canada, our local number is (517) 322-2144.

**Register your warranty online at  
[www.airliftcompany.com/warranty](http://www.airliftcompany.com/warranty)**



*Thank you for purchasing Air Lift products — the professional installer's choice!*

Air Lift Company • 2727 Snow Road • Lansing, MI 48917 or PO Box 80167 • Lansing, MI 48908-0167  
Toll Free (800) 248-0892 • Local (517) 322-2144 • Fax (517) 322-0240 • [www.airliftcompany.com](http://www.airliftcompany.com)

Printed in  
the USA