



Buy products from authorized and licensed manufacturers using any of our patented processes, beware of cheap knock-offs, look for our licensing logo.

MR Technology Step down process:

- 1- Calibration Method for Air Intake Tracts for Internal Combustion Engines. Patent# 7,359,795
- 2- Calibration Device for Air Intake Tracts for Internal Combustion Engines. Published and patent pending
- 3- Calibration Method and Device for Air Intake Tracts having Air Fusion Published and patent pending
- 4- Tuning Method and Device for intake tracts having built-in Air Filter Horns patent pending

Injen is the first and only intake manufacturer that tunes and controls air/fuel ratios, short/long term fuel trim levels using the MR step down process, Air Fusion and built-in air intake horns.

**Part number PF7013
2012-14 Chevy Camaro
3.6L V6**

1- 3.5" diameter intake system
equipped with MR Tech

- 1- 5" Super-Flowdry filter (#1051)
- 1- step hose (#3133)
- 1- step elbow hose (#3145)
- 1- 3.75" velocity stack (#6049)
- 1- Power clamps 064 (#4006)
- 1- Power clamps 048 (#4004)
- 2- Power clamps 056 (#4005)
- 1- 6"- 15mm vacuum hose (#3079)
- 2- m4 x 10mm hex bolt (#6047)
- 1- molded stand-off (#15023)
- 1- fender washer (#6010)
- 1- m6 nut (#6002)
- 1- heat shield (#11061)
- 1- cover shield (#11062)
- 2- grommet (#8031)
- 8- m6 allen button head (#6083)
- 1- trim seal @ 10.5"L (#6058)
- 1- trim seal @ 14"L (#6058)
- 1- trim seal @ 17.5"L (#6058)

Congratulations! You have just purchased the best engineered, dyno-proven cold air intake system available.

Please check the contents of this box immediately.

Report any defective or missing parts to the Authorized Injen Technology dealer you purchased this product from. Before installing any parts of this system, please read the instructions thoroughly. If you have any questions regarding installation please contact the dealer you purchased this product from. Installation DOES require some mechanical skills. A qualified mechanic is always recommended. *Do not attempt to install the intake system while the engine is hot. The installation may require removal of radiator fluid line that may be hot. Injen Technology offers a limited lifetime warranty to the original purchaser against defects in materials and workmanship. Warranty claims must be handled through the dealer from which the item was purchased.

Injen Technology 244 Pioneer Place Pomona, CA 91768 USA

Please check the contents of this box immediately.

Injen strongly recommends that this system be installed by a professional mechanic.

MR Technology, "The World's First Tuned air Intake System!"

Factory safe air/fuel ratio's for Optimum performance Patent# 7,359,795

Now equipped with "Air Fusion" Patented

This intake system is equipped with the first ever Air Intake Horns Patent pending

"At Injen Technology, we didn't copy the step down process, we invented it!"





Figure 3

Stock air intake cleaner and air ducts shown in this picture. Before getting started with the installation, disconnect the negative battery terminal.



Figure 4

Pull the engine cover out from the stand-offs and remove the engine cover from the engine compartment.



Figure 5

Pull the vacuum hard pipe out of the CCV box grommet as shown above.

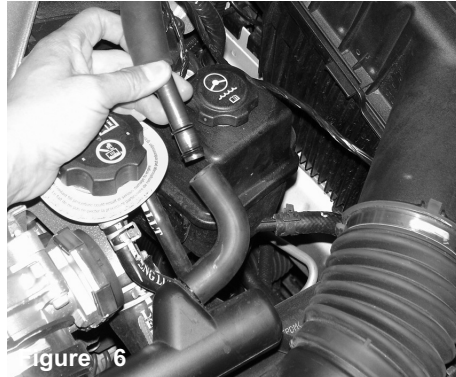

Figure 6

Depress the tab and pull the electrical harness connector from the mass air flow sensor.

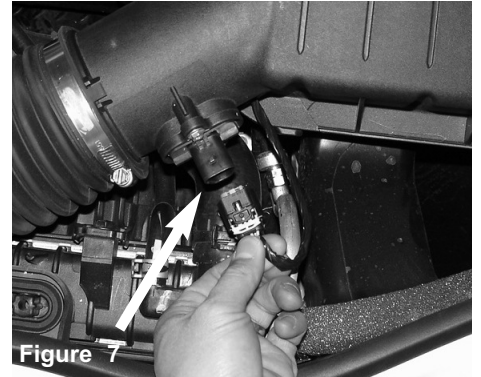

Figure 7

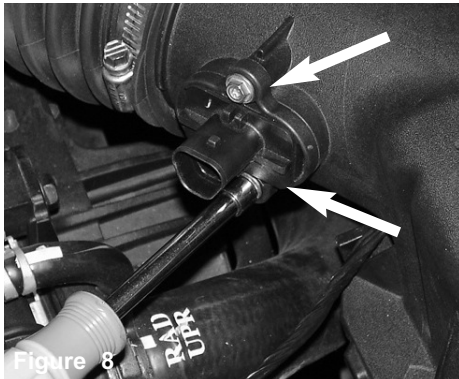

Figure 8

Loosen and remove the two screws holding the mass air flow sensor in the sensor housing.

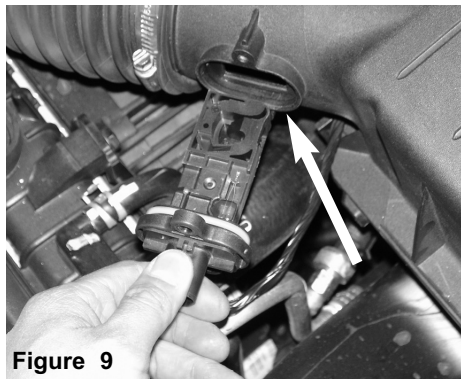

Figure 9

Once you have removed the screws, continue to pull the mass air flow sensor out of the sensor housing.

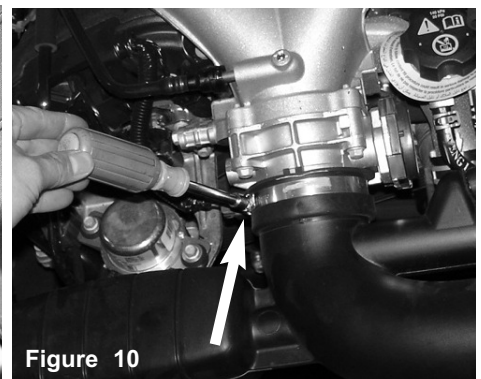

Figure 10

Loosen the throttle body clamp over the air intake duct.



Figure 11

Once you have loosened the clamp, continue to pull the air intake duct from the throttle body.

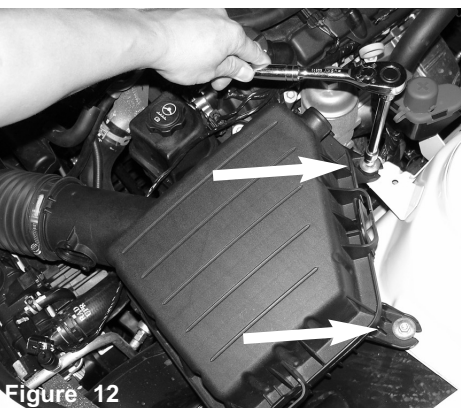

Figure 12

Remove the two M6 nuts holding the air box cleaner to the strut tower mount.



Figure 13

Remove the complete stock air box out of vehicle.

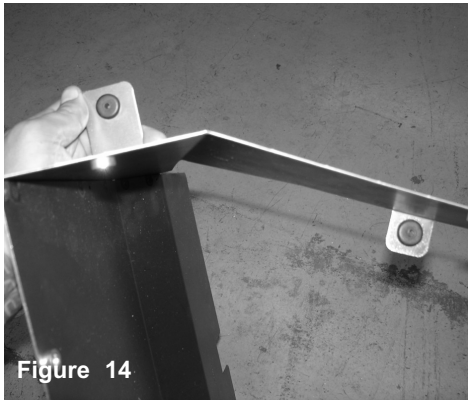

Figure 14

Install the 2 provided grommets to the hole cut outs on heat shield.

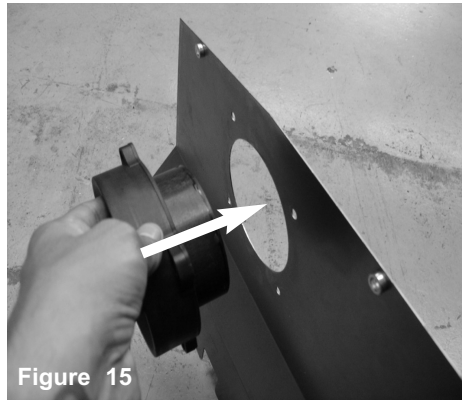

Figure 15

Install the velocity adapter to inside of heat shield.

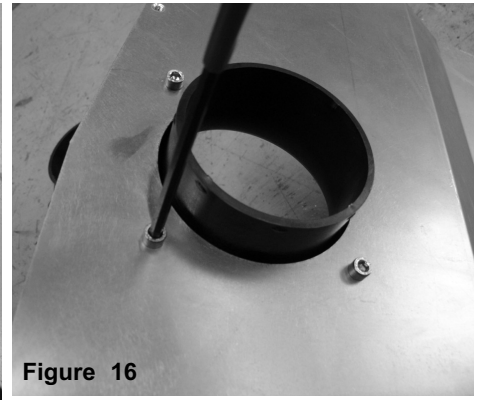

Figure 16

With provided M6 allen screws, secure and tighten the adapter to heat shield

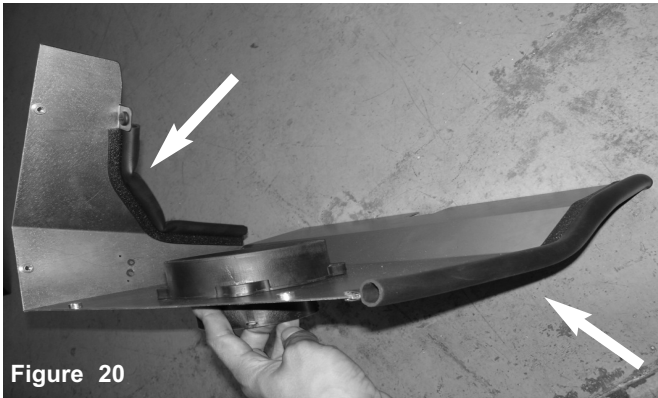

Figure 20

Attach trim seal to side of heat shields,

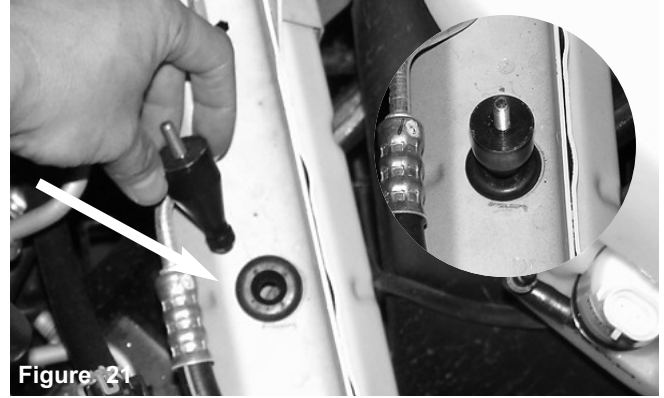

Figure 21

With m6 stand off stud, install to grommet on frame. Make sure that the stand off stud is seated properly.

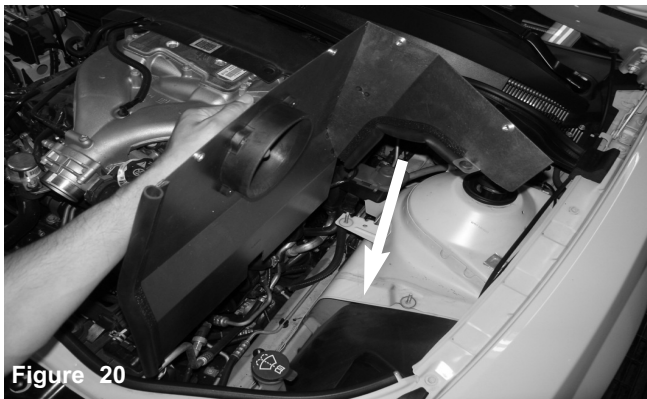

Figure 20

Install complete heat shield into vehicle and position to factory.



Figure 21

Guide the 2 tabs to factory studs on engine compartment,

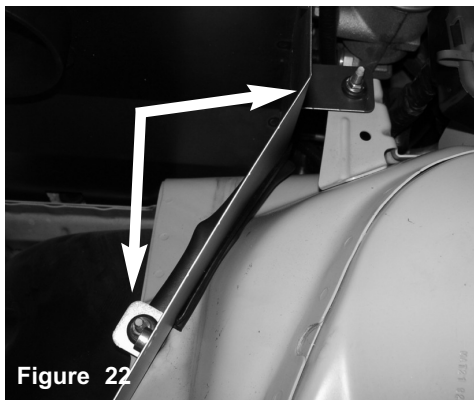

Figure 22

Use factory M6 nuts to secure the heat shield



Figure 23

Secure the bottom of the housing tab using washer and nut. Tighten all nuts using 10mm socket and ratchet.

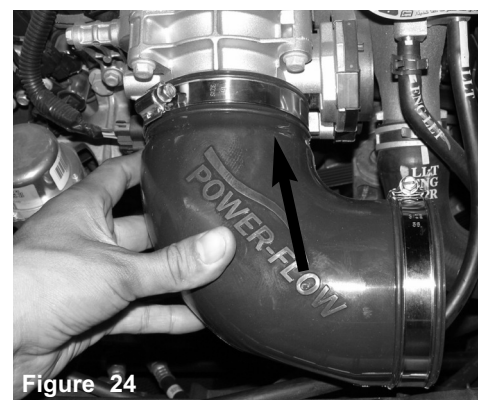

Figure 24

Install elbow with clamps provided to throttle body and secure using 8mm nut driver.



Figure 25

Install MAF sensor to intake tube.

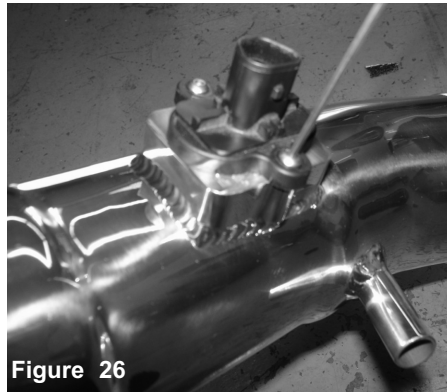

Figure 26

Secure the MAF sensor using the 2 M4 screws provided and tighten using 2.5mm allen key.

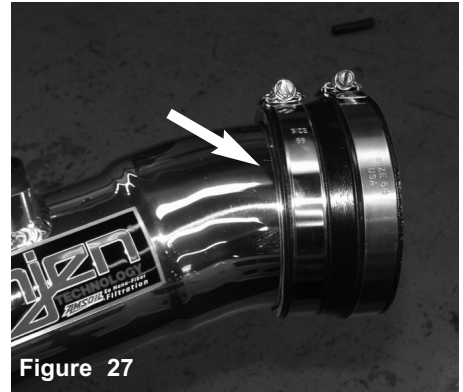

Figure 27

Install the step hose with clamps to intake tube.



Figure 28

Install intake tube to vehicle and position to elbow and adapter.

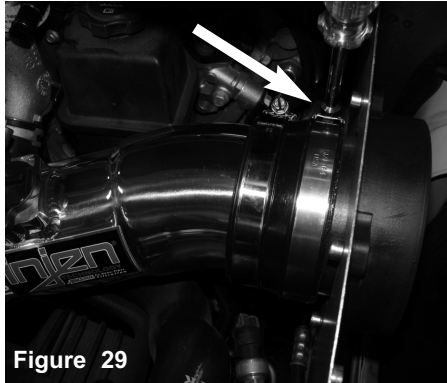

Figure 29

Position for best possible fit and tighten clamps on step hose using 8mm nut driver.

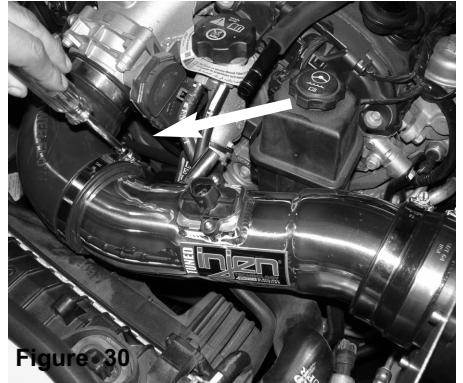

Figure 30

Tighten all clamps on elbow.

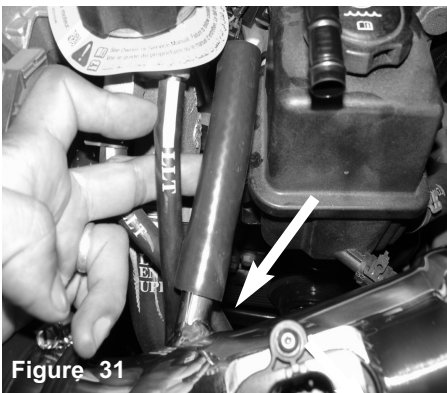

Figure 31

Install the hose to fitting on intake tube.



Figure 32

Connect the engine crank case line to hose.

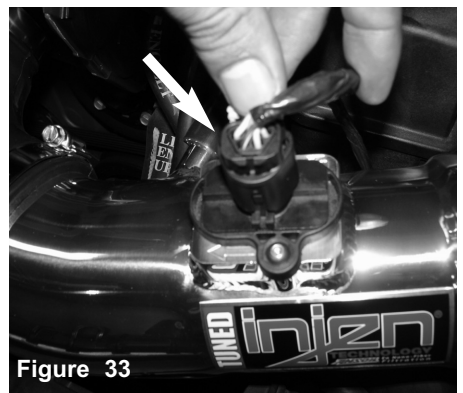

Figure 33

Re-connect MAF sensor harness.

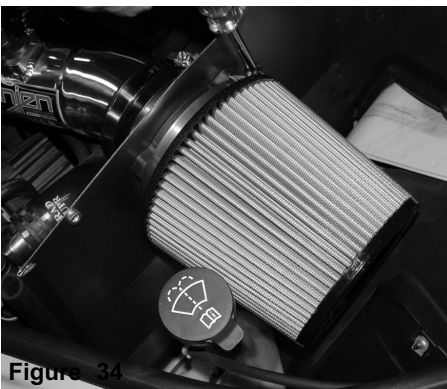

Figure 34

Install air filter to adapter and tighten using 8mm nut driver.



Figure 35

Install cover to heat shield.

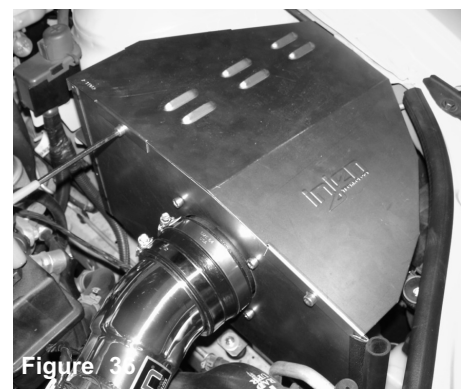

Figure 36

Secure the cover using the m6 allen screws and tighten using 6mm allen key.



The motor pump ascending line is removed from the barbed fitting.



The motor pump harness is disconnected from the motor pump

1. Upon completion of the installation, reconnect the negative battery terminal before you start the engine.
2. Align the entire intake system for the best possible fit. Once the intake has been properly fitted continue to tighten all nuts, bolts and clamps.
3. Periodically, recheck the alignment of the intake system and make sure there is proper clearance around and along the length of the intake. Failure to follow proper maintenance procedures may cause damage to the intake and will void the warranty.
4. Start the engine and listen carefully for any odd noises, rattles and/or air leaks prior to taking it for a test drive. If any problems arise go back and check the vacuum lines, hoses and clamps that maybe causing leaks or rattles and correct the problem.
5. Check the filter for excessive dirt build up. Clean or replace the filter with an original Injen filter (can be bought on-line at "injenonline.com"). Congratulations! You have just completed the installation of the best intake system sold on the market. Enjoy the added power and performance of your new intake system.