



INSTALLATION GUIDE: AWE EXHAUST SUITE FOR THE 4TH GEN 5.3L CHEVY SILVERADO 1500 AND GMC SIERRA 1500

For up-to-date fitment information, please visit the product page on [AWE-Tuning.com](https://www.AWE-Tuning.com).

THIS GUIDE IS INTENDED FOR THE FOLLOWING PART NUMBERS:

- 3015-42201 AWE 0FG Catback Split Rear Exit Exhaust for 4th Gen Silverado/Sierra 1500 5.3L (With Bumper Cut-outs) - Quad Chrome Silver Tips
- 3015-43202 AWE 0FG Catback Split Rear Exit Exhaust for 4th Gen Silverado/Sierra 1500 5.3L (With Bumper Cut-outs) - Quad Diamond Black Tips
- 3015-32205 AWE 0FG Catback Split Rear Exit Exhaust for 4th Gen Silverado/Sierra 1500 5.3L (Flat Bumper) - Chrome Silver Tips
- 3015-33206 AWE 0FG Catback Split Rear Exit Exhaust for 4th Gen Silverado/Sierra 1500 5.3L (Flat Bumper) - Diamond Black Tips
- 3015-22207 AWE 0FG Catback Single Side Exhaust for 4th Gen Silverado/Sierra 1500 5.3L (Flat Bumper) - Dual Chrome Silver Tips
- 3015-23208 AWE 0FG Catback Single Side Exhaust for 4th Gen Silverado/Sierra 1500 5.3L (Flat Bumper) - Dual Diamond Black Tips

Welcome to the AWE family, and congratulations on your purchase of the AWE Exhaust System for the 4th Gen Chevy Silverado 1500 5.3L and GMC Sierra 1500 5.3L.

Exquisite build quality and craftsmanship, coupled with industry leading performance, distinguish this exhaust system from all others.

*For up to the minute fitment information, be sure to visit the AWE website. As always, AWE Performance Specialists

PARTS LIST (SINGLE EXIT SYSTEMS)



Inspect **ALL** parts prior to disassembly of vehicle; If damaged or **MISSING**, please contact the place of purchase immediately.

Symbol	Part Number	Description	QTY
	E24	Silverado 4th Gen 5.3L Front Section w/ Flex	1
	E25	Silverado 4th Gen 5.3L HR5 Section	1
	E26	Silverado 4th Gen 5.3L Overaxle Inlet	1
	E30	Silverado 4th Gen 5.3L Single Exit Tube	1
	E41	Silverado 4th Gen 5.3L Long Wheel Base Adapter	1
	C17	Universal 3" Inlet Dual 3" Outlet Rear Merge Assembly	1
A >>	180300	AWE Band Clamp: 3"	7
B >>	3910-11012	Clamp Kit	1
C >>	61000455	4.50" OD x 3.00" ID, Slash Cut, Chrome Silver	2
	61000488	4.50" OD x 3.00" ID, Slash Cut, Diamond Black	2

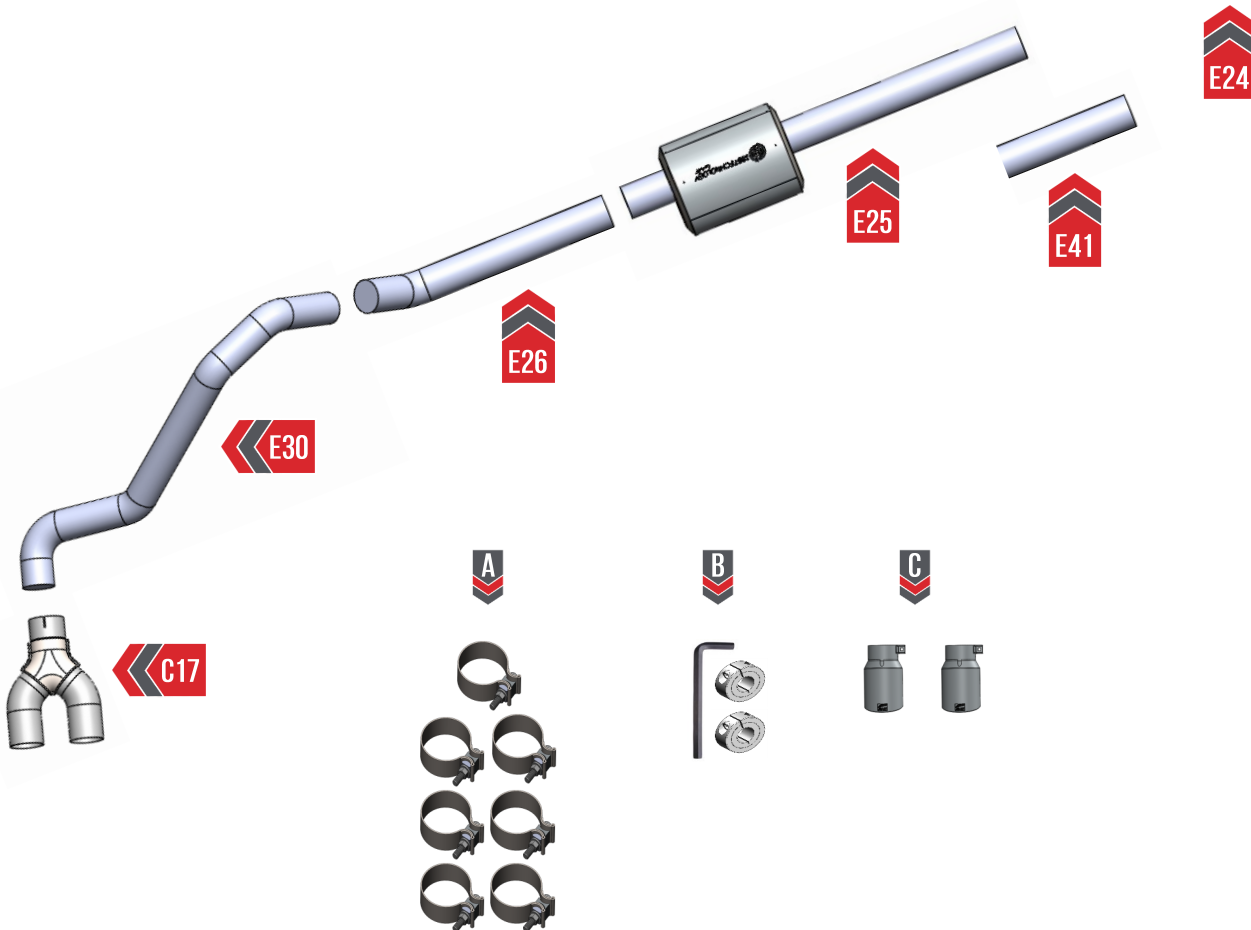

PARTS LIST (DUAL EXIT SYSTEMS)



Inspect **ALL** parts prior to disassembly of vehicle; If damaged or **MISSING**, please contact the place of purchase immediately.

Symbol	Part Number	Description	QTY
	E24	Silverado 4th Gen 5.3L Front Section w/ Flex	1
	E25	Silverado 4th Gen 5.3L HR5 Section	1
	E26	Silverado 4th Gen 5.3L Overaxle Inlet	1
	E27	Silverado 4th Gen 5.3L Overaxle Tri Section	1
	E31	Silverado 4th Gen 5.3L Driver Tailpipe w/o cutouts (Single 5")	1
	E32	Silverado 4th Gen 5.3L Passenger Tailpipe w/o cutouts (Single 5")	1
	E07	Silverado 4th Gen 5.3L DS/PS Rear Hanger	2
	E41	Silverado 4th Gen 5.3L Long Wheel Base Adapter	1
A >>	180300	AWE Band Clamp: 3"	8
B >>	3910-11012	Clamp Kit	2
C >>	610400	Rubber Exhaust Isolater	2
D >>		Hanger Bracket Hardware Kit	1
	180003BC	5" x 10", Straight Cut, Diamond Black Tip	2
E >>	180003	5"x10" Straight Cut Chrome Silver Tip	2

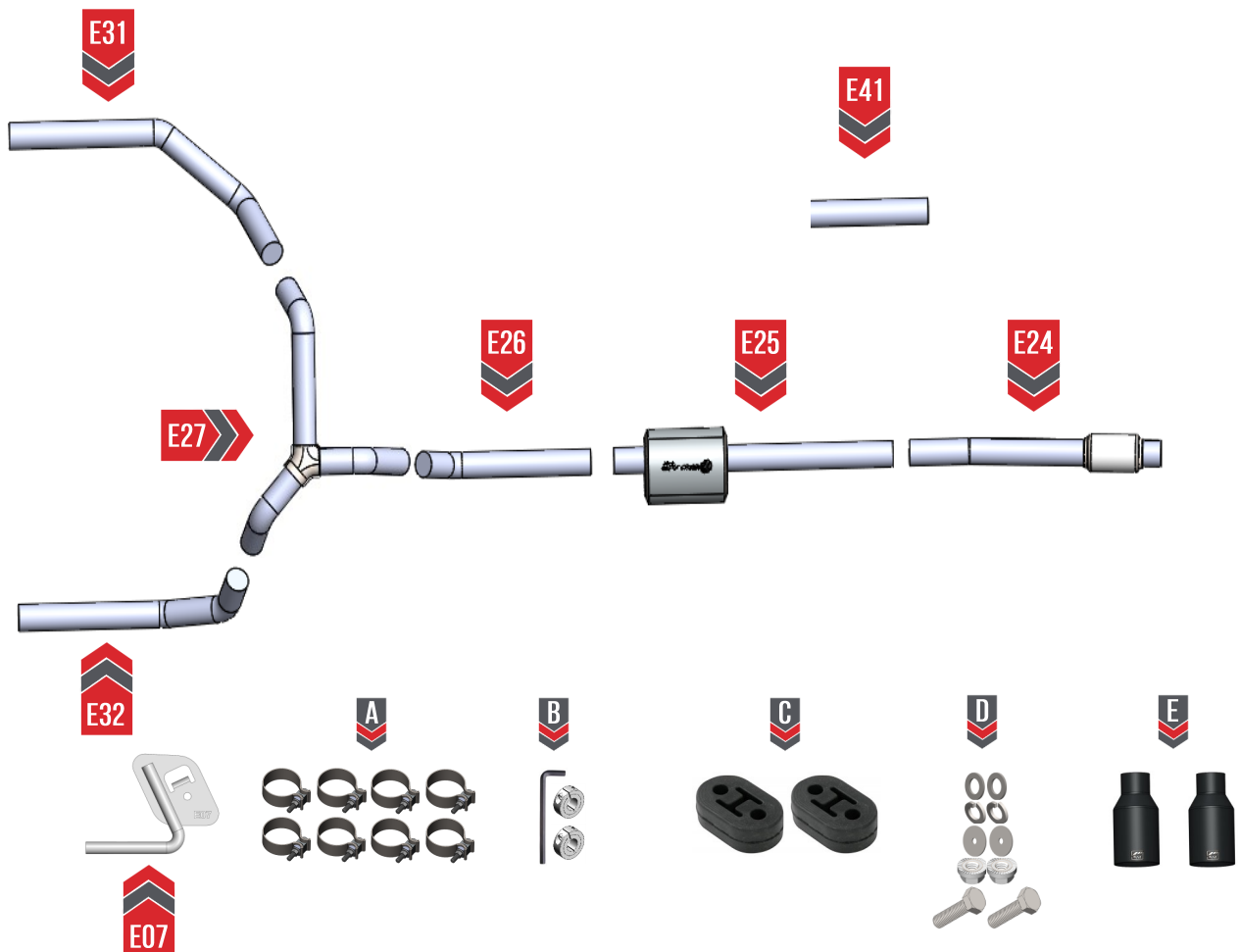

PARTS LIST (QUAD EXIT SYSTEMS)



Inspect **ALL** parts prior to disassembly of vehicle; If damaged or **MISSING**, please contact the place of purchase immediately.

Symbol	Part Number	Description	QTY
	E24	Silverado 4th Gen 5.3L Front Section w/ Flex	1
	E25	Silverado 4th Gen 5.3L HR5 Section	1
	E26	Silverado 4th Gen 5.3L Overaxle Inlet	1
	E27	Silverado 4th Gen 5.3L Overaxle Tri Section	1
	E28	Silverado 4th Gen 5.3L Driver Tailpipe w/cutouts (Quad 102)	1
	E29	Silverado 4th Gen 5.3L Passenger Tailpipe w/cutouts (Quad 102)	1
	E33	Silverado 4th Gen 5.3L/6.2L Tip Outlet (Quad 102 Outlet)	2
	E41	Silverado 4th Gen 5.3L Long Wheel Base Adapter	1
A >>	SEC75	3" Barrel Clamp (Bubble)	2
B >>	180300	AWE Band Clamp: 3"	6
C >>	3910-11012	Clamp Kit	1
	180010	4.00" OD x 2.50" ID, Slash Cut, Chrome Silver, AWE Logo	4
D >>	180011	4.00" OD x 2.50" ID, Slash Cut, Diamond Black, AWE Tuning	4

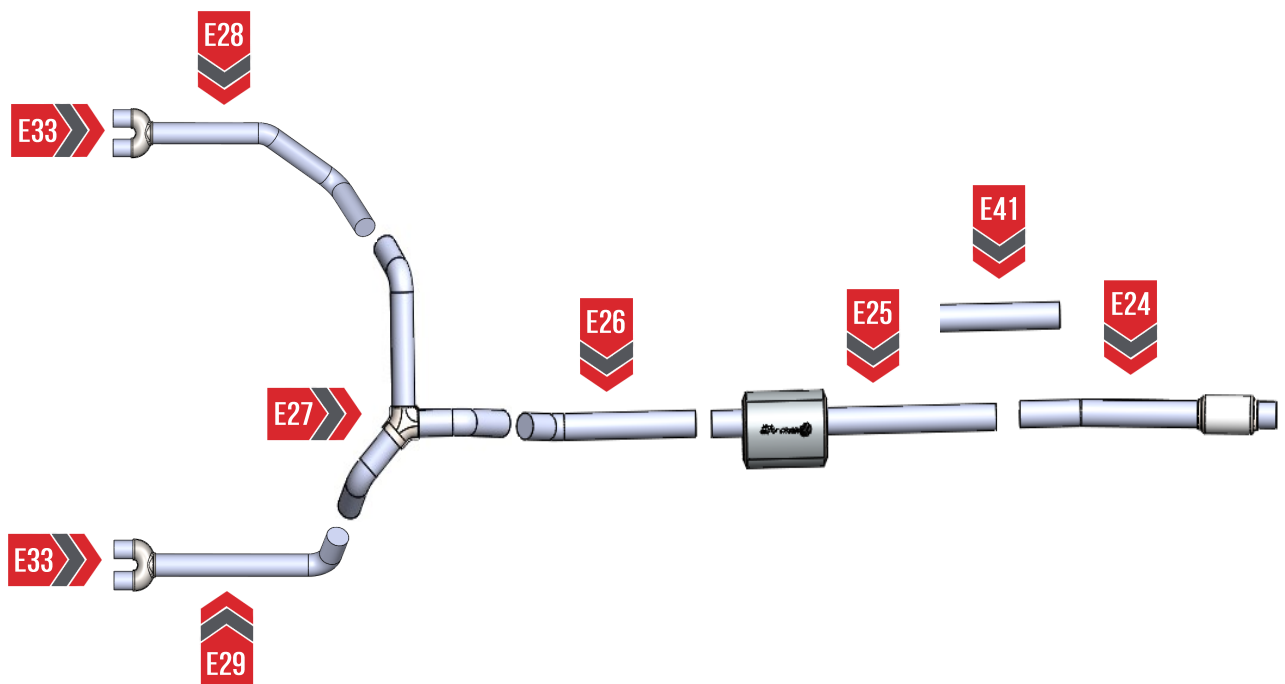



NOTE: Always refer to the manufacturer's service manual for precise torque specifications on all OEM fasteners.



CAUTION: The exhaust may be **VERY HOT** — allow adequate time for the system to cool down before disassembly. Severe burns and injury will occur if skin comes into contact with a hot exhaust system.

STEP 1

Begin removing your OE exhaust system by first removing your spare tire.

Next remove the OE heat shield, and hardware shown in **Figure 1** at (A).

Note: This will be reinstalled after you remove the OE exhaust

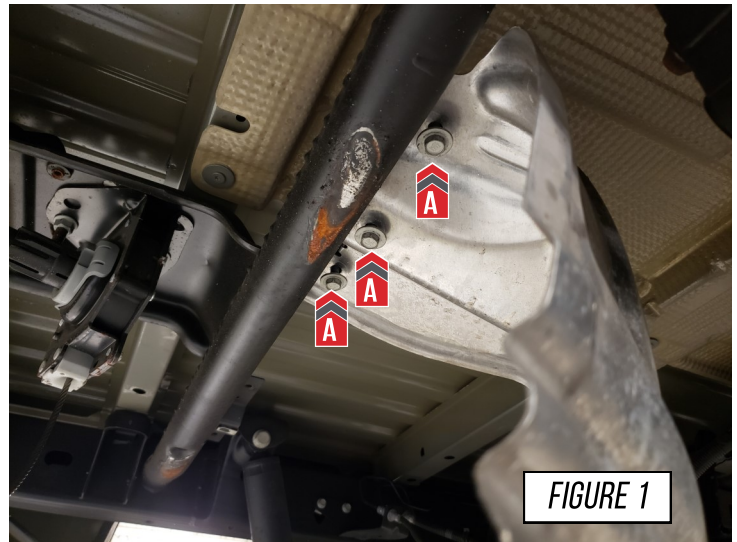



STEP 2A

Start by removing the OE single exit exhaust by following the steps, shown in **Figure 2A**.



Soak all bolts and rubber hangers in penetrating oil before starting any work.

1. To begin you will loosen the OE ball socket clamp, shown at **(A)**, enough to separate the two components.
2. Remove the 3 OE hangers from the exhaust shown at **(B)**.
3. With the OE exhaust no longer attached to the vehicle, remove the complete exhaust.

Note: The factory clamp will be used with your AWE exhaust.



Note: After the OE exhaust is completely removed, re-install the OE heat shield, and the spare tire.

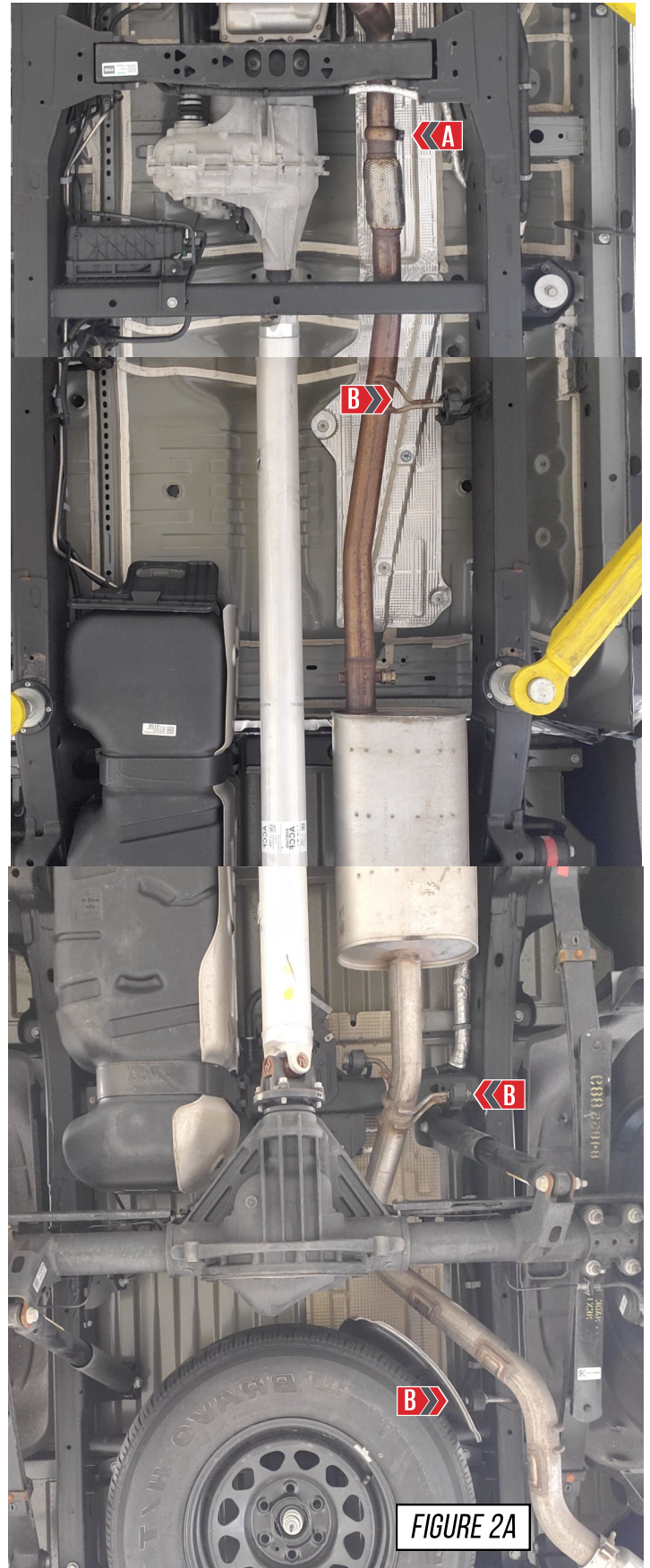

FIGURE 2A



STEP 2B

Start by removing the OE dual exit exhaust by following the steps, shown in **Figure 2B**.



Soak all bolts and rubber hangers in penetrating oil before starting any work.

1. To begin you will loosen the OE ball socket clamp, shown at **(A)**, enough to separate the two components.
2. Remove the 5 OE hangers from the exhaust shown at **(B)**.
3. With the OE exhaust no longer attached to the vehicle, remove the complete exhaust.
4. Remove the OE tip bezels by removing the 3 bolts per side marked at **(C)**. On each bezel, all 3 bolts are located on the top side.

Note: The factory clamp will be used with your AWE exhaust.

Note: The OE tip bezels will not be reused.



Note: After the OE exhaust is completely removed, re-install the OE heat shield, and the spare tire.

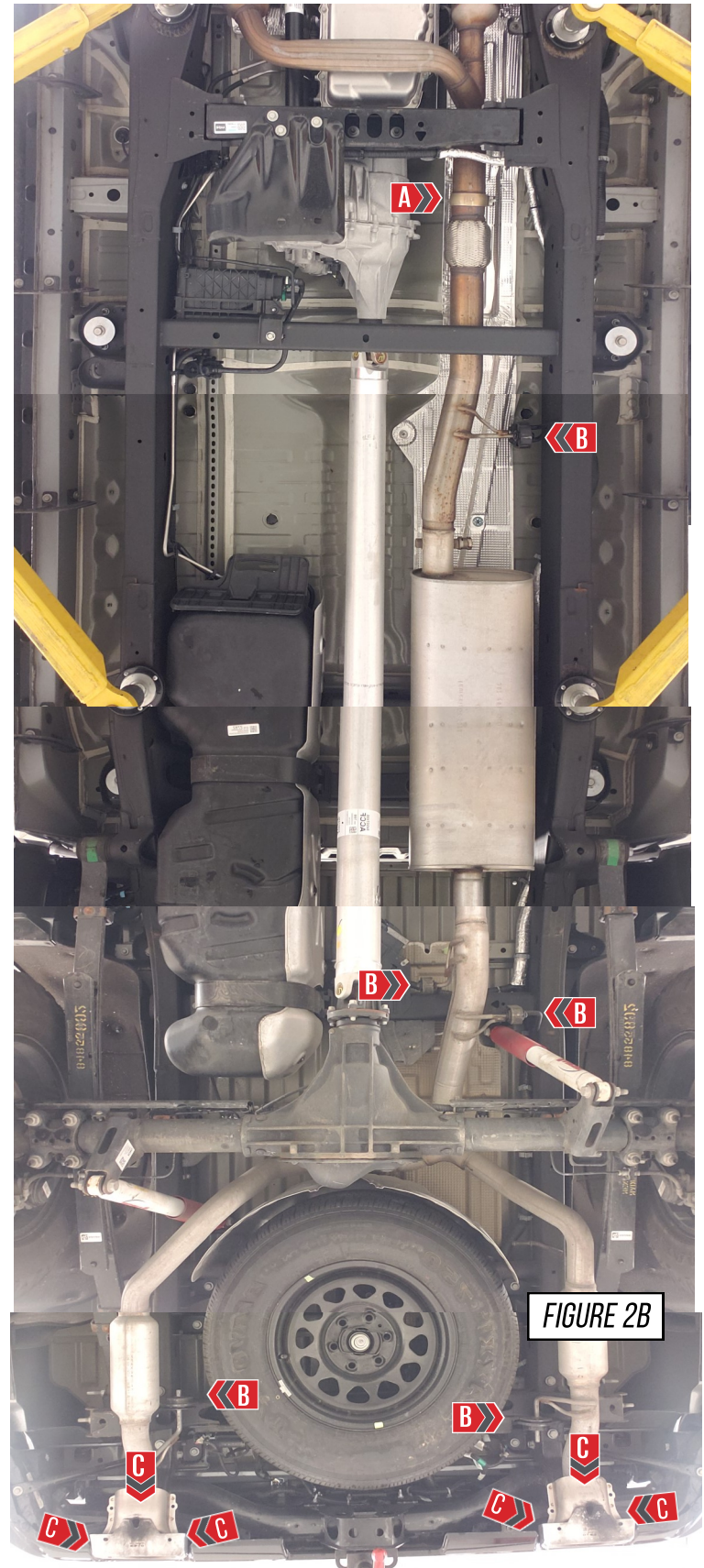
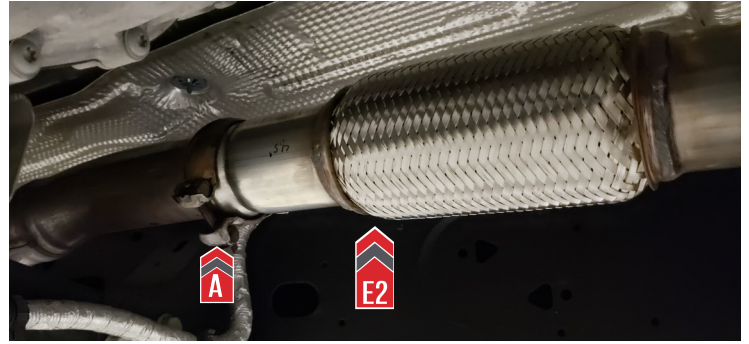

FIGURE 2B

STEP 3

Insert the ball flange on your AWE front section over the factory flared pipe, as shown at (A) in **Figure 3-1**. Slide the OE clamp onto your AWE inlet section (E24).

Slide the hanger bar into the OE hanger as shown at (B) in **Figure 3-2**. Snug the clamp but do not fully tighten it.



STEP 4



STEP 4 IS FOR LONG WHEEL BASE VEHICLES ONLY



If you have a long wheel base truck install your AWE long wheel base adapter (E41) after the AWE inlet section (E24). Slide a provided clamp on the adapter (E41), as shown at (A) in **Figure 4**. Snug the clamp but do not fully tighten it

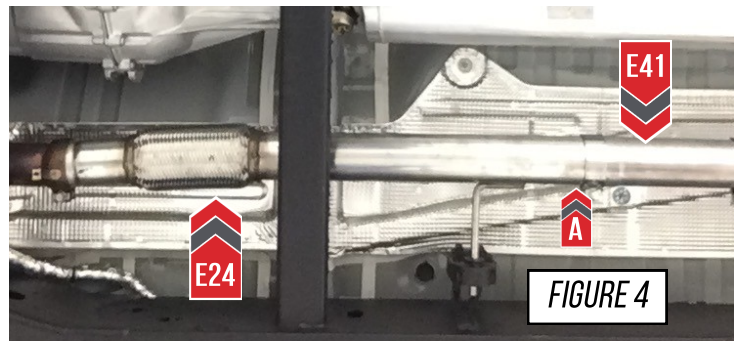

STEP 5

Slide one of the provided exhaust clamps onto the end of the pipe (A). Then install your AWE HR5 section (E25), as shown in Figure 5.

Note: Snug the clamp but do not fully tighten it at this point.



STEP 6

Place a provided exhaust clamp over the expanded end of your AWE overaxle inlet tube (E26), shown at (A) in Figure 6.

Bottom the slip fit on the HR5 section (E25).

When the tube is bottomed out slide the hanger bars into the hangers as shown at (B) in Figure 6.

Note: Snug the clamp down but do not tighten it fully at this time.

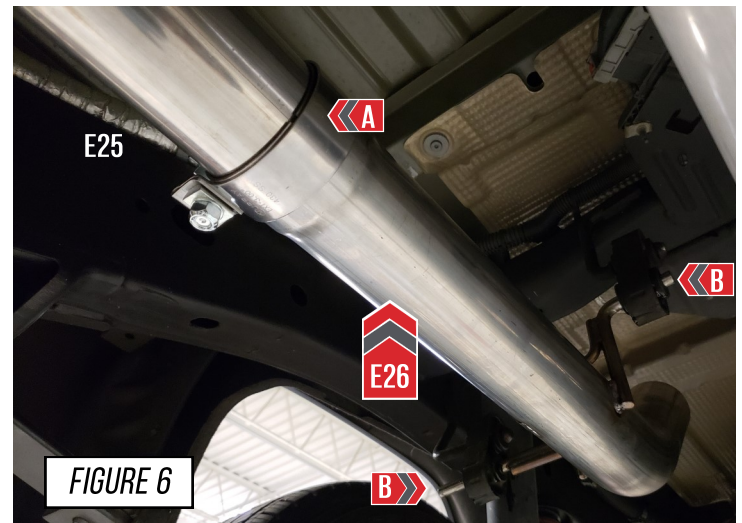

STEP 7

It is crucial to install each section and exhaust band clamps correctly to prevent loose joints, exhaust leaks and rattles.

Arrow A shows the expanded pipe and the preinstalled exhaust clamp being brought up to the corresponding pipe.

Arrow B shows the overlapping pipe installed correctly over the corresponding pipe.

Arrow C shows the exhaust band clamp being brought to the edge of the expanded pipe.



NOTES:

- **Do not** fully torque any exhaust clamp until the entire exhaust has been installed and adjusted.
- Torque specification is a **minimum** of 60 ft/lbs

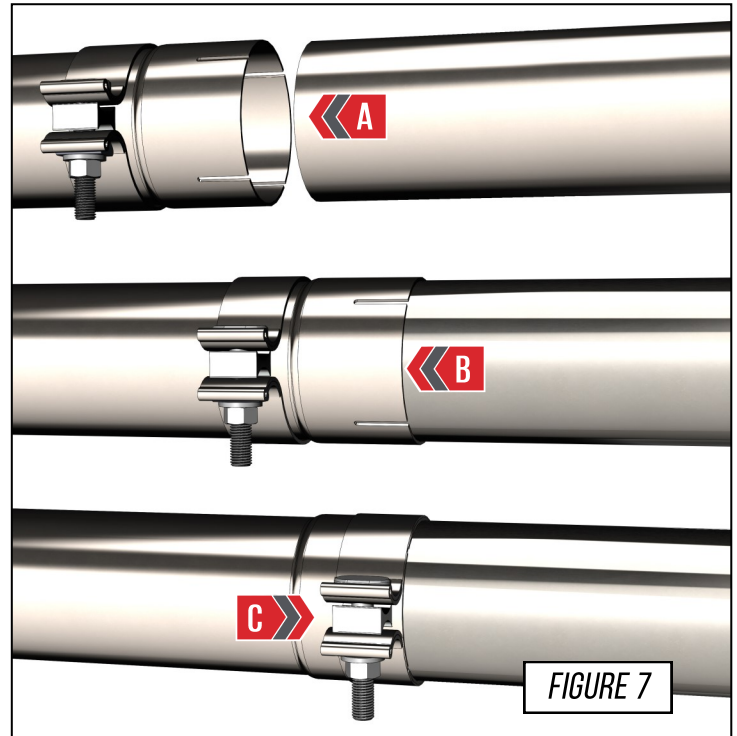

IF INSTALLING THE SINGLE EXIT EXHAUST SYSTEM, SKIP TO STEP 8



IF INSTALLING THE DUAL EXIT EXHAUST SYSTEM, SKIP TO STEP 14



IF INSTALLING THE QUAD TIP EXHAUST SYSTEM, SKIP TO STEP 21





STEPS 8-13 ARE FOR SINGLE EXIT SYSTEMS ONLY



STEP 8

Install your AWE single exit tube (**E30**), place a clamp on the up turned end of the AWE overaxle inlet tube (**E26**) shown at (**A**) in **Figure 8**.

Bottom out the slip joint, then slide the hanger bar into the factory hanger, as shown at (**A**) in **Figure 8**.

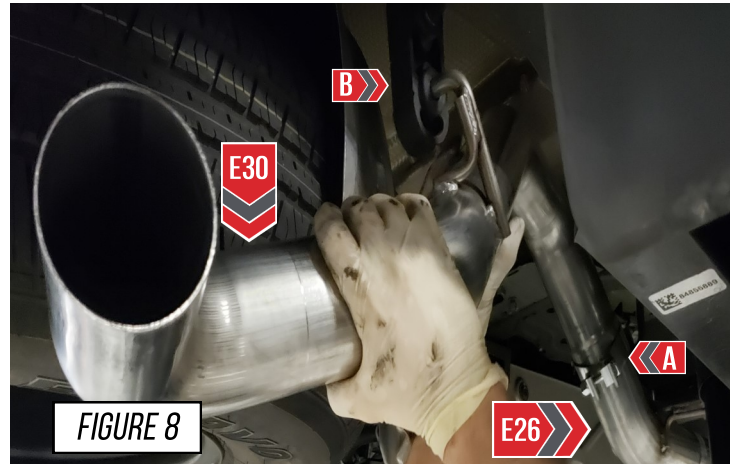

FIGURE 8

STEP 9

Install your AWE tip outlet section (**C17**), onto the AWE single exit tube (**E30**) as shown in **Figure 9**.

Ensure the C17 is parallel with the body line of the bumper.



The C17 tip merge is symmetrical so top versus bottom orientation does not matter.

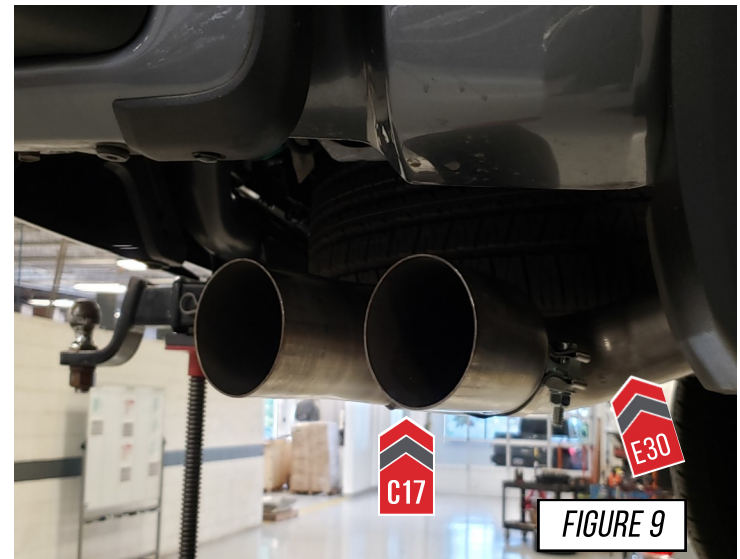

FIGURE 9

STEP 10

To install the exhaust tips with integrated clamps, first, attach the exhaust tip in the proper orientation onto the exhaust outlet tube.

Insert one of the carriage bolts from the hardware kit (**3910-41010**) through the tab on the exhaust tip and thread on one of the corresponding nuts.

Using anti-seize on the bolt threads will help installation and prevent breakage of hardware.



This exhaust system only has 2 exhaust tips while the integrated clamp kit has enough hardware for our 4 tip exhaust systems. You will have 2 sets of hardware left over that will not be used.

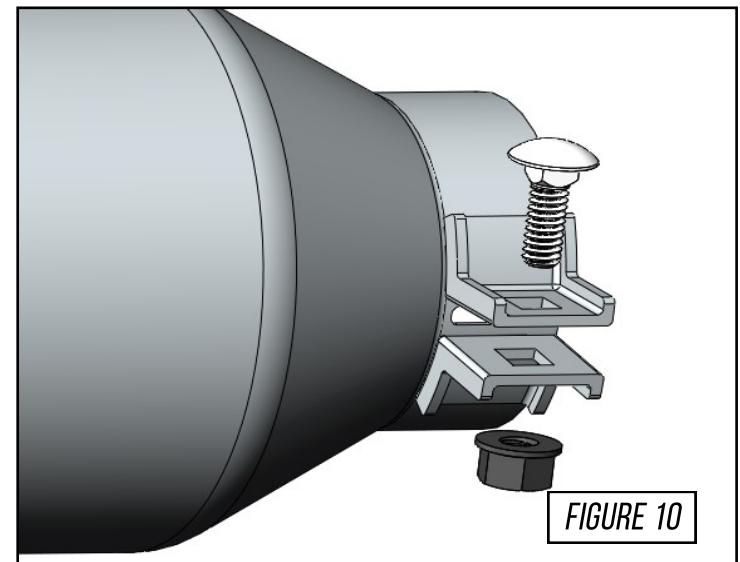

FIGURE 10

STEP 11

To install the exhaust tips, use the remaining two 3" exhaust clamps and slide them onto the tip merge before installing the exhaust tips.



Note: Exhaust tips should be installed with the logo pointing up and the slash-cut edge of the tip running parallel with the edge of the bumper. Since the tip merge is symmetrical, one tip will be seated slightly deeper on the tip merge.

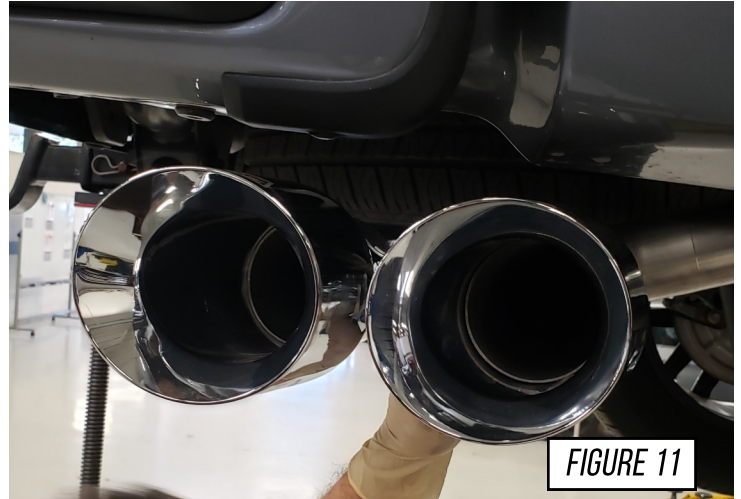

STEP 12

Install the provided exhaust hanger split collar clamps. Use the included hex wrench to help keep the exhaust system aligned and secure. Install these clamps on each hanger bar of the AWE overaxle inlet tube (E26), as shown at (A) in **Figure 12**.



STEP 13

Go through and adjust the joints so the slip fit joints are fully bottomed and there are no gaps. Confirm there is no contact to any braces, heat shielding or the chassis of the vehicle

When the exhaust is in the correct orientation, tighten all exhaust clamps to a **minimum of 60 ft-lbs** and the installation is complete.

It is now recommended to drive the car to allow the exhaust to heat cycle after all clamps and tips are fully tightened.



At this point the exhaust will be **very hot**, allow to cool before work continues.

Check the tips for correct alignment, adjust as needed.



Don't forget to look below for any troubleshooting needs!

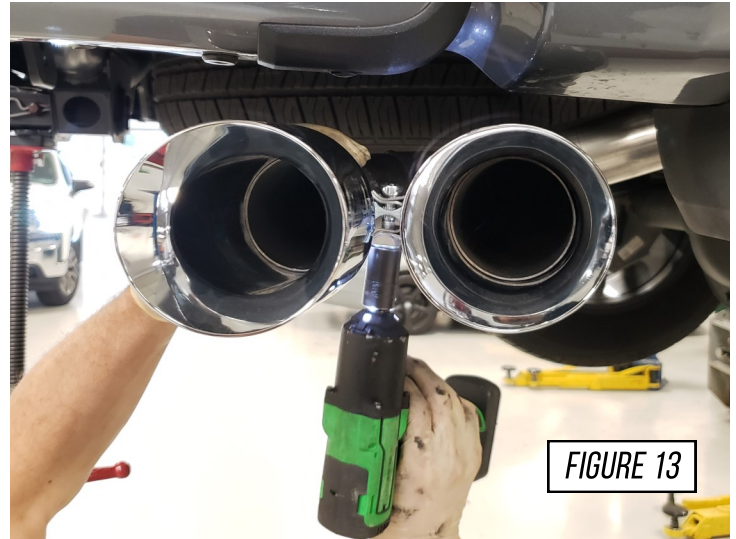

ENJOY!





STEPS 14-19 ARE FOR DUAL EXIT SYSTEMS ONLY



STEP 14

Before the rear axle tubes can be installed, the 2 new AWE hangers (E07) must be installed on the driver side and passenger side frame rails.

Start by placing the hanger bracket (E07) on the frame rail. The driver side hanger (A), shown in **Figure 14-1** will face the cab, the passenger side hanger (B) shown in **Figure 14-2** will face the rear bumper.

Using the provided hardware, slide a washer onto the bolt, and slide the bolt through the hole on the hanger (C). On the backside, place a nut on the bolt and tighten it fully.

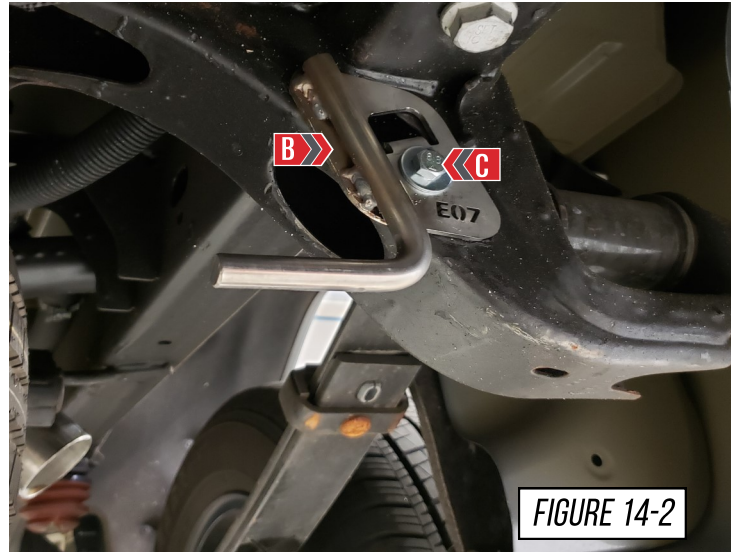
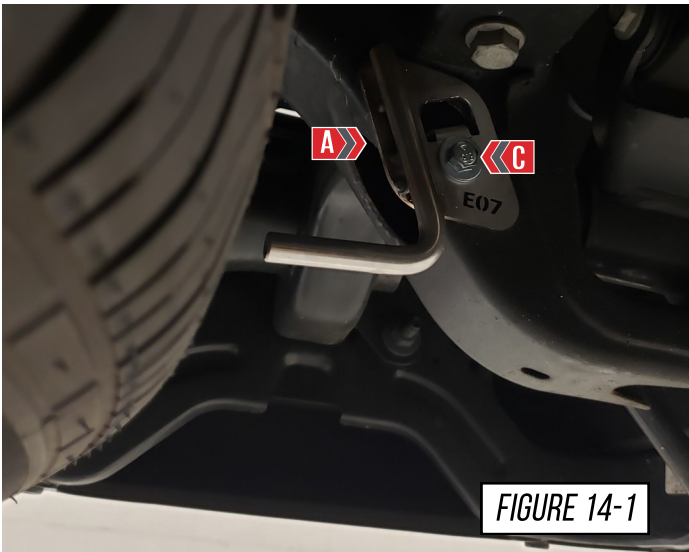

STEP 15

Install your AWE overaxle tri-section (E27). Slide a provided clamp over the slip joint, you want to make sure the driver's side leg (A) is parallel with the bed of the truck, as shown in **Figure 15**.

Note: Snug the clamp on the joint but do not fully tighten at this time.

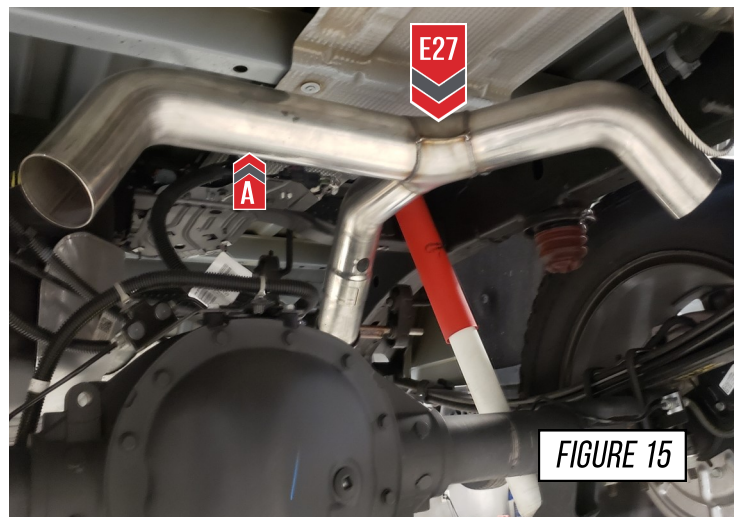

STEP 16

Install your AWE driver side tailpipe (**E31**). Start by sliding a provided clamp over your tailpipe and bottoming it out on the overaxle tri-section (**E27**). Then slide the hanger bar into the AWE rubber hanger on the AWE hanger bracket (**E07**), as shown at (**A**) in **Figure 16-1**.

Next install your passenger side tailpipe (**E32**) slide a provided clamp over your tailpipe and bottom it out on the overaxle tri-section (**E27**). Then slide the hanger bar into the AWE rubber hanger on the AWE hanger bracket (**E07**), as shown in (**B**) **Figure 16-2**.

 **Note:** While installing the AWE dual exit system, the OE side exit exhaust hanger will not be used. It can be removed while installing the passenger side tailpipe (**E32**), so it will not be in the way of the AWE system.

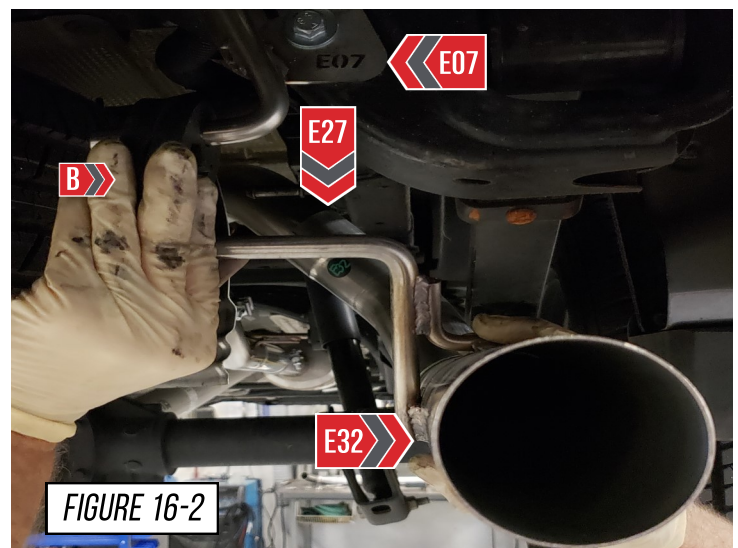
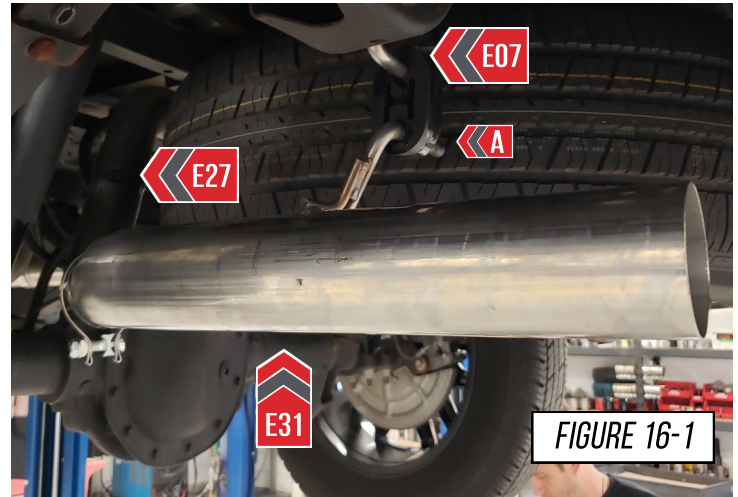

STEP 17

For the best tip fitment, align the Accu-seal clamp to cover *only* the slot, shown by **Arrow A**

Torque the tip clamp to a minimum of 60 ft./lbs.

-  **NOTES:**
- It is required to apply anti-seize to the threads to prevent thread binding, shown by **Arrow B**
 - It is okay to have the clamp extend beyond the edge of the tip inlet.

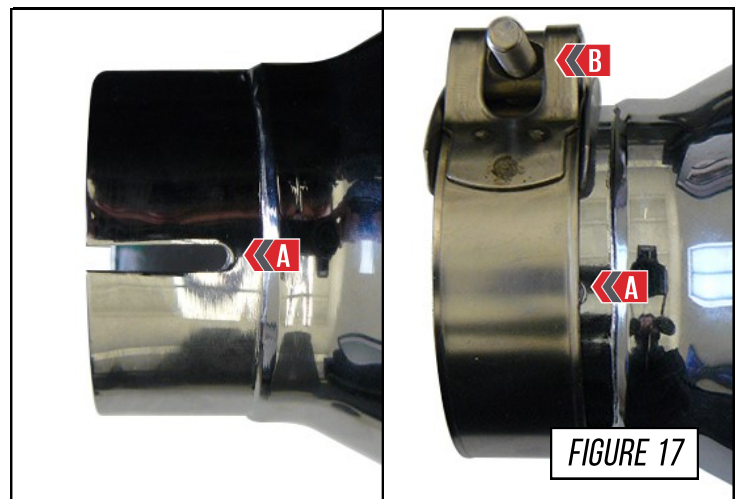

STEP 18

Gather your AWE tips to install on the tailpipes. First slide a provided clamp on each tip. Then slide the tips over each tailpipe, with the logo facing up to the desired depth. Once the desired depth is set tighten the clamps, as shown at (A) in **Figure 18-1** and **Figure 18-2**.

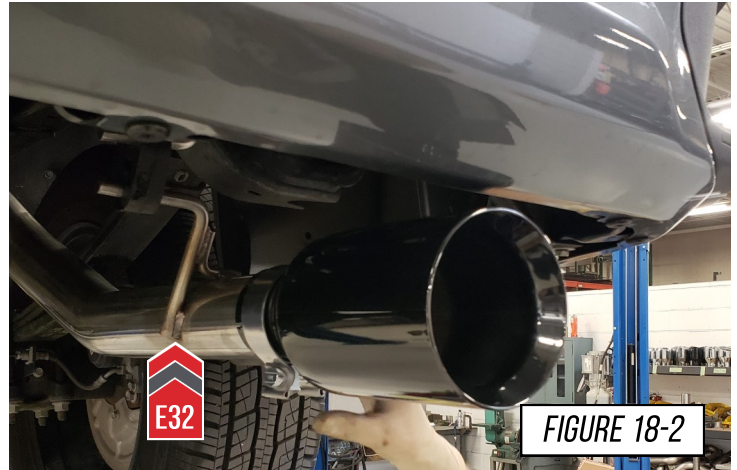

STEP 19

Install the provided exhaust hanger split collar clamps. Use the included hex wrench to help keep the exhaust system aligned and secure. Install these clamps in the orientation for the driver side shown in **Figure 19-1**, and the passenger side **Figure 19-2**.

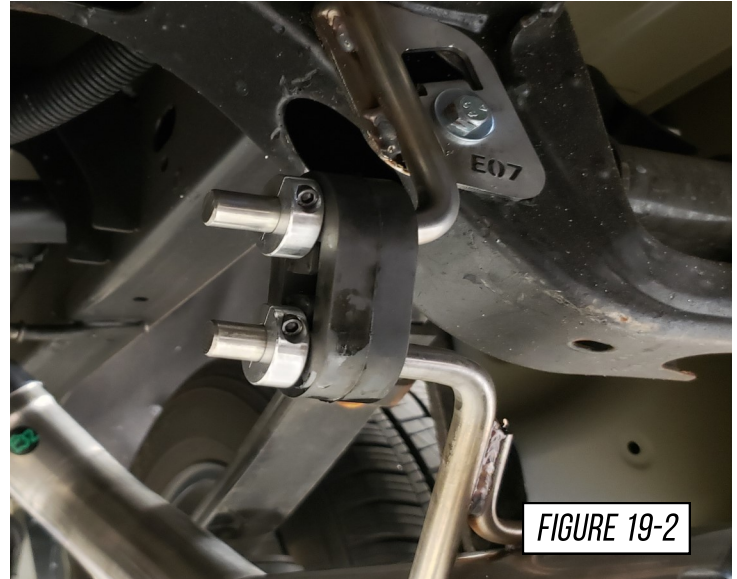
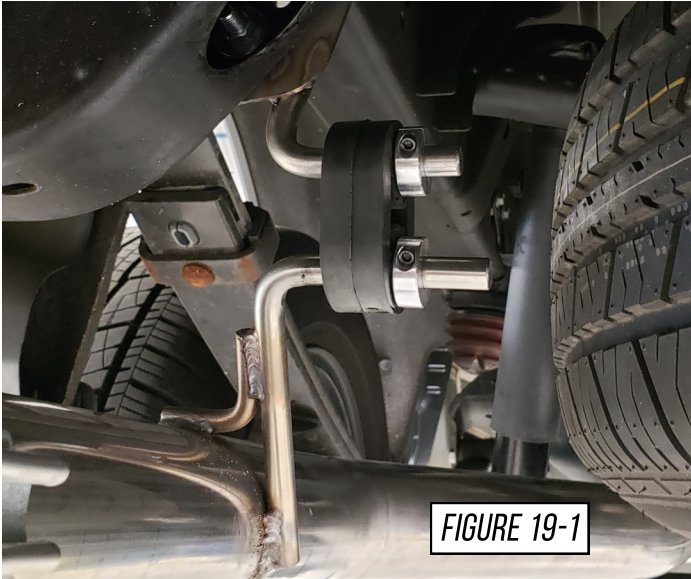

STEP 20

Make your final adjustments to the tips to ensure they are in a position you like. Once the desired positioning is achieved, fully tighten down all clamps.

It is now recommended to drive the car to allow the exhaust to heat cycle after all clamps and tips are fully tightened.



At this point the exhaust will be **very hot**, allow to cool before work continues.

Check the tips for correct alignment, adjust as needed.



Don't forget to look below for any troubleshooting needs!



ENJOY!





STEPS 21-28 ARE FOR QUAD EXIT SYSTEMS ONLY



STEP 21

Install your AWE overaxle tri-section (**E27**). You want to make sure the driver's side leg (**A**) is parallel with the bed of the truck, as shown in **Figure 21**.

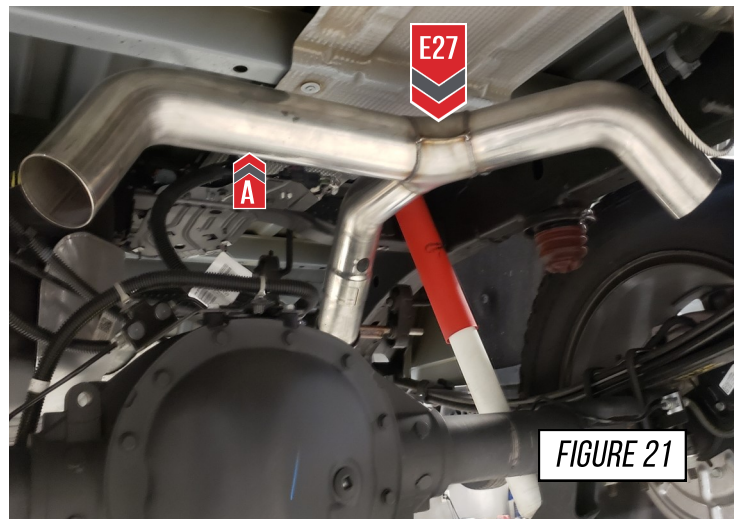

STEP 22

Install your AWE driver side tailpipe (**E28**), start by sliding a provided clamp onto the tailpipe.

Next insert the hanger bar into the OE hanger as shown at (**A**) in **Figure 22-1**. Now bottom out the slip joint on the overaxle tri-section (**E27**), as shown at (**B**) in **Figure 22-2**.

Note: Snug the clamp on the joint at this time, but do not fully tighten it.

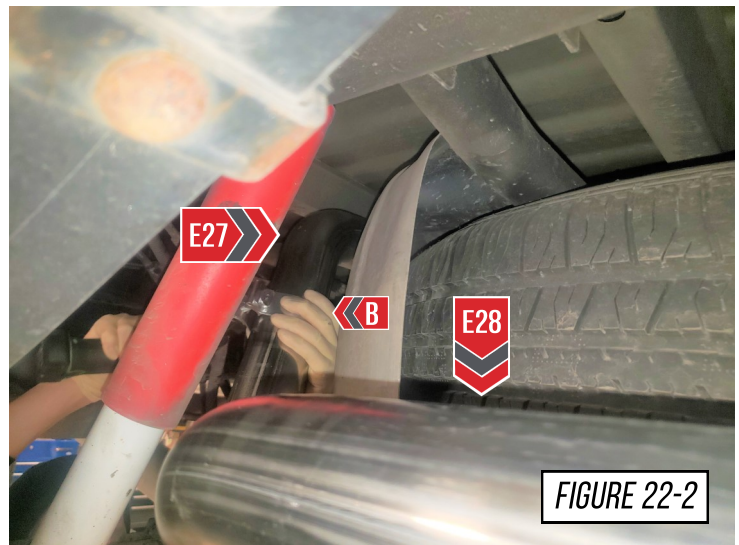

STEP 23

Install your AWE passenger side tailpipe (E29), by first inserting the hanger bar into the OE hanger, as shown at (A) in **Figure 23-1**. Next bottom out the slip joint on the overaxle tri-section (E27), as shown at (B) in **Figure 23-2**.

Note: Snug the clamp on the joint but do not fully tighten it.

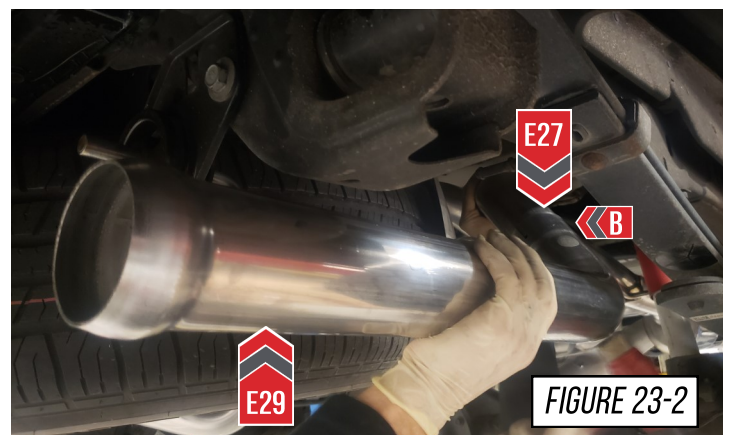
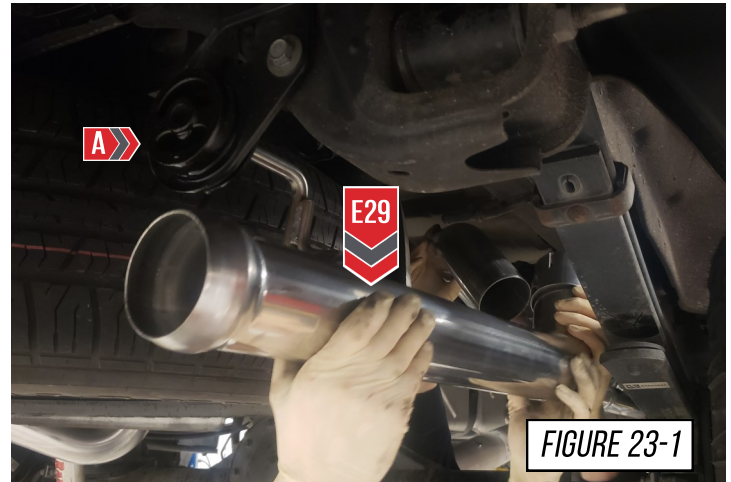

STEP 24

Install your 2 AWE quad tip outlets (E31), using the provided ball socket clamps to secure the tip outlets in place, as shown in **Figure 24-1**, and **Figure 24-2**.

Note: Do not fully tighten the tip outlet sections, as they may need to be adjusted.

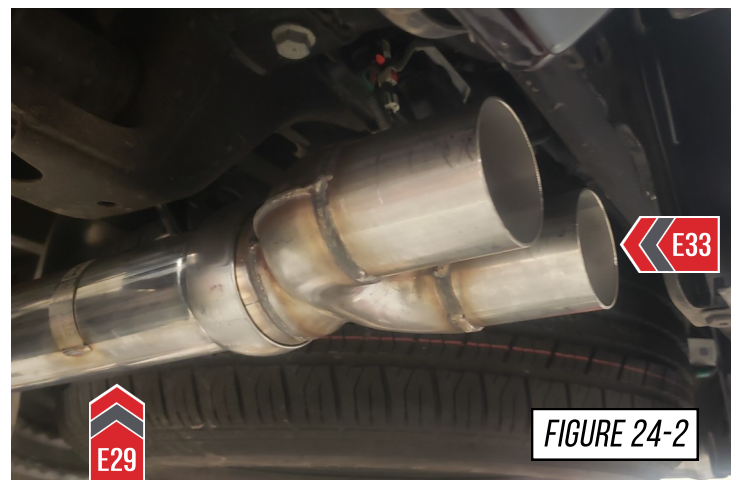
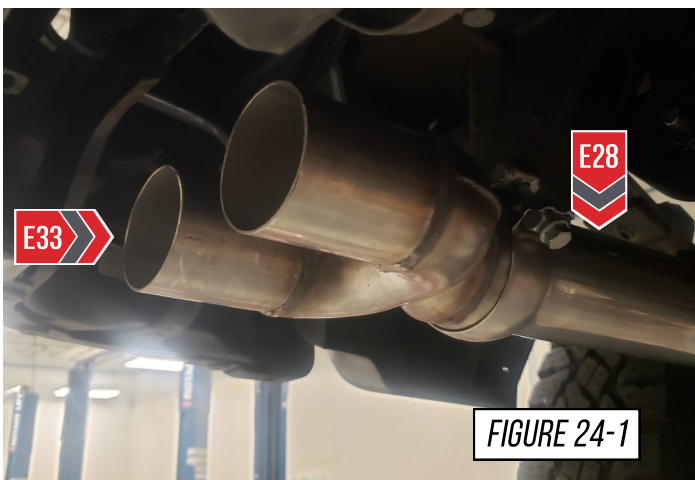

STEP 25

To install the exhaust tips with integrated clamps, first, attach the exhaust tip in the proper orientation onto the exhaust outlet tube.

Insert one of the carriage bolts from the hardware kit (**3910-41010**) through the tab on the exhaust tip and thread on one of the corresponding nuts.

Using anti-seize on the bolt threads will help installation and prevent breakage of hardware.

 This exhaust system only has 4 exhaust tips while the integrated clamp kit has enough hardware for our 4 tip exhaust systems. You will have 2 sets of hardware left over that will not be used.

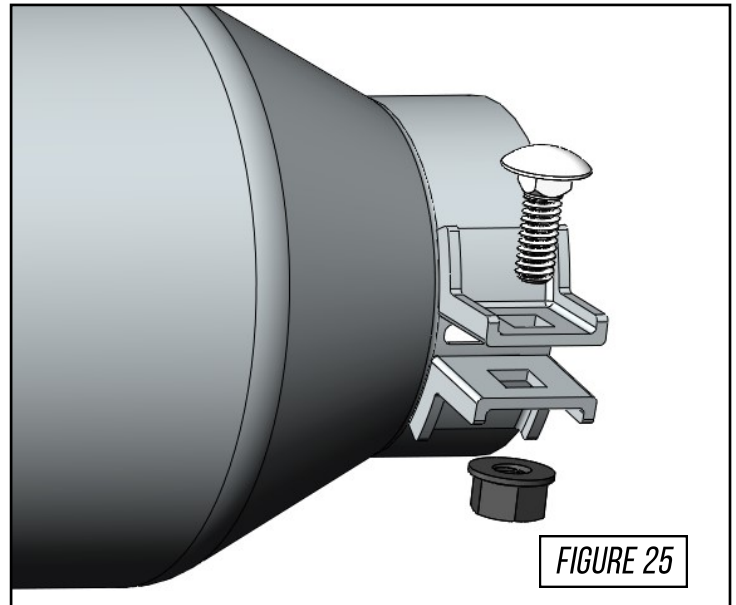

STEP 26

Gather your four AWE exhaust tips, slide them on to the tip outlet sections and orient them so the AWE logo is facing up. Using the provided integrated clamp hardware kit snug the tips down but do not fully tighten to allow for final adjustments.

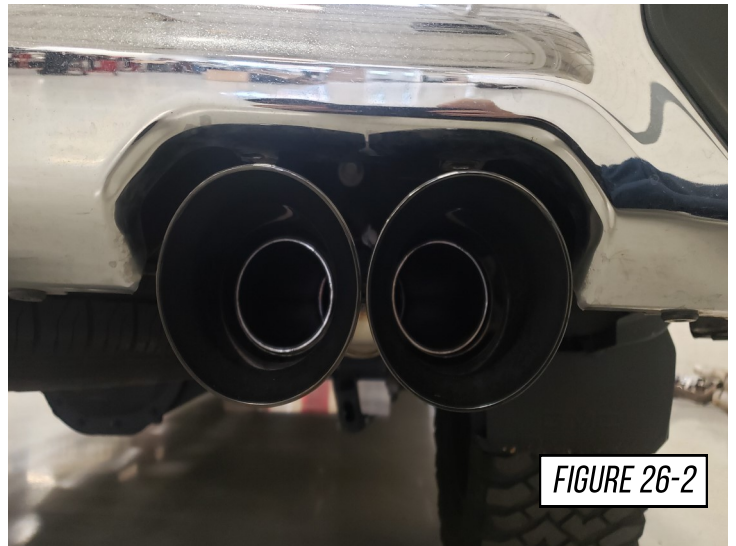
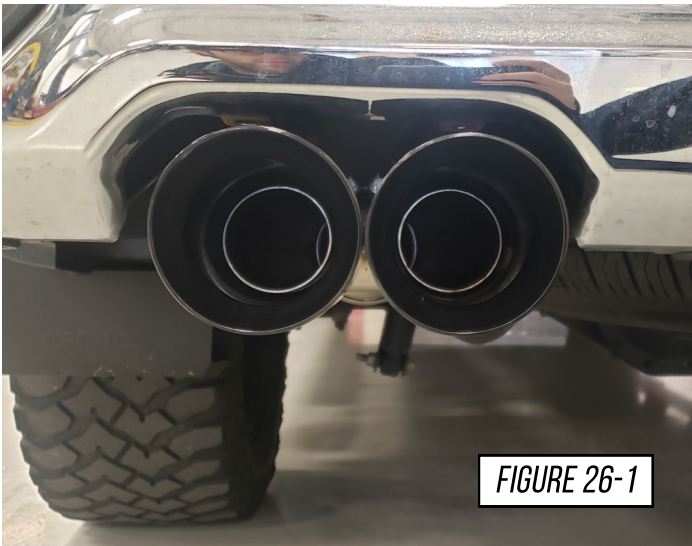

STEP 27

Install the provided exhaust hanger split collar clamps. Use the included hex wrench to help keep the exhaust system aligned and secure. Install these clamps on each hanger bar of the AWE overaxle inlet tube (**E26**), as shown at (**A**) in **Figure 27**.



STEP 28

Make your final adjustments to the tips to ensure they are in a position you like. Once the desired positioning is achieved, fully tighten down all clamps.

It is now recommended to drive the car to allow the exhaust to heat cycle after all clamps and tips are fully tightened.

 At this point the exhaust will be **very hot**, allow to cool before work continues.

Check the tips for correct alignment, adjust as needed.

 Don't forget to look below for any troubleshooting needs!



ENJOY!



TROUBLESHOOTING

Issue	Solution
Exhaust is not fitting correctly	Most fitment issues are due to improperly adjusted exhaust. This includes tip fitments and rattling due to chassis contact. Check out our fitment guide for more installation tips.
Incorrect or missing parts	Double check the parts list for your system and compare them with what you received. Fill out our contact form, found below and let us know what parts you need.

CARE

Once installed properly, your AWE exhaust will provide years of trouble-free performance.

The exhaust volume and sound will settle with usage; 800-1000 miles is required to break-in new exhaust systems.

Also, please note that the rear **180Technology**[®] resonator has a small drain hole to allow condensation to escape. Water drops from this area are normal.

Periodic cleaning of exhaust tips is necessary to maintain proper finish, especially in areas prone to road salt and caustic deicing solutions. Use a mild soap and water solution or car wax to clean the finish. Avoid using abrasive polishes, as they can scratch the finish.

Any questions or comments,
please do not hesitate to contact us:

AWE
215-658-1670
[CONTACT FORM](#)

WARRANTY

Up-to-date warranty information is found [HERE](#).