

ARMS **BX8270 KA24DE**

P/N | TB403A-NS16D

TURBOCHARGER SPECIFICATION SHEET

COMPRESSOR

コンプレッサーホイール
COMPRESSOR WHEEL

㊤入口径 IND (mm)	㊦外径 EXD (mm)	トリム TRIM	ブレード数 BLADES	材質 MATERIAL	製法 PRODUCTION
59.0	76.2	60	6/6	A2618	CNC削出 CNC BILLET

コンプレッサーハウジング
COMPRESSOR HOUSING

入口径 IND (mm)	外径 EXD (mm)	A/R
60.0	38.75	0.62

センターカートリッジ
BEARING TYPE

ボールベアリング
BALL BEARING

TURBINE

タービンホイール
TURBINE WHEEL

㊥出口径 EXD (mm)	㊧外径 IND (mm)	トリム TRIM	ブレード数 BLADES	材質 MATERIAL	製法 PRODUCTION
58.8	67.0	77	9	K418	鋳造 CAST

タービンハウジング
TURBINE HOUSING

入口 IND	出口 EXD	A/R
T25	SR20DET	0.57

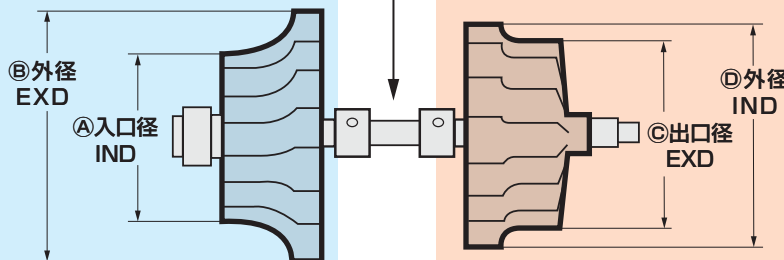

初期設定過給圧
INITIAL BOOST SETTING

1.0kgf/cm²

⚠ ブースト圧設定時のご注意

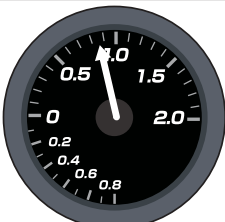
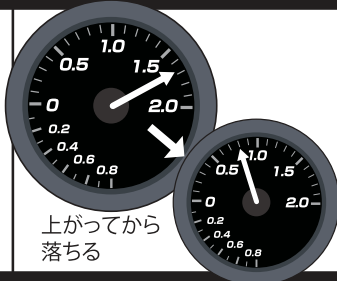
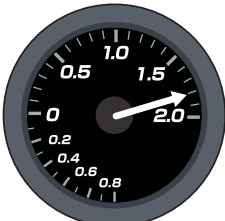
アクチュエーター スプリング	ブースト コントローラー		エンジンへの 負荷	パワー	ブースト	こんな方へ	
標準	OFF	 設定値以上上がらない	○	△	安定度	立ち上がりが遅い 高回転時に垂れる	街乗り中心 ・エンジン強化無し ・パワーアップよりも エンジンを大事したい
					調整	不可能	
標準	ON	 上がってから 落ちる	△	○	安定度	高回転時に垂れる	サーキット走行をする ・必要な時にパワーを上げたい ・最低限のエンジン強化済み ・水温・油温対策済み
					調整	可能	
強化	ON	 下げたくても下がらない	×	◎	安定度	立ち上がり・ 高回転時ともに良い	ドラッグレース・ 本格的なサーキット走行 ・エンジン強化済み ・水温・油温対策済み ・エンジンに詳しい
					調整	可能だが スプリング設定 以下には 下げられない	

ブースト圧の設定はブーストコントローラーで行ってください。

⚠ BOOST SETTING CAUTION

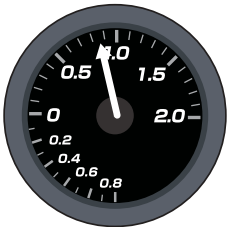
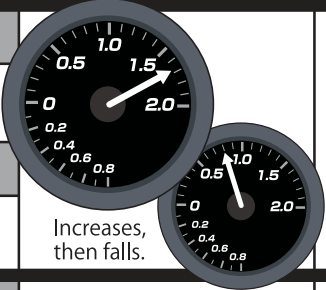
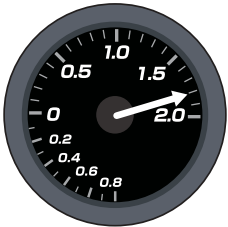
		STRESS ON ENGINE	POWER	BOOST	GOOD FOR
ACTUATOR SPRING	 <p>Doesn't exceed preset.</p>	LIGHT	GOOD	CHARACTERISTICS	STREET
DEFAULT				Slow spool, fall-off at high rpm.	
BOOST CONTROLLER				ADJUSTABILITY	
OFF				NONE	
ACTUATOR SPRING	 <p>Increases, then falls.</p>	MILD	GREAT	CHARACTERISTICS	TRACK
DEFAULT				Fall-off at high rpm.	
BOOST CONTROLLER				ADJUSTABILITY	
ON				YES	
ACTUATOR SPRING	 <p>Cannot be lowered beyond preset.</p>	HEAVY	HIGH!	CHARACTERISTICS	DRAG/ PRO RACE
UPGRADED				Good spool, good high rpm performance.	
BOOST CONTROLLER				ADJUSTABILITY	
ON				YES but will not fall below preset spring pressure.	

**ALWAYS USE A BOOST CONTROLLER
TO CONFIGURE BOOST SETTINGS**

TOMEI
The Engine Specialist

KA24DE
Empowered
KA24DET

KA24DE TURBO GUIDE

INSTALLATION MANUAL

The following products have been developed by TOMEI USA to provide a simple yet powerful solution for turbocharging the naturally aspirated KA24DE engine.

- > EXHAUST MANIFOLD KIT EXPREME KA24DE S13/S14 TURBO TYPE
- > TURBOCHARGER KIT ARMS BX7960 / BX8270 KA24DE
- > TURBOCHARGER KIT ARMS KA24DE HARDWARE PACK
- > INTERCOOLER PIPING KIT KA24DE

When combined, these products and parts empower the KA24DE with the same exhaust-side layout as the SR20DET engine, allowing users to install a variety of readily-available SR20DET turbo parts.

All the above products come complete with the necessary hardware for installation including nuts, bolts, gaskets and fitting adapters, with only a few simple modifications required by the user.

In addition to the instructions for installing these products, this guide also contains useful information and advice for a smoother install.

Please ensure you also refer to the official Nissan Servicing Manual.

After installation, keep this document stored in a safe location for future reference.

Retailers and/or workshops should pass this document to the end user and/or customer.

03	1. PRODUCT INFO
05	2. REMOVING THE STOCK COMPONENTS
16	3. PARTS/SYSTEM LAYOUT
19	4. INSTALLING THE TURBOCHARGER KIT, TURBO EXHAUST MANIFOLD AND TURBO OUTLET/ELBOW
	4.1. PARTS AND COMPONENTS
	4.1.1. TURBOCHARGER KIT
27	4.1.2. TURBO EXHAUST MANIFOLD
29	4.2. MODIFICATIONS
	4.2.1. ENGINE MOUNT BRACKET (LH)
30	4.2.2. OIL PAN
31	4.3. PREPARING AND REINSTALLING THE OIL PAN
32	4.4. REINSTALLING THE STOCK COMPONENTS
33	4.5. INSTALLING THE TURBO EXHAUST MANIFOLD AND TURBO OUTLET/ELBOW
	4.5.1. PREPARING THE TURBOCHARGER
	4.5.2. PREPARING THE EXHAUST MANIFOLD
34	4.5.3. ASSEMBLING THE TURBOCHARGER, TURBO EXHAUST MANIFOLD AND TURBO OUTLET/ELBOW
35	4.6. INSTALLING THE TURBOCHARGER HOSES, TUBES AND PIPES
	4.6.1. WATER OUT HOSE
36	4.6.2. WATER IN HOSE
37	4.6.3. OIL IN HOSE
38	4.6.4. OIL DRAIN PIPE
	4.6.5. HEAT RESISTANT HOSE
39	4.6.6. WATER IN HOSE ADAPTER (to cylinder block)
	4.6.7. COMPRESSOR INLET ELBOW PIPE
40	4.6.8. COMPRESSOR OUTLET ELBOW PIPE
41	4.7. INSTALLING THE COMPONENTS ONTO THE ENGINE
	4.7.1. OIL IN FROM PRESSURE SENSOR
42	4.7.2. WATER IN FROM CYLINDER BLOCK
43	4.7.3. WATER OUT TO UPPER RADIATOR HOSE
44	4.7.4. TURBOCHARGER ASSY
45	4.7.5. HOSES
49	4.8. OTHER
	4.8.1. REATTACHING THE STEERING SHAFT
	4.8.2. (RE)INSTALLING EXHAUST COMPONENTS
	4.8.3. EGR BLIND PLUG
50	4.8.4. INSTALLING AN AIR INTAKE
51	5. INSTALLING THE INTERCOOLER PIPING KIT
	5.1. PARTS AND COMPONENTS
53	5.2. INSTALLING THE GREDDY INTERCOOLER KIT
54	5.3. INSTALLING THE INTERCOOLER PIPING KIT
	5.3.1. INTAKE PIPE A
55	5.3.2. INTAKE PIPE B
56	5.3.3. BLOW-BY HOSE
	5.3.4. INTERCOOLER
57	6. POST INSTALLATION
	6.1. FILL ENGINE OIL
	6.2. (RE)CONNECT BATTERY
	6.3. REFILL COOLANT AND 'BLEED' SYSTEM
58	7. CHECKS AND PRECAUTIONS
59	8. SETUP AND SETTINGS
	8.1. TURBOCHARGER SPECIFICATIONS
60	8.2. ACTUATOR SPRINGS
62	8.3. ADDITIONAL/RECOMMENDED PARTS
	8.3.1. TOMEI PARTS
64	8.3.2. OTHER PARTS
	8.3.3. OPTIONAL PARTS DEPENDING ON SETUP
65	9. TOMEI 240SX KA24DET SPECIFICATIONS

1. PRODUCT INFO



TURBOCHARGER KIT

BX7960 / BX8270 KA24DE

BX7960 PART No. TB403A-NS16C

BX8270 PART No. TB403A-NS16D

APPLICATION: NISSAN 240SX S14 KA24DE

※ This kit is comprised of the TURBOCHARGER and KA24DE HARDWARE PACK.



TURBOCHARGER KIT

KA24DE HARDWARE PACK for BX

for BX PART No. TB403A-NS16PK

APPLICATION: NISSAN 240SX S14 KA24DE

※ KA24DE HARDWARE PACK ONLY.



EXHAUST MANIFOLD KIT

KA24DE S13/S14 TURBO TYPE

PART No. TB601A-NS16A

APPLICATION: NISSAN 240SX S14 KA24DE



INTERCOOLER PIPING KIT KA24DE

PART No. TB410A-NS16A

APPLICATION: NISSAN 240SX S14 KA24DE

WARNING

- Make sure the engine is cold before conducting any work on the vehicle. This is to avoid burn potential hazards and failing to adhere to this can be extremely dangerous.
- Ensure you use the appropriate tools and safety equipment to avoid injury during installation.
- Ensure that all parts are fitted correctly during installation. This is to avoid potential fire hazards and/or damage to not only your vehicle but also the vehicles around you.

CAUTION

- This document contains instructions on how to install the TURBOCHARGER, TURBO EXHAUST MANIFOLD and INTERCOOLER PIPING KIT. For details on the removal/installation of factory components as well as general maintenance information, please consult the manufacturer's official servicing manual.
- These products are designed specifically for motorsport use. As such, it should only be used off-road and/or on race tracks/circuits closed off from public roads.
- The engine's output will increase after installing the above products. Accordingly, the brakes, suspension, ECU as well as other surrounding components will also need to be upgraded and/or adjusted. These upgrades will need to be purchased separately and will depend on your particular setup.
- These products can/should only be used on the specified vehicle(s) or engine(s). Attempting to install these on any other vehicle will likely result in damage to the product and/or the engine/vehicle.
- To install the TURBO ASSY, TURBO EXHAUST MANIFOLD and INTERCOOLER PIPING KIT, you will need to make some modifications to the surrounding components. Ensure you familiarize yourself with the process and have the appropriate tools to hand before commencing any work.
- These products should be installed by a trained professional in a well equipped workshop.
- Take extra care when removing components as using excessive force can damage the part(s).
- Each bolt should be tightened down to using the specified amount of torque. Failing to do so could cause the bolt to warp and/or break.
- After installation, ensure that the engine has sufficient coolant and conduct a thorough check for leaks *before* driving the vehicle. Do *not* attempt to drive the vehicle when there is a leak or insufficient coolant. This can cause the engine/water temperature to rise, leading to engine damage.
- Be sure to install a boost gauge to monitor the turbo's performance.

REQUIRED TOOLS The following tools are required for installation.

- | | | |
|------------------------------------|-----------------------------|-------------------------|
| • General engine maintenance tools | • Official Servicing Manual | • Liquid gasket |
| • Torque wrench | • Safety equipment | • Thread seal tape |
| • Drill or drill press | • Grinder | • Coolant |
| • Center drill | • Paint | • Engine oil |
| • 10mm & 16.5mm drill bit | • Engine crane | • Silicone hose (Ø8mm)* |

* The Silicone hose may or may not be required depending on the setup. In this guide, the hose is used in step 5.3.1. to connect a boost controller.

2. REMOVING THE STOCK COMPONENTS

CAUTION

This manual provides only the basic instructions.
For details, please refer to the vehicle's official servicing manual.

1. Disconnect and remove the battery.



※ a modified 240SX may look slightly different but fundamentally the same components will need to be removed.

2. Remove the engine under cover.



3. Remove the hood.

4. Remove the air intake ASSY (pre-throttle body).

5. Remove the exhaust (front, center and rear sections).

6. Disconnect the steering shaft.

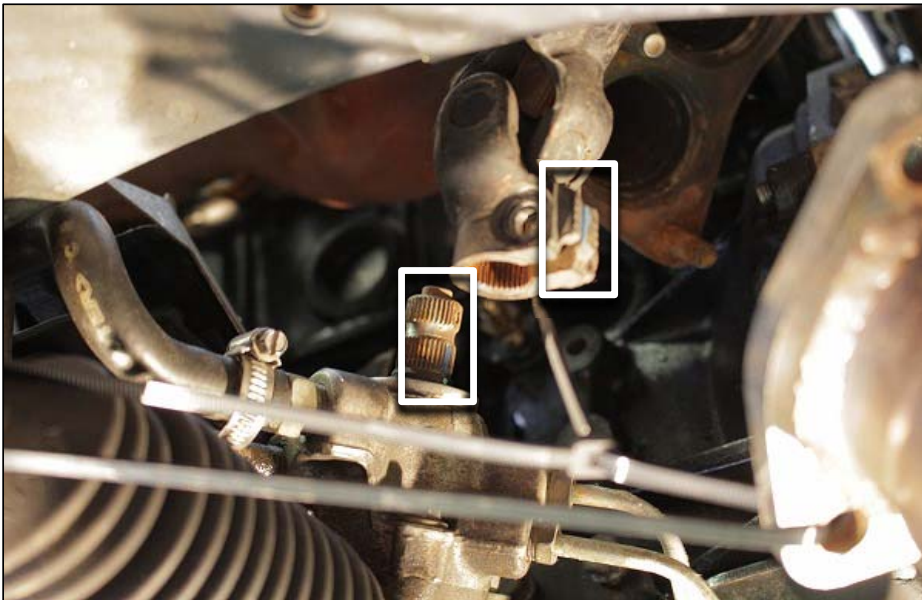

With the steering wheel centered, carefully mark the steering shaft U-joint position in relation to the steering rack pinion gear this is to ensure correct steering alignment upon reinstall. Then, loosen the upper bolt on the U-joint and completely remove the lower bolt to disconnect the steering shaft.

7. Remove the exhaust manifold.

8. Drain the engine oil and coolant.

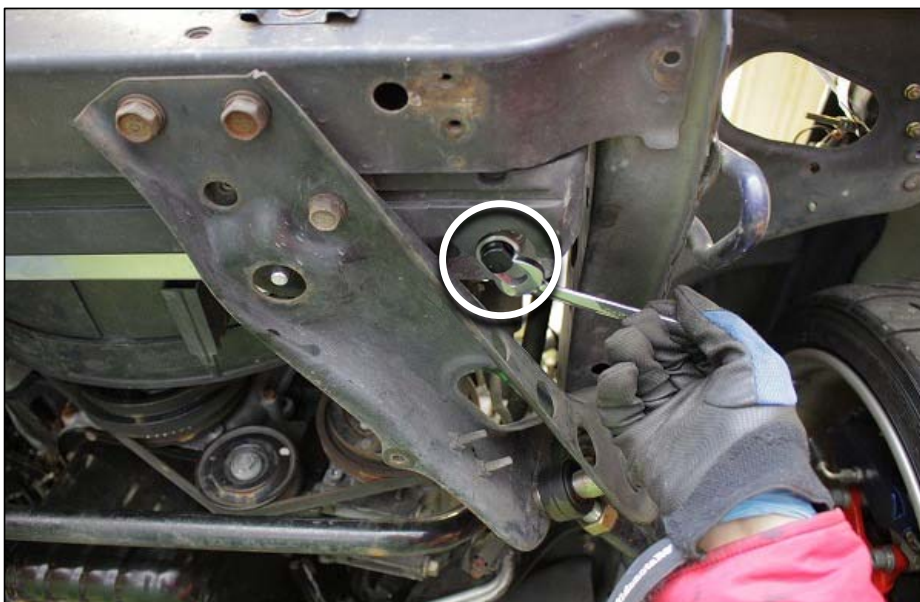
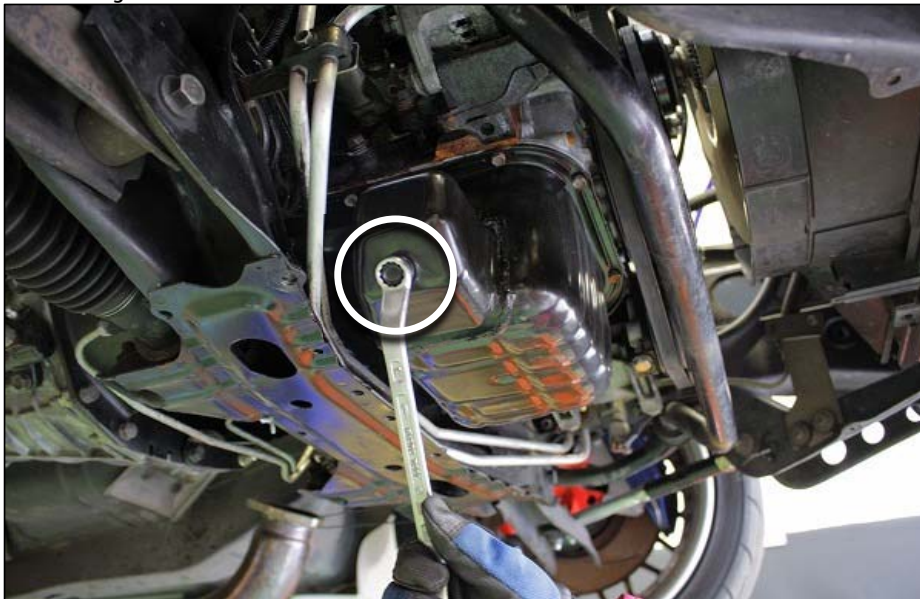

Remove the drain plug on both the oil pan and radiator to drain the engine oil and coolant.

9. Remove the oil filter and oil pressure sensor.

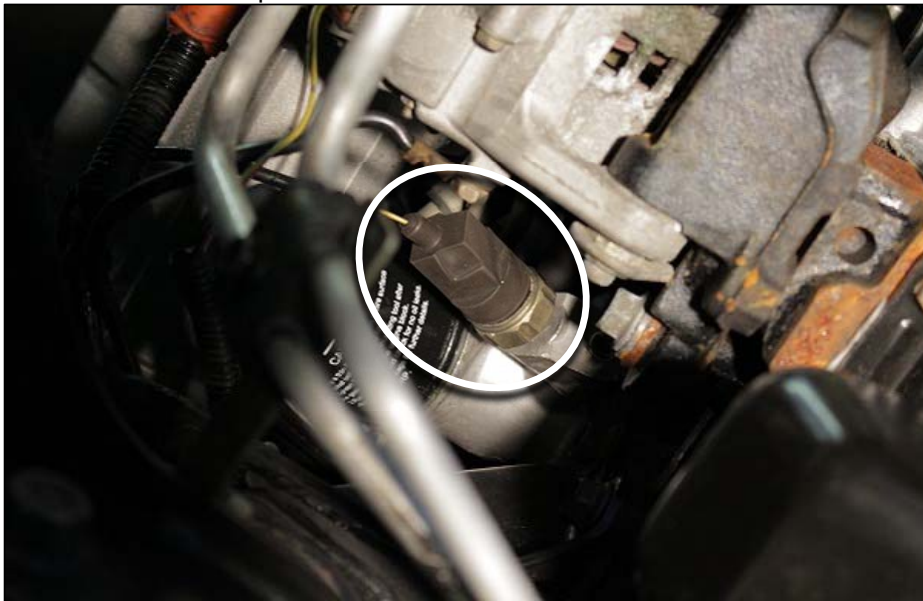

The oil pressure sensor will be reused later.

※ Removing the oil filter makes access to the oil pressure sensor a lot easier.

10. Remove the coolant drain bolt on the cylinder block.

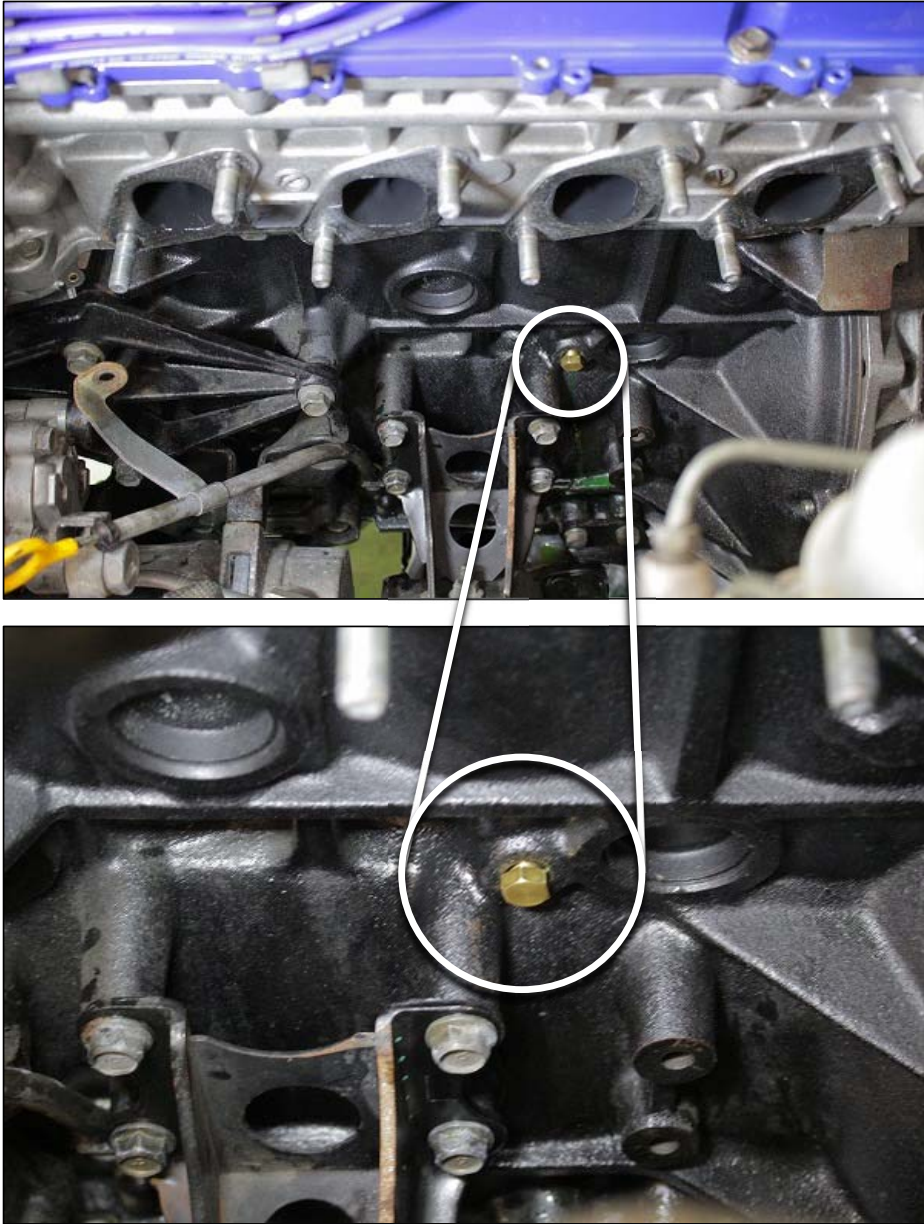

※ This hole will later be used for the turbocharger WATER IN FITTING.

11. Remove the radiator and radiator fan shroud.



Carefully remove the radiator and radiator fan shroud from the engine bay.
Depending on your setup, you may need to remove these separately.

※ A modified 240SX may look slightly different but fundamentally the same components will need to be removed.

12. Remove the front stabilizer bar.

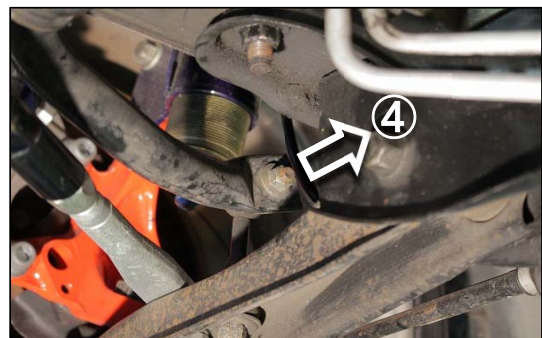
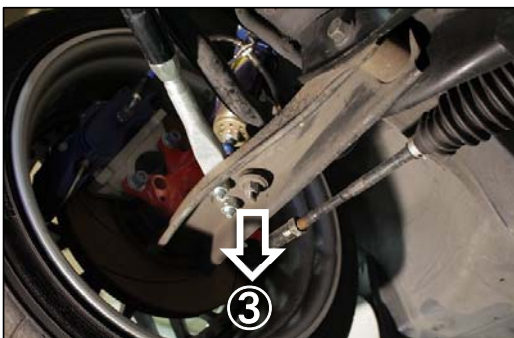
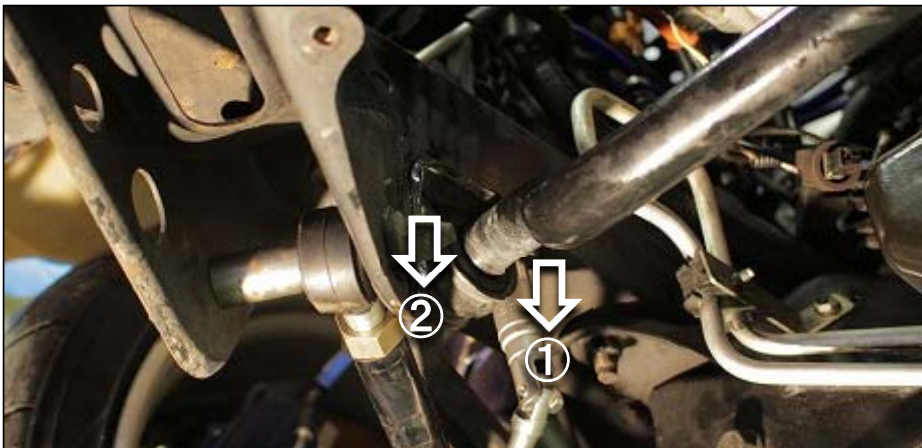
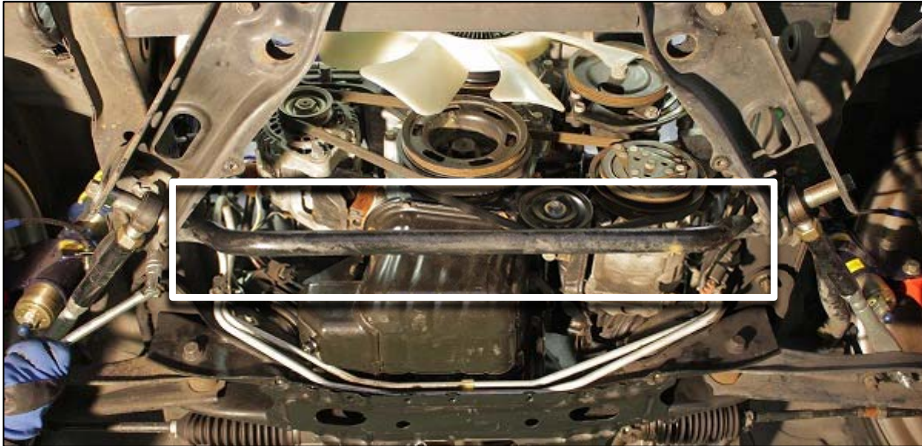

- Remove the 4 bolts/nuts for both the left and right side of the stabilizer bar. (Right side shown above)
- ※ Removing the stabilizer bar ensures sufficient clearance for the oil pan to be lowered and removed.
 - ※ A modified 240SX may look slightly different but fundamentally the same components will need to be removed.

13. Remove the A/C belt.

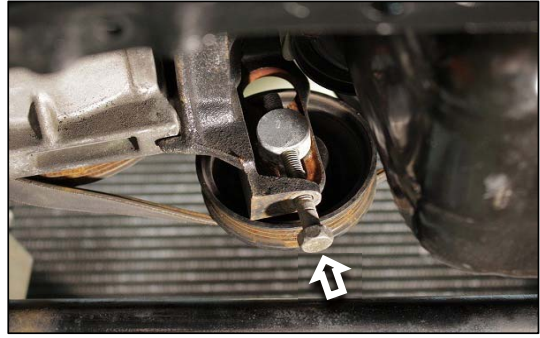

Loosen the center bolt on the AC idler tension pulley, then relieve the tension on the belt to unmount it from the pulley.

※ Removing the AC belt ensures sufficient clearance for the oil pan to be removed.

14. Remove both the right and left transmission/engine gussets.

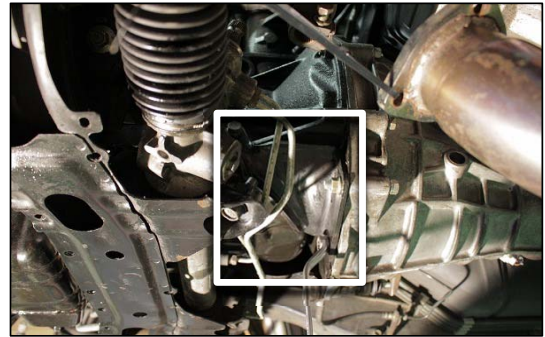

※ The gussets need to be removed so that the oil pan can be detached.

15. Secure the engine using an engine crane.



16. Remove the lower engine mount bolt/nut from the left and right engine mounts.

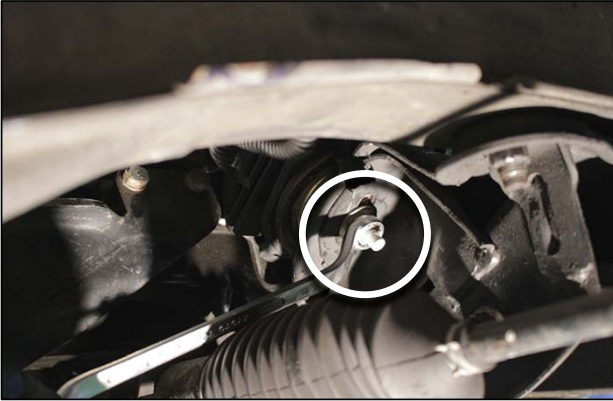

※ The lower bolt/nut needs to be removed so that the front crossmember can be lowered enough to remove the oil pan.

17. Loosen and lower the front crossmember.

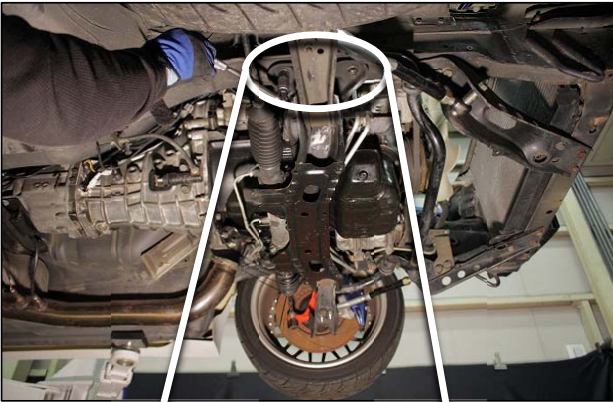

Loosen the 4 bolts/nuts holding the front crossmember in place. (left side x2, right side x2)

※ Do *not completely remove* the bolts/nuts during this process.

18. Hoist the engine and remove the LH engine mount bracket.



Ensure you have appropriate engine slingers attached to the cylinder head then hoist the engine just enough so that the LH engine mount bracket and bolts can be removed.



With the engine hoisted, carefully remove the LH engine mount bracket.

※ The LH engine mount bracket needs to be modified slightly to allow sufficient clearance for the turbocharger.

19. Carefully separate the oil pan from the cylinder block using an oil pan seal cutter.

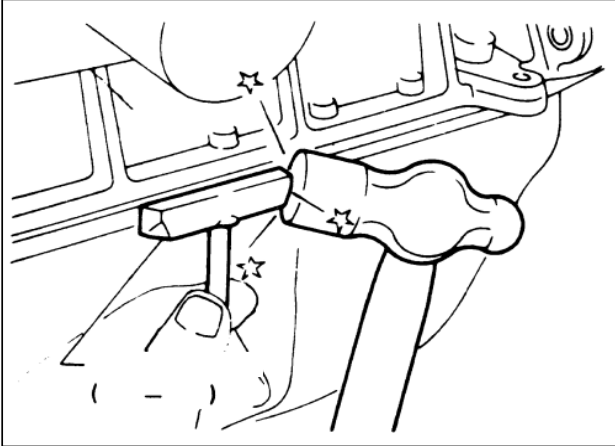

20. Disconnect the oil strainer from the cylinder block.



- ※ The oil strainer gasket will be reused when reinstalling later.
- ※ Detaching the oil strainer from the cylinder block makes removing the oil pan much easier.

21. Remove the oil pan and strainer from the vehicle.

While lowering the front cross member, carefully remove both the oil pan and oil strainer from the vehicle.

22. Clean the oil pan thoroughly.

Ensure sure you also remove and/or modify any other necessary parts.

3. PARTS/SYSTEM LAYOUT

The below diagram shows the positioning/layout of the components included in this kit. You may wish to print and have this to hand for reference during the installation.

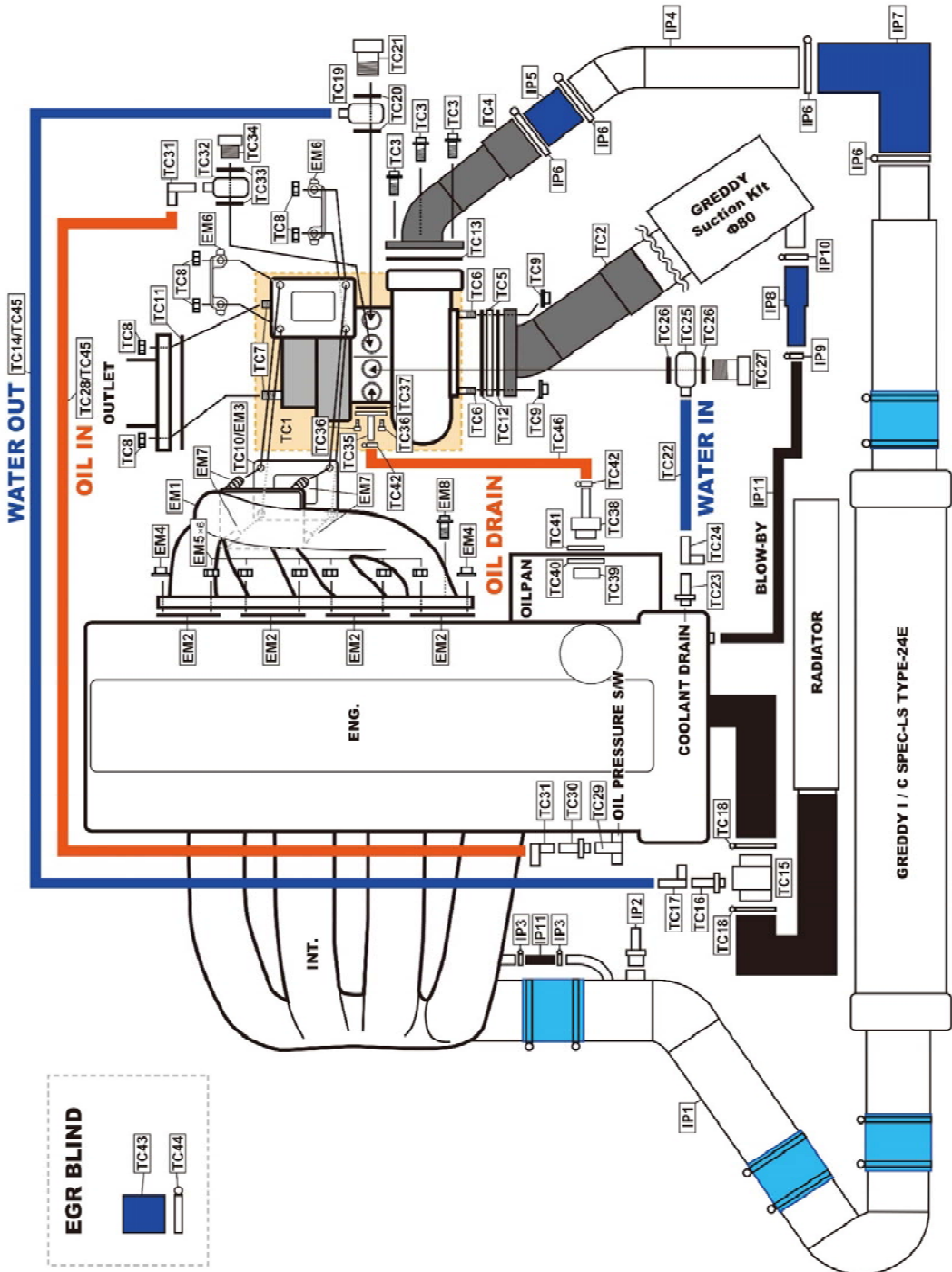

TURBOCHARGER KIT

REF.	PART	LOCATION	QTY.
TC1	TURBOCHARGER		1
TC2	COMPRESSOR IN PIPE	Compressor Housing	1
TC12	COMPRESSOR IN GASKET		2
TC5	COMPRESSOR IN ADAPTER		1
TC4	COMPRESSOR OUT PIPE	Compressor Housing	1
TC13	COMPRESSOR OUT GASKET		1
TC3	FLANGE BOLT M6		3
TC10	TURBINE IN GASKET	Turbocharger / Exhaust Housing	1
TC8	HEX NUT M8×P=1.25		4
TC6	STUD BOLT M8×P=1.25×L=35mm	Turbocharger / Compressor Housing	2
TC9	FLANGE NUT M8×P=1.25		2
TC7	STUD BOLT M8×P=1.25×L=38mm	Turbocharger / Exhaust Housing	2
TC8	HEX NUT M8×P=1.25		2
TC11	TURBINE OUT GASKET		1
TC28	MESH HOSE 940mm	Oil In / Turbo-Oil Pressure Sensor	1
TC29	3WAY ADAPTER	Oil In / Oil Pressure Sensor	1
TC30	FITTING PT1/8-AN4		1
TC31	FITTING 4AN M TO F 90°		2
TC32	BANJO FITTING M12 4AN 50mm	Oil In / Turbocharger	1
TC33	COPPER WASHER M12×D18×D12.2×T1.2		2
TC34	BANJO BOLT M12×P1.25×H25.3 1.0		1
TC35	OIL DRAIN PIPE A	Oil Out / Turbocharger	1
TC37	OIL RETURN GASKET		1
TC36	BOLT M6×P=1.0×L=16mm		2
TC38	OIL DRAIN PIPE B	Oil Out / Oil pan	1
TC39	HEX NUT M16		1
TC40	WASHER M16		1
TC41	SEAL WASHER M16		1
TC42	HOSE BAND 18-32mm		2
TC14	MESH HOSE 1350mm		Water Out / Turbo - Radiator Upper Hose
TC15	WATER PIPE ADAPTER	Water Out / Radiator Upper Hose	1
TC16	FITTING PT1/8-4AN		1
TC17	FITTING 4AN M TO F 90°		1
TC18	HOSE BAND 27-51MM		2
TC19	BANJO FITTING M14 4AN 38.5mm		Water Out / Turbocharger
TC20	COPPER WASHER M14×D21×D14×T1.0	2	
TC21	WATER BOLT M14×P1.5×27mm	1	
TC22	MESH HOSE 200mm	Water In / Turbo - Cylinder Block Coolant Drain	1
TC23	FITTING PT1/4-AN4	Water In / Cylinder Block Coolant Drain	1
TC24	FITTING 4AN M TO F 90°		1
TC25	BANJO FITTING M14 4AN 38.5mm	Water In / Turbocharger	1
TC26	COPPER WASHER M14×D21×D14×T1.0		2
TC27	WATER BOLT M14×P1.5×27mm		1
TC44	HOSE BAND 18-32mm	EGR Blind	1
TC43	BLIND PLUG	EGR Blind	1
TC45	HEAT RESISTANT HOISING	For TC28 OIL IN and TC14 WATER OUT HOSES	1
TC46	OIL PROOF HOSE	For TC35 and TC38 OIL DRAIN PIPES	1

EXHAUST MANIFOLD KIT

REF.	PART	LOCATION	QTY.
EM1	EXHAUST MANIFOLD		1
EM2	EXHAUST MANIFOLD GASKET		4
EM3	TURBINE IN GASKET		1
EM4	FLANGE NUT		2
EM5	HEX NUT		6
EM6	LOCK PLATE		2
EM7	STUD BOLT M8 13-20 38mm		4
EM8	FLANGE BOLT M6		1

INTERCOOLER PIPING KIT

REF.	PART	LOCATION	QTY.
IP1	INTAKE PIPE A Φ 70	Throttle Side	1
IP2	FITTING #8 STRAIGHT 1/8PT		1
IP3	HOSE BAND 18-32mm		2
IP4	INTAKE PIPE B Φ 50	Intercooler Side	1
IP5	SILICONE HOSE Φ 50 \times L=70 STRAIGHT		1
IP6	HOSE BAND 46-70mm		4
IP7	SILICONE HOSE Φ 50 ELBOW		1
IP8	SILICONE HOSE Φ 28- Φ 22	Intake/Suction Kit Side	1
IP9	HOSE BAND 18-32mm		1
IP10	HOSE BAND 21-44mm		1
IP11	OIL PROOF HOSE	Throttle Side / Blow-by hose	1

REQUIRED PARTS The following parts are required for installation.



PART No.	PART
TB601A-NS16A	EXHAUST MANIFOLD KIT EXPREME KA24DE S13/S14 TURBO TYPE

※ Please note that exhaust manifold kits from other makers might not include the manifold gasket.



PART No.	PART
12020480	INTERCOOLER KIT/SPEC-LS S14/S15 TYPE24E
11920202	SUCTION KIT Φ 80

※ This kit is designed to be used in conjunction with the above intercooler.

4. INSTALLING THE TURBOCHARGER KIT, TURBO EXHAUST MANIFOLD AND TURBO OUTLET/ELBOW.

4.1. PARTS & COMPONENTS

4.1.1. TURBOCHARGER KIT This kit is comprised of the below items.

 The HARDWARE PACK (TB403A-NS16PK) does *not* include the TC1 TURBOCHARGER.

Bolts, nuts and gaskets for the pipes and inlet/outlet elbows.

TC1			
	PART	TURBOCHARGER	
	QTY.	1	
	PART No.	-	
	COMPONENT(S)		PART No.
	CHAR	BX7960	TB403B-CRA01
		BX8270	TB403B-CRA08
	ACTUATOR	BX7960	TB401B-ACT09
		BX8270	
	COMPRESSOR HOUSING	BX7960	TB401B-COH04
BX8270		TB401B-COH05	
TURBINE HOUSING	BX7960	TB401B-TBH05	
	BX8270	TB401B-TBH06	

TC2		
	PART	COMPRESSOR IN PIPE
	QTY.	1
	PART No.	TB401B-CIP04

TC3		
	PART	FLANGE BOLT M6
	QTY.	3
	PART No.	TB401B-FBT01

TC4		
	PART	COMPRESSOR OUT PIPE
	QTY.	1
	PART No.	TB401B-COP04

TC5		
	PART	COMPRESSOR IN ADAPTER
	QTY.	1
	PART No.	TB401B-SPC04

Bolts, nuts and gaskets for the pipes and inlet/outlet elbows.

TC6		
	PART	STUD BOLT M8×P1.25 35mm
	QTY.	2
	PART No.	TB401B-STB04

TC7		
	PART	STUD BOLT M8×P1.25 38mm
	QTY.	2
	PART No.	TB401B-STB05

TC8		
	PART	HEX NUT M8×P=1.25mm
	QTY.	6
	PART No.	TB401B-HNT03

TC9		
	PART	FLANGE NUT M8×P=1.25mm
	QTY.	2
	PART No.	TB401B-FNT01

TC10		
	PART	TURBINE IN GASKET
	QTY.	1
	PART No.	TB401B-TIG03

TC11		
	PART	TURBINE OUT GASKET
	QTY.	1
	PART No.	TB401B-TOG03

TC12		
	PART	COMPRESSOR IN GASKET
	QTY.	2
	PART No.	TB401B-CIG01

TC13		
	PART	COMPRESSOR OUT GASKET
	QTY.	1
	PART No.	TB401B-COG02

**HOSES AND RELATED HARDWARE 1
WATER OUT**

TC14		
	PART	MESH HOSE 1350mm
	QTY.	1
	PART No.	TB401B-OPF13

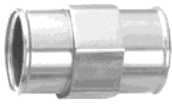
TC15		
	PART	WATER PIPE ADAPTER
	QTY.	1
	PART No.	TB401B-ADP03

TC16		
	PART	FITTING PT1/8 - 4AN
	QTY.	1
	PART No.	TB401B-FIT26

TC17		
	PART	FITTING 4AN M to F 90°
	QTY.	1
	PART No.	TB401B-FIT01

TC18		
	PART	HOSE BAND 27 - 51mm
	QTY.	2
	PART No.	TB401B-HBD03

TC19		
	PART	BANJO FITTING M14 4AN 38.5mm
	QTY.	1
	PART No.	TB401B-FIT21

TC20		
	PART	COPPER WASHER M14 D21 x D14 x T1.0
	QTY.	2
	PART No.	TB401B-WAS02

TC21		
	PART	WATER BOLT M14 x P1.5 27mm
	QTY.	1
	PART No.	TB401B-WTB01

**HOSES AND RELATED HARDWARE 2
WATER IN**

TC22		
	PART	MESH HOSE 200mm
	QTY.	1
	PART No.	TB401B-OFPO4

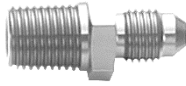
TC23		
	PART	FITTING PT1/4 - 4AN
	QTY.	1
	PART No.	TB401B-FIT25

TC24		
	PART	FITTING 4AN M to F 90°
	QTY.	1
	PART No.	TB401B-FIT01

TC25		
	PART	BANJO FITTING M14 4AN 38.5mm
	QTY.	1
	PART No.	TB401B-FIT21

TC26		
	PART	WASHER M14 D21 × D14 × T1.0
	QTY.	2
	PART No.	TB401B-WAS02

TC27		
	PART	WATER BOLT M14 × P1.5 27mm
	QTY.	1
	PART No.	TB401B-WTB01

**HOSES AND RELATED HARDWARE 3
OIL IN**

TC28		
	PART	MESH HOSE 940mm
	QTY.	1
	PART No.	TB401B-OPF14

TC29		
	PART	3WAY ADAPTER
	QTY.	1
	PART No.	TB401B-ADP02

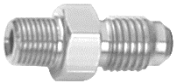
TC30		
	PART	FITTING PT1/8 - 4AN
	QTY.	1
	PART No.	TB401B-FIT26

TC31		
	PART	FITTING 4AN M to F 90°
	QTY.	2
	PART No.	TB401B-FIT01

TC32		
	PART	BANJO FITTING M12 4AN 50mm
	QTY.	1
	PART No.	TB401B-FIT04

TC33		
	PART	COPPER WASHER M12 x D18 x D12.2 x T1.2
	QTY.	2
	PART No.	TB401B-WAS04

TC34		
	PART	BANJO BOLT M12 x P1.25 H25.3 1.0
	QTY.	1
	PART No.	TB401B-BJB07

**HOSES AND RELATED HARDWARE 4
OIL OUT**

TC35		
	PART	OIL DRAIN PIPE A
	QTY.	1
	PART No.	TB401B-ODP06

TC36		
	PART	BOLT M6 × P1.0 16mm
	QTY.	2
	PART No.	TB401B-WBT01

TC37		
	PART	OIL RETURN GASKET
	QTY.	1
	PART No.	TB401B-ORG01

TC38 TC41																					
	PART	OIL DRAIN FITTING KIT																			
	QTY.	1																			
	PART No.	TB401B-ODK02																			
	<table border="1"> <thead> <tr> <th colspan="3">COMPONENT(S)</th> </tr> <tr> <th></th> <th>PART</th> <th>QTY.</th> </tr> </thead> <tbody> <tr> <td>TC38</td> <td>OIL DRAIN PIPE B</td> <td>1</td> </tr> <tr> <td>TC39</td> <td>HEX NUT M16</td> <td>1</td> </tr> <tr> <td>TC40</td> <td>WASHER M16</td> <td>1</td> </tr> <tr> <td>TC41</td> <td>SEAL WASHER M16</td> <td>1</td> </tr> </tbody> </table>			COMPONENT(S)				PART	QTY.	TC38	OIL DRAIN PIPE B	1	TC39	HEX NUT M16	1	TC40	WASHER M16	1	TC41	SEAL WASHER M16	1
	COMPONENT(S)																				
	PART	QTY.																			
TC38	OIL DRAIN PIPE B	1																			
TC39	HEX NUT M16	1																			
TC40	WASHER M16	1																			
TC41	SEAL WASHER M16	1																			

TC42		
	PART	HOSE BAND 18 - 32mm
	QTY.	2
	PART No.	TB401B-HBD04

OTHER

TC43		
	PART	BLIND CAP
	QTY.	1
	PART No.	TB401B-CAP02

TC44		
	PART	HOSE BAND 18 - 32mm
	QTY.	1
	PART No.	TB401B-HBD04

TC45		
	PART	HEAT RESISTANT HOISING 400mm
	QTY.	1
	PART No.	TB401B-TIT01

TC46		
	PART	OIL PROOF HOSE
	QTY.	1
	PART No.	TB401B-OPH01

TC47		
	PART	VACUUM HOSE 5X11mm
	QTY.	1
	PART No.	TB401B-SLH03

TC48		
	PART	ACTUATOR SPRING BLACK
	QTY.	1
	PART No.	TB401B-SPR07

TC49		
	PART	ACTUATOR SPRING RED
	QTY.	1
	PART No.	TB401B-SPR10

TC50		
	PART	ACTUATOR SPRING PINK
	QTY.	1
	PART No.	TB401B-SPR11

TC51		
	PART	ACTUATOR SPRING BLUE
	QTY.	1
	PART No.	TB401B-SPR11

TC52		
	PART	ACTUATOR NIPPLE (STRAIGHT)
	QTY.	1
	PART No.	TB401B-SAN01

OTHER

TC53		
	PART	BOLT SMOOTH PASTE
	QTY.	1
	PART No.	PB6150-BSP01

4.1.2. TURBO EXHAUST MANIFOLD KIT This kit is comprised of the below items.

EM1		
	PART	EXHAUST MANIFOLD
	QTY.	1
	PART No.	TB601A-NS16A01

EM2		
	PART	EXHAUST MANIFOLD GASKET
	QTY.	4
	PART No.	PB6150-FGK29

EM3		
	PART	TURBINE IN GASKET
	QTY.	1
	PART No.	PB6150-FGK10

EM4		
	PART	FLANGE NUT
	QTY.	2
	PART No.	PB6150-FNT10

EM5		
	PART	HEX NUT
	QTY.	6
	PART No.	PB6150-HNT07

EM6		
	PART	LOCK PLATE
	QTY.	2
	PART No.	PB6150-LPT02

EM7		
	PART	STUD BOLT M8
	QTY.	4
	PART No.	PB6150-SBT04

EM8		
	PART	FLANGE BOLT M6
	QTY.	1
	PART No.	PB6150-FBT12

EM9		
	PART	BOLT SMOOTH PASTE
	QTY.	1
	PART No.	PB6150-BSP01

4.2. MODIFICATIONS

4.2.1. ENGINE MOUNT BRACKET (LH)

Modify the LH engine mount bracket as shown below.

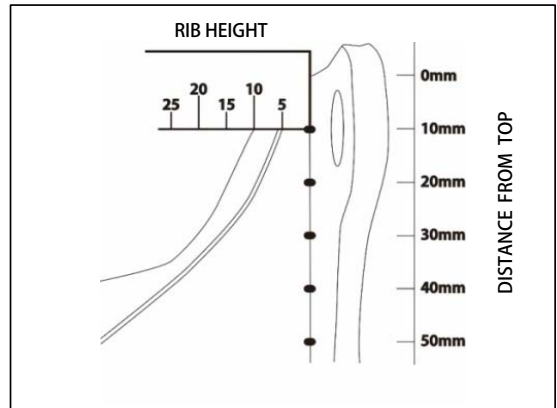
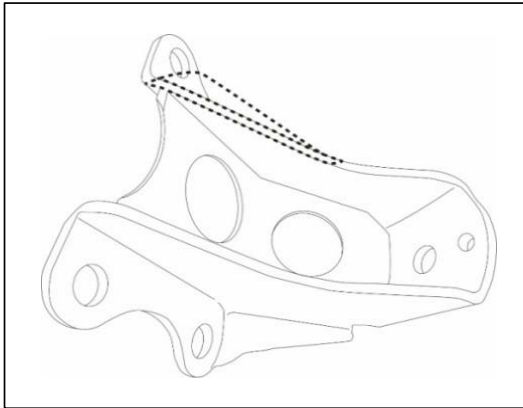

DISTANCE FROM TOP	RIB HEIGHT
10mm	5mm
20mm	10mm
30mm	15mm
40mm	25mm
50mm	35mm



WARNING

Ensure you wear appropriate safety goggles, gloves and dust mask.



CAUTION

Once the modification is complete, apply some paint to prevent rust.

4.2.2. OIL PAN

1. Clean the oil pan thoroughly and remove all gasket residue using a scraper.
2. Use a drill press or handheld drill to make a 16.5mm diameter hole in the oil pan as shown below.



Start with a smaller drill size first (10mm), then expand the hole to 16.5mm.

※ This helps to ensure that the final hole is positioned/centered correctly.



Vertically, the hole center should be 18mm from the oil pan flange.



Horizontally, the hole center should be 33mm from the bolt hole center pictured left.

4.3. PREPARING & REINSTALLING THE OIL PAN

1. Clean the modified oil pan thoroughly.
2. Attach the OIL DRAIN PIPE B to the oil pan as shown below.



The OIL DRAIN PIPE B should be installed parallel to the oil pan flange.



REF.	PART	QTY.
TC38	OIL DRAIN PIPE B	1
TC39	HEX NUT M16	1
TC40	WASHER M16	1
TC41	SEAL WASHER M16	1

TORQUE SPEC.	
<1>	T=89.2N · m (9.1kgf · m)

CAUTION

After installing the above hardware, ensure you test for leaks using water.
Once the checks are complete, allow the oil pan to dry completely.

3. Apply liquid (silicon) gasket to the oil pan flange.

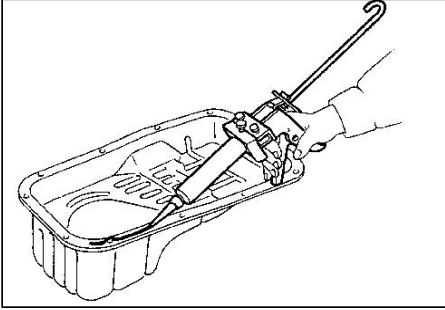

4. Carefully pass the oil pan together with the oil strainer over the front cross member making sure that the liquid (silicon) gasket doesn't come into contact with the surrounding components.

5. Attach the oil strainer to the cylinder block.

6. Attach the oil pan to the cylinder block.

TORQUE SPEC.	T=9.0N · m (0.9kgf · m)
--------------	-------------------------

4.4. REINSTALLING THE STOCK COMPONENTS

Reinstall the front stabilizer, crossmember, AC belt, gussets, modified LH engine mount bracket, radiator and radiator fan shroud.



4.5. INSTALLING THE TURBO EXHAUST MANIFOLD AND TURBO OUTLET/ELBOW

4.5.1. PREPARING THE TURBOCHARGER

Attach the included stud bolts to the turbocharger.

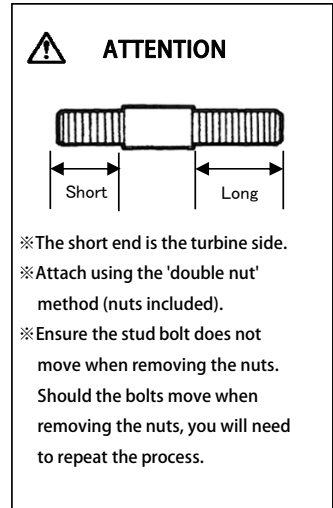
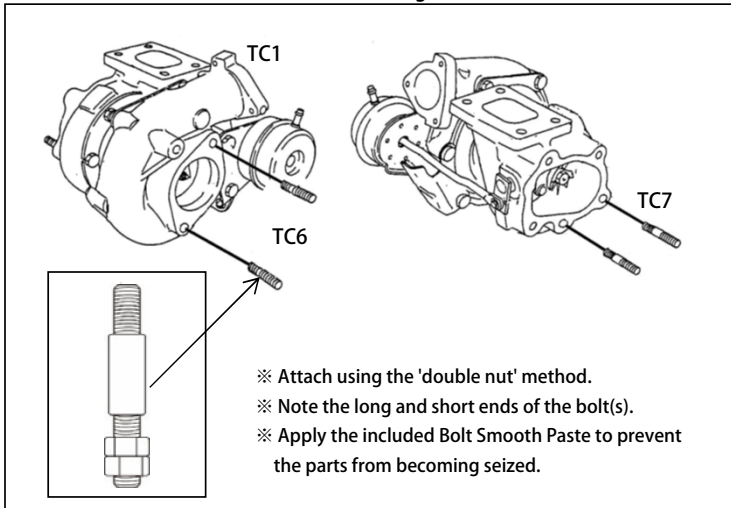

REF.	PART	QTY.
TC1	TURBOCHARGER	1
TC6	STUD BOLT M8*P1.25 35mm	2
TC7	STUD BOLT M8*P1.25 38mm	2

TORQUE SPEC.	T=19.6~21.6N · m (2.0~2.2kgf · m)
--------------	-----------------------------------

4.5.2. PREPARING THE EXHAUST MANIFOLD

Attach the included stud bolts to the exhaust manifold

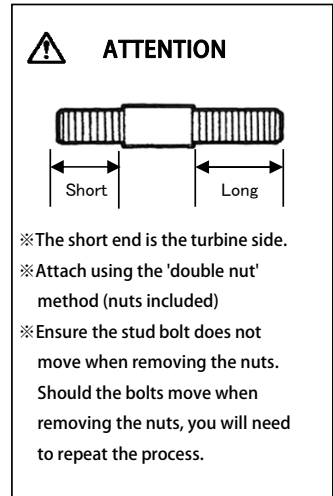
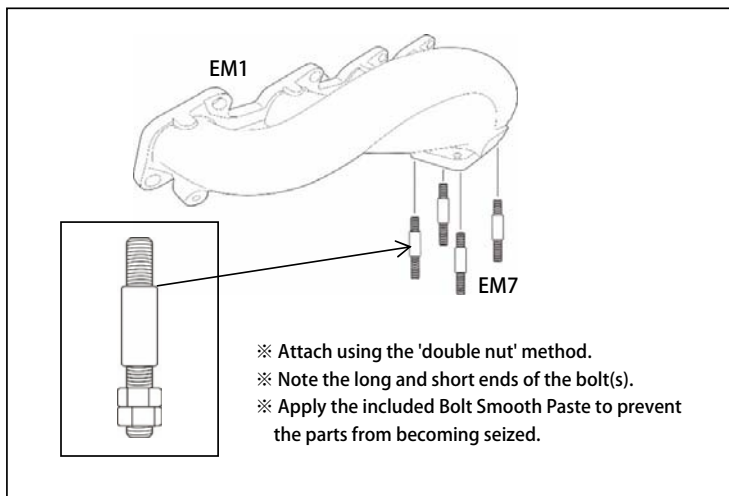

REF.	PART	QTY.
EM1	EXHAUST MANIFOLD	1
EM7	STUD BOLT M8	4

TORQUE SPEC.	T=19.6~21.6N · m (2.0~2.2kgf · m)
--------------	-----------------------------------

4.5.3. ASSEMBLING THE TURBOCHARGER, TURBO EXHAUST MANIFOLD AND TURBO OUTLET/ELBOW

※Refer to the manual included with your preferred choice of TURBO OUTLET/ELBOW for details.

TOMEI TURBO OUTLET/ELBOW RECOMMENDED

PART No.	PART
TB6020-NS08C	TURBINE OUTLET PIPE KIT EXPREME SR20DET

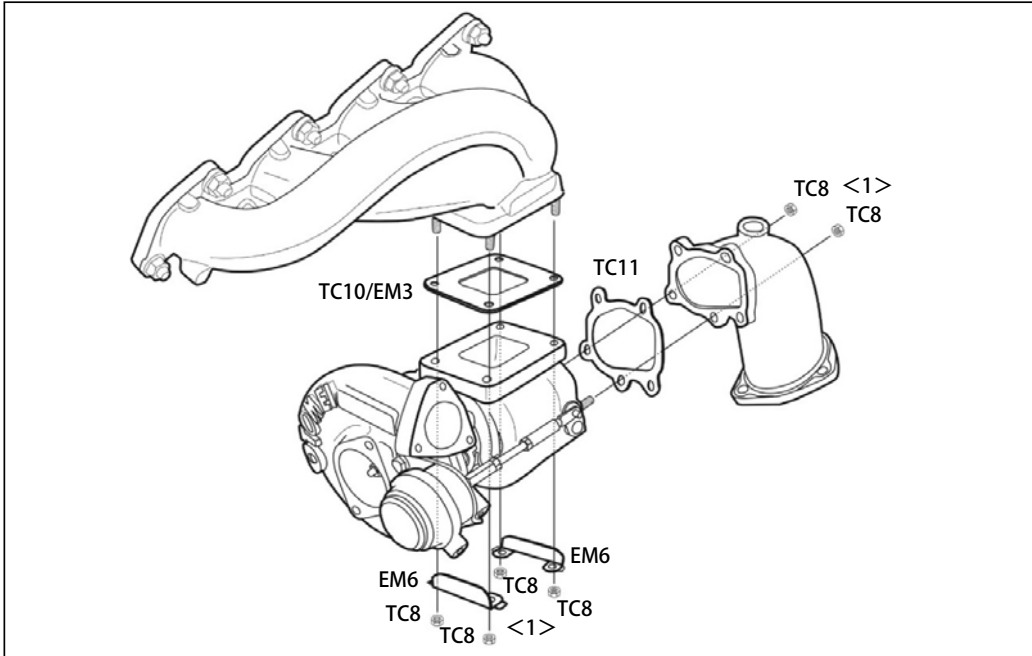

REF.	PART	QTY.
TC8	HEX NUT M8×P=1.25	6
TC10 / EM3	TURBINE IN GASKET	1
TC11	TURBINE OUT GASKET	1
EM6	LOCK PLATE	2

TORQUE SPEC.	
<1>	T=21.0N · m(2.1kgf · m)

CAUTION

※Ensure orientation is correct.

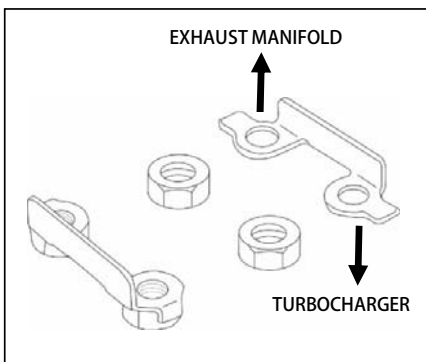

※ After tightening down the lock plates, bend the tabs to secure into position.

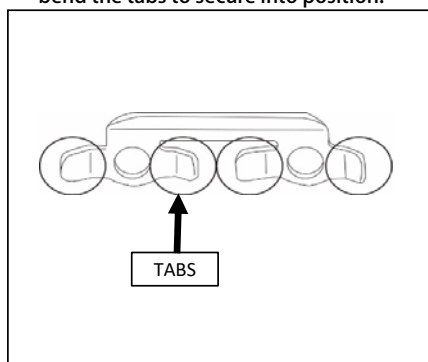

※Apply the included Bolt Smooth Paste to prevent the parts from becoming seized.

4.6. ATTACHING THE TURBOCHARGER HOSES, TUBES AND PIPES

CAUTION

Ensure each part is positioned and orientated as shown below. Failing to do so will not only result in damage to the turbo from insufficient lubrication/cooling, but will also prevent the TURBO ASSY from being installed.

4.6.1. WATER OUT HOSE

1. Attach the MESH HOSE to the BANJO FITTING.

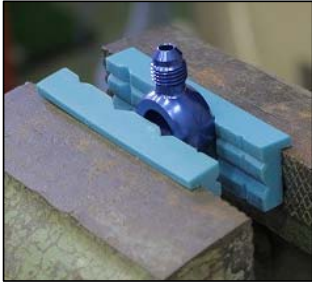

2. Using the included WATER BOLT and WASHERs, attach the BANJO FITTING and MESH HOSE to the turbocharger.

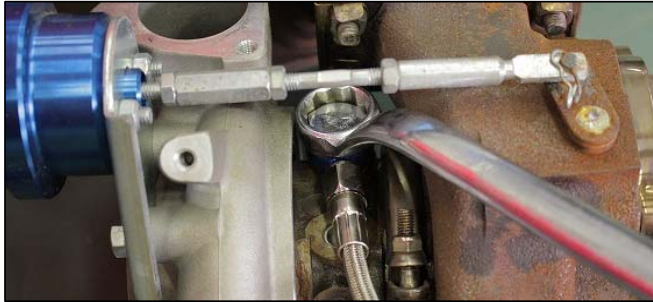

REF.	PART	QTY.
TC14	MESH HOSE 1350mm	1
TC19	BANJO FITTING M14 4AN 38.5mm	1
TC20	WASHER M14 D21 × D14 × T1.0	2
TC21	WATER BOLT M14 × P1.5 27mm	1

TORQUE SPEC.	
<1>	T=31.4N · m(3.2kgf · m)

4.6.2. WATER IN HOSE

1. Attach the MESH HOSE to the BANJO FITTING.

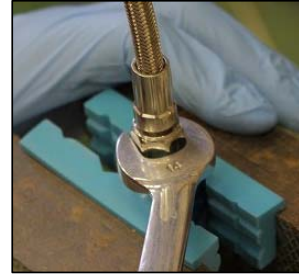

2. Using the included WATER BOLT and WASHERs, attach the BANJO FITTING and MESH HOSE to the turbocharger.



REF.	PART	QTY.
TC22	MESH HOSE 200mm	1
TC25	BANJO FITTING M14 4AN 38.5mm	1
TC26	WASHER M14 D21 × D14 × T1.0	2
TC27	WATER BOLT M14 × P1.5 27mm	1

TORQUE SPEC.	
<1>	T=31.4N · m(3.2kgm)

4.6.3. OIL IN HOSE

1. Attach the FITTING 4AN M to F 90° adapter to the BANJO FITTING.
 2. Using the included BANJO BOLT and WASHERs, attach the above on to the turbocharger.
 3. Attach the MESH HOSE to the FITTING 4AN M to F 90° adapter.
- ※ Ensure that the FITTING 4AN M to F 90° adapter is orientated as shown below (see ①).

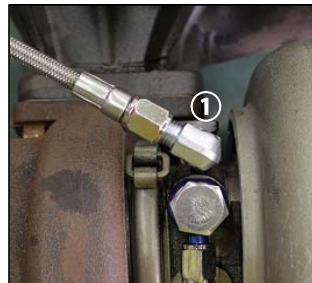

REF.	PART	QTY.
TC28	MESH HOSE 940mm	1
TC32	BANJO FITTING M12 4AN 50mm	1
TC34	BANJO BOLT M12×P1.25 H25.3 1.0	1
TC33	COPPER WASHER M12×D18×D12.2×T1.2	2
TC31	FITTING 4AN M to F 90°	1

TORQUE SPEC.	
<1>	T=31.4N • m(3.2kgm)

4.6.4. OIL DRAIN PIPE

Attach the OIL DRAIN PIPE A as shown below.

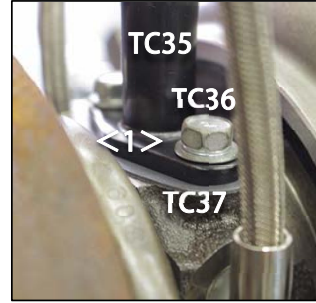
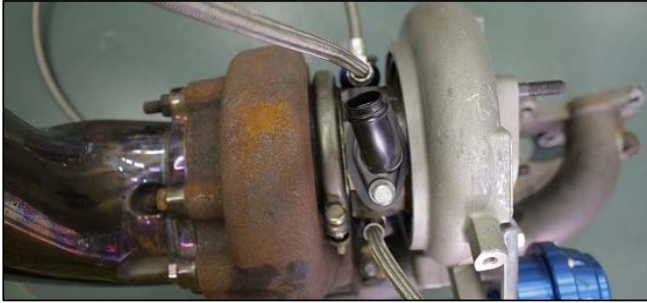

REF.	PART	QTY.
TC35	OIL DRAIN PIPE A	1
TC36	BOLT M6*P1.0 16mm	2
TC37	OIL RETURN GASKET	1

TORQUE SPEC.	
<1>	T=9N · m(0.9kgm)

4.6.5. HEAT RESISTANT HOISING

Cover the WATER OUT HOSE (from step 4.6.1.) and the OIL IN HOSE (from step 4.6.3.) using the included HEAT RESISTANT HOISING.

CAUTION

Cut the HEAT RESISTANT HOISING to length and use it to prevent heat damage from the turbo.

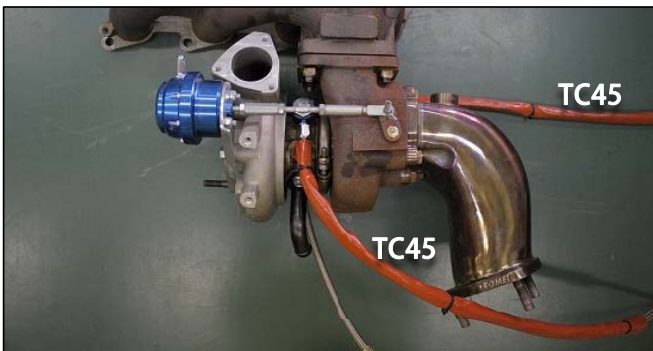

※ Use zip ties where necessary to secure the hosing in place.

REF.	PART	QTY.
TC45	HEAT RESISTANT HOISING	1

4.6.6. WATER IN FITTING ADAPTER (to cylinder block)

Attach the FITTING 4AN M to F 90° adapter to the WATER IN HOSE (from step 4.6.2.) as shown below.



REF.	PART	QTY.
TC24	FITTING 4AN M to F 90°	1

4.6.7. COMPRESSOR INLET ELBOW PIPE

Install the COMPRESSOR IN PIPE onto the turbocharger compressor housing.



REF.	PART	QTY.
TC2	COMPRESSOR IN PIPE	1
TC5	COMPRESSOR IN ADAPTER	1
TC12	COMPRESSOR IN GASKET	2
TC9	FLANGE NUT M8*P=1.25mm	2

TORQUE SPEC.	
<1>	T=31.4N · m(3.2kgm)

CAUTION

Do *not* modify the COMPRESSOR IN ADAPTER. It is specifically designed to prevent over boosting.

4.6.8. COMPRESSOR OUTLET ELBOW PIPE

Install the COMPRESSOR OUT PIPE onto the turbocharger compressor housing.

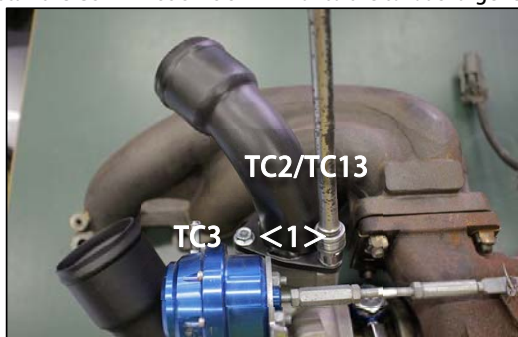

REF.	PART	QTY.
TC4	COMPRESSOR OUT PIPE	1
TC3	FLANGE BOLT M6	3
TC13	COMPRESSOR OUT GASKET	1

TORQUE SPEC.	
<1>	T=9N · m(0.9kgm)

CAUTION

This product (TURBOCHARGER KIT and/or HARDWARE PACK) is designed to be used in conjunction with the below product(s) from GREDDY.

Additional piping and/or modifications may be required when using alternative/other products.

Greddy

PART No.	DESCRIPTION
12020480	INTERCOOLER KIT/SPEC-LS S14/S15 TYPE24E
11920202	SUCTION KIT Φ80

4.7. INSTALLING THE COMPONENTS ONTO THE ENGINE

CAUTION

Using excessive force to tighten the banjo/adaptor fittings can damage the parts and/or the engine. In some instances, you may need to remove the engine from the vehicle to repair the damage caused by this.

4.7.1. OIL PRESSURE SENSOR

1. Apply thread sealing tape to the included PT 1/8 4AN and 3 WAY adapter fittings



2. Install the 3 WAY ADAPTER as shown below.



3. Combine the PT 1/8 4AN and 90° fitting adapters and install onto the 3 WAY ADAPTER as shown below.



4. Install the oil pressure sensor onto the 3 WAY ADAPTER and reconnect the sensor coupler.
The oil filter should also be reinstalled.



REF.	PART	QTY.
TC29	3WAY ADAPTER	1
TC30	FITTING PT1/8 - 4AN	1
TC31	FITTING 4AN M to F 90°	1

4.7.2. WATER IN FROM CYLINDER BLOCK

Apply thread sealing tape to the FITTING PT1/4 - 4AN adapter and install onto the cylinder block.



REF.	PART	QTY.
TC23	FITTING PT1/4 - 4AN	1

4.7.3. WATER OUT TO UPPER RADIATOR HOSE

1. Temporarily reattach the upper radiator hose.
2. Starting at 35mm from the bend, carefully cut out a 20mm section of the upper radiator hose as shown below.

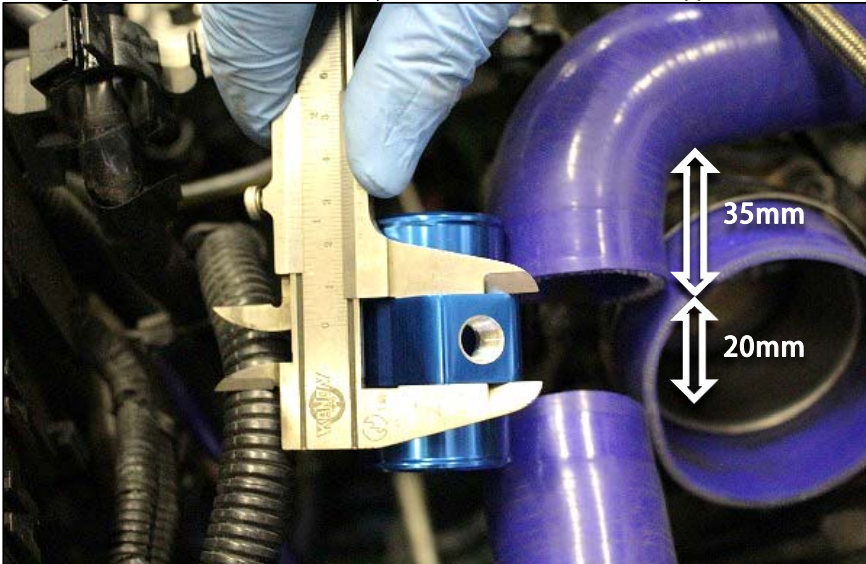

3. Install the WATER PIPE ADAPTER using the included HOSE BANDS.

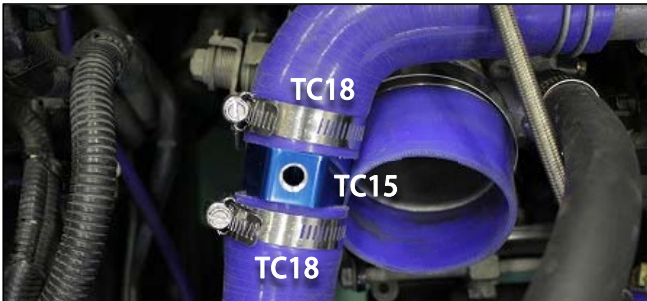

4. Apply thread sealing tape to the FITTING PT1/8 - 4AN adapter. Then, combine with the FITTING 4AN M to F 90° adapter and install onto the WATER PIPE ADAPTER.



REF.	PART	QTY.
TC15	WATER PIPE ADAPTER	1
TC16	FITTING PT1/8 - 4AN	1
TC17	FITTING 4AN M to F 90°	1
TC18	HOSE BAND 27 - 51mm	2

4.7.4. TURBOCHARGER ASSY

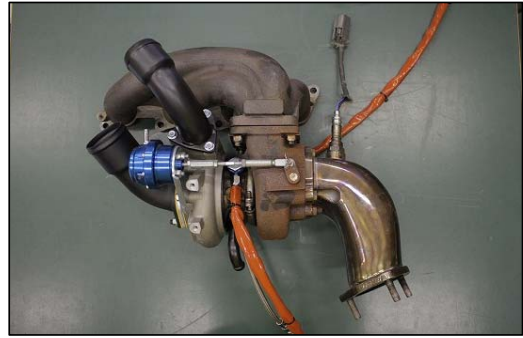

1. Test fit the TURBOCHARGER ASSY onto the engine together with the included EXHAUST MANIFOLD GASKETS. Use the stock nuts to temporarily secure in place.
2. Check there is sufficient clearance between the modified LH engine mount bracket and the turbocharger unit.
 ※ Should there be insufficient clearance, modify the LH engine mount bracket accordingly.
3. Once sufficient clearance have been confirmed/achieved, tighten down the LH engine mount bracket.
4. Replace the stock nuts used in step 1. with those included in the kit and secure the EXHAUST MANIFOLD in place.

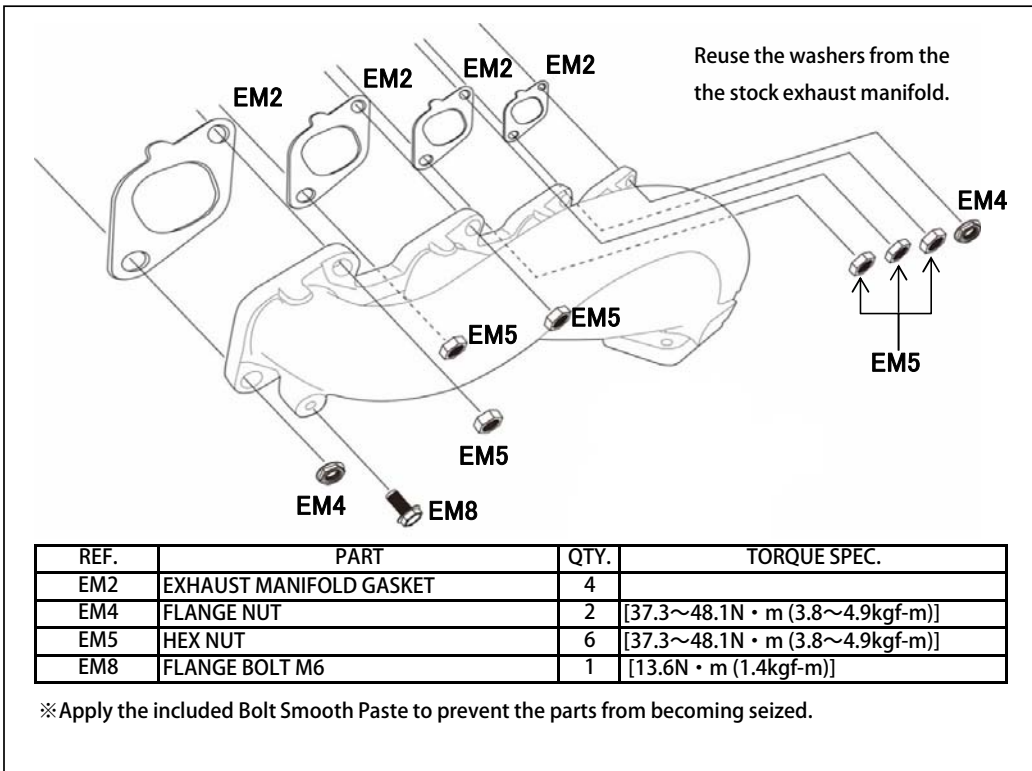

4. Secure the oil dip stick to the exhaust manifold using the included FLANGE BOLT.



CAUTION

- Ensure sufficient clearance and correct fitment has been achieved before completely tightening down the fastenings. In some cases, there may be insufficient clearance due to minor differences between individual vehicles. In such a case, loosen the fastenings on each component and adjust the positioning until sufficient clearance is achieved before retightening the fastenings again.
- Ensure you clean the EXHAUST MANIFOLD after installation. Using the EXHAUST MANIFOLD with oil or other debris on it can cause blemishes and/or burn marks.
- Depending on the setup and/or use, heat from the Exhaust manifold can damage the surrounding components. Thermal insulation should be used where necessary to prevent this.

4.7.5. HOSES

4.7.5.1. WATER IN HOSE

Connect the WATER IN HOSE (from step 4.6.2.) to the WATER IN fitting adapter (from step 4.7.2.)



4.7.5.2. OIL IN HOSE

1. Carefully route the OIL IN HOSE (from step 4.6.3.) over the bell housing, between the engine and firewall.

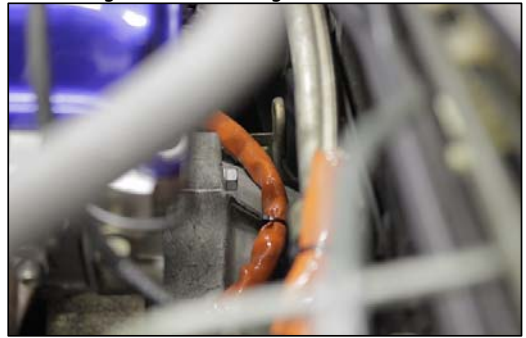

2. From there, route the hose alongside the stock wiring/harness and connect to the 3 WAY ADAPTER (from step 4.7.1.) Use zip ties where necessary to anchor the hose in place as circled below.

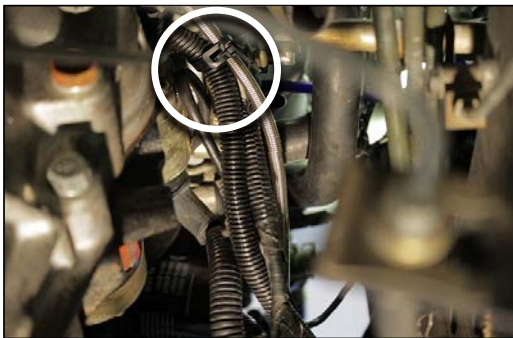

4.7.5.3. WATER OUT HOSE

1. Carefully route the WATER OUT HOSE (from step 4.6.1.) between the engine and firewall.

 Ensure that the hose does *not* make contact with the turbocharger/exhaust components.



2. From there, route the hose under the intake manifold and (loosely) anchor in place where necessary.

※ Depending on your setup, you may need to route the hose around the intake manifold instead.

3. Connect the hose to the WATER PIPE ADAPTER (from step 4.7.3.).



4.7.5.4. OIL DRAIN

1. Attach the OIL PROOF HOSE to OIL DRAIN PIPE A (from step 4.6.4.) using the included HOSE BAND.



2. Cut the OIL PROOF HOSE to the appropriate length and connect onto OIL DRAIN PIPE B (from step 4.3.) and secure using the included HOSE BAND.

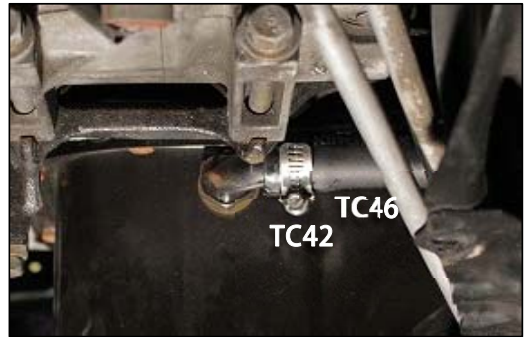

REF.	PART	QTY.
TC42	HOSE BAND 18 - 32mm	2
TC46	OIL PROOF HOSE	1

CAUTION

Ensure the hoses are routed tension-free and away from the TURBOCHARGER and/or EXHAUST MANIFOLD to avoid heat damage.

4.8. OTHER

4.8.1. REATTACHING THE STEERING SHAFT

Check that everything is fitted correctly and that sufficient clearance has been achieved. Then proceed to reconnect the steering shaft, making sure the U-Joint and steering rack pinion gear align correctly.

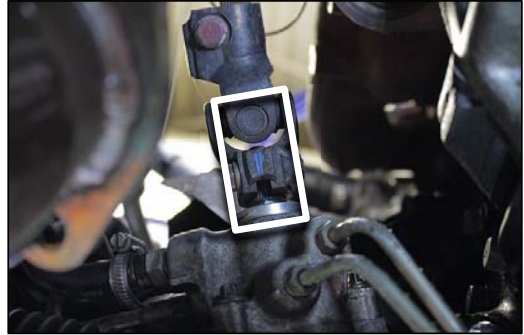
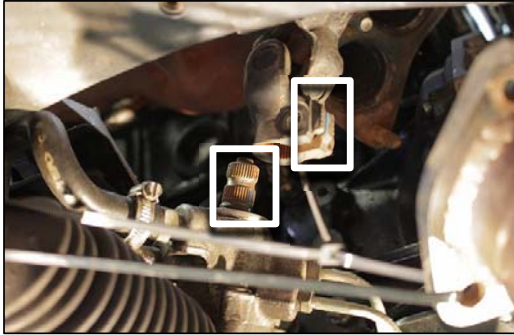

4.8.2. (RE)INSTALLING EXHAUST COMPONENTS

(Re)install the exhaust (front, center and rear sections).

※

4.8.3. EGR BLIND PLUG

Cover the EGR valve with the BLIND CAP and secure using the included HOSE BAND.



REF.	PART	QTY.
TC43	BLIND CAP	1
TC44	HOSE BAND 18 - 32mm	1

4.8.4. INSTALLING AN AIR INTAKE

Please refer to the installation manual included with you preferred choice of turbo intake.



CAUTION

This product (TURBOCHARGER KIT and/or HARDWARE PACK) is designed to be used in conjunction with the below product(s) from GREDDY. Additional piping and/or modifications may be required when using alternative/other products.

Greddy

PART No.	DESCRIPTION
12020480	INTERCOOLER KIT/SPEC-LS S14/S15 TYPE24E
11920202	SUCTION KIT Φ 80

5. INSTALLING THE INTERCOOLER PIPING KIT

5.1. PARTS AND COMPONENTS

IP1		
	PART	INTAKE PIPE A Φ 70
	QTY.	1
	PART No.	TB410B-ITP01

IP2		
	PART	FITTING #8 STRAIGHT 1/8PT
	QTY.	1
	PART No.	TB410B-FIT01

IP3		
	PART	HOSE BAND 18 -32mm
	QTY.	2
	PART No.	TB401B-HBD04

IP4		
	PART	INTAKE PIPE B Φ 50
	QTY.	1
	PART No.	TB410B-ITP02

IP5		
	PART	SILICONE HOSE Φ 50 \times L=70 STRAIGHT
	QTY.	1
	PART No.	TB410B-SLH01

IP6		
	PART	HOSE BAND 46 -70mm
	QTY.	4
	PART No.	TB410B-HBD01

IP7		
	PART	SILICONE HOSE Φ 50 ELBOW
	QTY.	1
	PART No.	TB410B-ELH01

IP8		
	PART	SILICONE HOSE Φ 28 - Φ 22
	QTY.	1
	PART No.	TB410B-RDH01

IP9		
	PART	HOSE BAND 18 -32mm
	QTY.	1
	PART No.	TB401B-HBD04

IP10		
	PART	HOSE BAND 21 -44mm
	QTY.	1
	PART No.	TB410B-HBD02

IP11		
	PART	OIL PROOF HOSE
	QTY.	1
	PART No.	TB401B-OPH01

REQUIRED PARTS The following parts are required for installation.



PART No.	DESCRIPTION	
TB403A-NS16C	TURBOCHARGER KIT ARMS BX7960 KA24DE	EITHER ONE
TB403A-NS16D	TURBOCHARGER KIT ARMS BX8270 KA24DE	
TB403A-NS16PK	TURBOCHARGER KIT ARMS KA24DE HARDWARE PACK	for installing other turbochargers
TB601A-NS16A	EXHAUST MANIFOLD KIT EXPREME KA24DE S13/S14 TURBO TYPE	

※ Please note that exhaust manifold kits from other makers might not include the manifold gasket.



PART No.	DESCRIPTION
12020480	INTERCOOLER KIT/SPEC-LS S14/S15 TYPE24E
11920202	SUCTION KIT Φ80



CAUTION

This product has been designed to work in conjunction with the above products.
Alternative products can also be installed but may require some modification and/or additional parts.

5.2. INSTALLING THE GREDDY INTERCOOLER KIT

Install the intercooler core together with the 2 connecting pipes as detailed in the GREDDY installation manual.

※ The GREDDY I-3 intercooler tube (see GREDDY installation manual) will not be used.

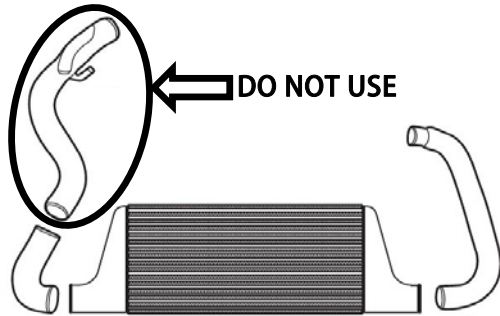

CAUTION

- Installing the GREDDY intercooler kit requires the stock battery to be replaced with a smaller unit. Alternatively, the stock battery may be relocated instead (e.g. to the trunk).

BATTERY SIZE	34B19L
DIMENSIONS	185×125×210mm or smaller

- Installation will require an opening to be cut into the battery tray.

※ See GREDDY installation manual for details.

5.3. INSTALLING THE INTERCOOLER PIPING KIT

5.3.1. INTAKE PIPE A

1. Apply thread sealing tape to the FITTING #8 STRAIGHT 1/8PT adapter and install onto INTAKE PIPE A. Ensure you also remove the rubber cap from the AACV (IACV) connecting tube.



2. Install INTAKE PIPE A onto the throttle body and pass the opposite end through the opening in the battery tray. Then, cut the included OIL PROOF HOSE to length and use the provided hose bands to connect the AACV (IACV) to INTAKE PIPE A.

The FITTING #8 STRAIGHT 1/8PT adapter can be used to connect devices such as a boost controller.

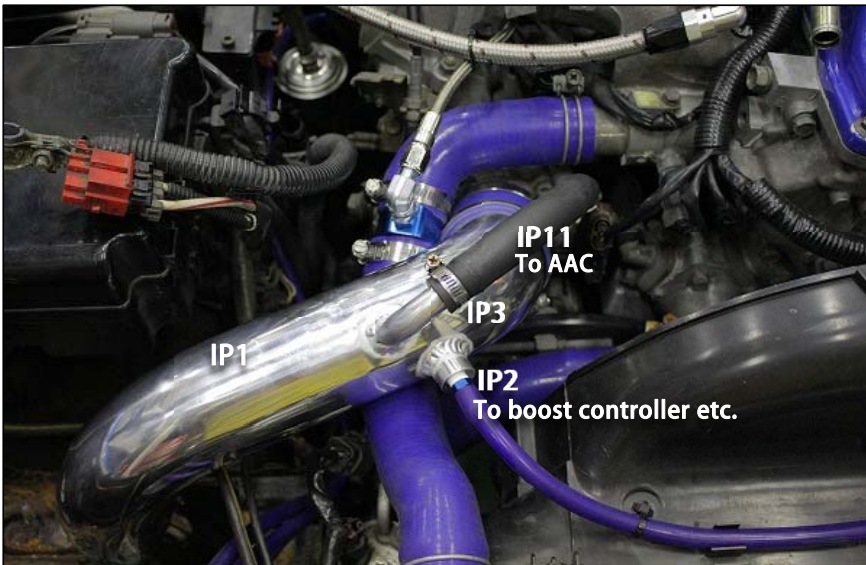

※ The silicone hose for connecting devices such as a boost controller will need to be purchased separately.

CAUTION

The OIL PROOF HOSE should be cut to length so that there are no kinks once the hose is installed.

REF.	PART	QTY.
IP1	INTAKE PIPE A Φ 70	1
IP2	FITTING #8 STRAIGHT 1/8PT	1
IP3	HOSE BAND 18 - 32mm	2
IP11	OIL PROOF HOSE	1

5.3.2. INTAKE PIPE B

1. Using the included HOSE BANDS, install the SILICONE $\Phi 50 \times L=70$ STRAIGHT HOSE onto the COMPRESSOR OUTLET PIPE and the SILICONE $\Phi 50$ ELBOW HOSE onto the GREDDY intercooler pipe as shown below. Then, install INTAKE PIPE B and secure in place with the provided HOSE BANDS.



REF.	PART	QTY.
IP4	INTAKE PIPE B $\Phi 50$	1
IP5	SILICONE HOSE $\Phi 50 \times L=70$ STRAIGHT	1
IP6	HOSE BAND 46 - 70mm	4
IP7	SILICONE HOSE $\Phi 50$ ELBOW	1



CAUTION

INTAKE PIPE B can be installed either way round.
Ensure there is also sufficient clearance with the hood, turbo air intake and other surrounding components.

5.3.3 BLOW-BY HOSE

1. Connect the blow-by hose from the cylinder head to the turbo air intake using the provided OIL PROOF HOSE and SILICONE HOSE $\Phi 28 - \Phi 22$ as shown below.

CAUTION

The OIL PROOF HOSE should be cut to length so that there are no kinks once the hose is installed.



	PART	QTY.
IP8	SILICONE HOSE $\Phi 28 - \Phi 22$	1
IP9	HOSE BAND 18 -32mm	1
IP10	HOSE BAND 21 -44mm	1
IP11	OIL PROOF HOSE	1
※	Reuse stock item	1

5.3.4. INTERCOOLER

Ensuring that sufficient clearance has been achieved, connect the bottom end of INTAKE PIPE A to the intercooler piping and tighten down all hose bands to complete the installation.



6. POST INSTALLATION

6.1. REFILL ENGINE OIL

6.2. (RE)CONNECT BATTERY



CAUTION

See GREDDY intercooler installation manual for details.

6.3. REFILL COOLANT AND 'BLEED' SYSTEM



CAUTION

- Ensure you use the appropriate coolant. Using only water can cause the aluminum components to corrode.
- Ensure you properly 'bleed' the cooling system. Air in the cooling system can lead to overheating.



WARNING

- To avoid scalding, do *not* open the radiator cap when coolant temperatures are high.

1. Check to make sure that the hose bands on the radiator and heater hoses are tightened down. Ensure that the drain bolt is also tightened down.
2. Set the heater temperature control lever to 'HOT'.
3. Remove the radiator cap and air relief plug.
4. Slowly fill the radiator with coolant until full to the brim. Once coolant begins to over flow from the air relief, reinstall the plug, then proceed to fill the radiator to the brim.
5. Close the radiator cap and start the engine. Maintain the idle until the thermostat opens.
6. Consult the water temperature gauge. Once the temperature has risen beyond the midpoint, check to see whether the thermostat has opened by feeling the lower radiator hose to check that warm coolant is flowing.
7. Once you have confirmed that the thermostat has opened, rev the engine to 2000-3000rpm and hold for around 10 seconds, making sure water temperatures stay within acceptable limits. Repeat this step several times.
8. Stop the engine.
9. After the engine has cooled, open the radiator cap and check the coolant level. If the level has dropped, repeat the above steps.
10. When the coolant level no longer drops, fill the coolant reservoir to 'MAX'.

7. CHECKS AND PRECAUTIONS

- ① Ensure the vehicle is in neutral gear and check that the parking brake is engaged.
- ② Crank the engine for around 15 seconds but ensure you do *not* start the engine.
- ③ Start the engine and check for any signs of oil or coolant leaks during idle.
- ④ Stop the engine. Check to make sure that the oil and coolant are at acceptable levels. Be sure to also check the coolant reservoir level.
- ⑤ Start the engine again and rev to 3000rpm. Thoroughly check for any exhaust leaks and/or abnormal sounds.
- ⑥ Test drive the vehicle and check to make sure that the turbo is generating pressure/boost.



- By default, the actuator (standalone) is configured to give 1.0kg spring pressure with 2mm of preload applied.
- The actual boost pressure will vary depending on pre-turbo back pressure as well as the surrounding components installed. A boost controller should be used in conjunction to make precise adjustments to boost pressure.
- For details on changing actuator springs, please refer to the included actuator manual.
- Ensure you monitor boost levels using a boost gauge.

- ⑦ Check to ensure all parts are fitted correctly and that there are no oil/coolant leaks.



- Do *not* turn the engine off immediately after hard driving.
- Ensure you periodically change the engine oil.



WARNING

- Ensure checks are conducted thoroughly as incorrect fitment and/or loose parts can damage other components.
- Exhaust leaks are not only a health hazard but can also lead to reduced performance.
- Should you notice anything abnormal whilst driving, stop the vehicle immediately and check for faults.
- Make sure all parts have completely cooled before commencing any repair work.
- Should you notice any missing and/or broken parts, do *not* attempt to restart the engine. Instead, consult a trained professional and follow their instructions.



CAUTION

- The ECU as well as other parts of the vehicle will need to be adjusted/upgraded accordingly.
- Engine parts, fluids and any other related components should be selected carefully.

8. SETUP AND SETTINGS

8.1. TURBOCHARGER SPECIFICATIONS

BX7960

COMPRESSOR WHEEL					
INLET DIA. (mm)	OUTER DIA. (mm)	TRIM	BLADES	MATERIAL	CONSTRUCTION
52.6	68.0	60	6	A2618	CNC BILLET

TURBINE WHEEL					
EXIT DIA. (mm)	OUTER DIA. (mm)	TRIM	BLADES	MATERIAL	CONSTRUCTION
54.0	61.0	79	9	K418	CAST

COMPRESSOR HOUSING			TURBINE HOUSING		
INLET DIA. (mm)	EXIT DIA. (mm)	A/R	INLET	EXIT	A/R
53.5	38.5	0.62	T25	SR20DET	0.57

BX8270

COMPRESSOR WHEEL					
INLET DIA. (mm)	OUTER DIA. (mm)	TRIM	BLADES	MATERIAL	CONSTRUCTION
59.0	76.2	60	6	A2618	CNC BILLET

TURBINE WHEEL					
EXIT DIA. (mm)	OUTER DIA. (mm)	TRIM	BLADES	MATERIAL	CONSTRUCTION
58.8	67.0	77	9	K418	CAST

COMPRESSOR HOUSING			TURBINE HOUSING		
INLET DIA. (mm)	EXIT DIA. (mm)	A/R	INLET	EXIT	A/R
60.0	38.8	0.62	T25	SR20DET	0.57

8.2. ACTUATOR SPRINGS

This product features interchangeable actuator springs, allowing you to set different boost pressures. Use the following information as reference to choose the appropriate spring(s) for your setup.



CHOOSING ACTUATOR SPRINGS

The table on the next page shows the standalone pressure/spring rate of each spring. All pressure/spring rates were measured just as the internal wastegate begins to open. Always ensure you measure and choose the appropriate spring(s) for your particular setup. For details on how to change actuator springs, please refer to the separate actuator manual.

- ※ The table on the next page shows the standalone pressure/spring rate of each spring with 2mm of preload applied.
- ※ The included actuator ships preconfigured with 1.0kgf/cm² springs as shown in the table on the next page.
- ※ The table on the next page should be used for reference only as actual boost pressure will vary depending on the setup.
- ※ A boost controller should be used in conjunction to accurately adjust boost settings. For best results, the boost controller should be used as the main boost control device, with the actuator springs providing a secondary level of adjustment.

HOW TO CHOOSE ACTUATOR SPRINGS (EXAMPLE)

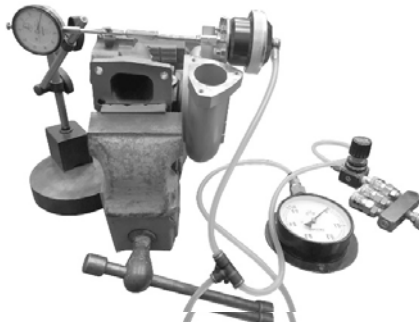

- Clamp/secure the actuator on a stable surface so that it doesn't move.
- Next, set up a dial indicator or similar tool so that you can accurately measure actuator rod travel.
- Using an air compressor and pressure gauge, apply air pressure to the actuator.
- Note the pressure at which the actuator rod begins to move.
- Then, use the following table to choose the appropriate spring(s) for your setup.

STANDALONE	kgf/cm ²	0.20	0.4	0.6	0.9	0.65	0.75
SPRING	Kpa	19.61	39.23	58.84	88.26	63.74	73.55
PRESSURE	PSI	2.84	5.69	8.53	12.80	9.25	10.67
POSITIONING		INNER	INNER	MIDDLE	MIDDLE	OUTER	OUTER
P/N		TB401B -SPR07	TB401B -SPR08	TB401B -SPR09	TB401B -SPR10	TB401B -SPR11	TB401B -SPR12
COLOR		BLACK	SILVER	PURPLE	RED	PINK	BLUE
SIZE	O.D (mm)	29	29	36.5	36.5	44	44
	LENGTH (mm)	32	36	43	52	57	68
CONFIGURED PRESSURE							
kgf/cm ²	Kpa	PSI					
0.20	19.61	2.84	0.20				
0.40	39.23	5.69		0.40			
0.60	58.84	8.53			0.60		
0.65	63.74	9.25				0.65	
0.75	73.55	10.67					0.75
0.80	78.45	11.38	0.20		0.60		
0.85	83.36	12.09	0.20			0.65	
0.90	88.26	12.80				0.90	
0.95	93.16	13.51	0.20				0.75
1.00	98.07	14.22		0.40	0.60		
1.05	102.97	14.93		0.40		0.65	
1.10	107.87	15.65	0.20			0.90	
1.15	112.78	16.36		0.40			0.75
1.25	122.58	17.78			0.60	0.65	
1.30	127.49	18.49		0.40		0.90	
1.35	132.39	19.20			0.60		0.75
1.45	142.20	20.62	0.20		0.60	0.65	
1.55	152.00	22.05	0.20		0.60		0.75
1.55	152.00	22.05				0.90	0.65
1.65	161.81	23.47		0.40	0.60		0.65
1.65	161.81	23.47				0.90	0.75
1.75	171.62	24.89	0.20			0.90	0.65
1.75	171.62	24.89		0.40	0.60		0.75
1.85	181.42	26.31	0.20			0.90	0.75
1.95	191.23	27.74		0.40		0.90	0.65
2.05	201.04	29.16		0.40		0.90	0.75

8.3. ADDITIONAL/RECOMMENDED PARTS

8.3.1. TOMEI PARTS



HEAD GASKET	
HEAD GASKET KA24DE 90.0-0.6mm	TA4070-NS16A
HEAD GASKET KA24DE 90.0-1.0mm	TA4070-NS16B
HEAD GASKET KA24DE 90.0-1.2mm	TA4070-NS16C
HEAD GASKET KA24DE 90.0-1.5mm	TA4070-NS16D

Forced induction greatly increases the combustion pressure, which often causes stock head gaskets to 'blow'. To avoid this, choose a head gasket to suit your setup/desired CR.



CAMSHAFTS	
PONCAM KA24DE IN 270-9.8mm	TA301C-NS16A
PONCAM KA24DE EX 270-9.8mm	TA301E-NS16A

Installing longer duration camshafts helps increase exhaust pressure. This allows the turbo to spool faster, improving both response as well as peak power output.



VALVE SPRINGS	
VALVE SPRING KA24DE	TA301C-NS16A

To take full advantage of using high lift, longer duration camshafts, the valve springs should also be upgraded. These springs help ensure the precise actuation of the valve springs in relation to the camshaft profile.



FUEL PUMP	
FUEL PUMP 255L/H	DISCONTINUED

Injector capacity \times No. of cylinders \times 0.06 = Flow rate req.
With longevity in mind, ensure you choose a fuel pump that will be operating at around 80~90% capacity.



FUEL PRESSURE REGULATOR	
FUEL PRESSURE REGULATOR TYPE-S	TB507A-0000A

The fuel pressure will also need to be adjusted to match the fuel pump.

The initial pressure is set at 3kg/cm².



FUEL PRESSURE GAUGE	
FUEL PRESSURE GAUGE	TB510A-0000A

This is needed to measure fuel pressure.



TURBINE OUTLET PIPE	
TURBINE OUTLET PIPE KIT EXTREME SR20DET	TB6020-NS08C

Turbocharging or converting to a SR20DET turbo layout will require a turbo outlet/elbow to be installed. Installing a large, high flow unit improves turbo spool and response as well as helping to deliver stable boost.



CAT STRAIGHT PIPE	
CAT STRAIGHT PIPE KIT EXTREME Ti FULL TITANIUM NISSAN TYPE-A	TB6100-NS00A

Turbocharging or converting to a SR20DET turbo layout will require the stock catalytic converter to be replaced.

Installing this item will remove the restrictive catalytic converter, allowing for even more power to be made.

※ Competition use *only*



EXHAUST	
MUFFLER KIT EXTREME Ti FULL TITANIUM S14 SR20DET	TB6090-NS08B

Turbocharging or converting to a SR20DET turbo layout will require the exhaust to be replaced. Like the outlet/elbow, installing a large, high flow exhaust improves turbo spool and response as well as top end power.

8.3.2. OTHER PARTS

DOWN PIPE	
Turbocharging or converting to a SR20DET turbo layout will require a down pipe to be installed. Choose one that best suits the vehicle's setup and/or intended use.	
INJECTORS	
Target BHP $\times 5.9 \div$ No. of cylinders = Required injector flow rate (per cylinder) To ensure consistent fuel atomization, injectors ideally need to operate at around 80~90% capacity.	
FUEL RAIL	
The fuel rail may need to be replaced/upgraded depending on injector type and/or size.	
ECU	Must be usable <i>without</i> MAF.
An ECU will need to be installed and mapped to suit the setup.	
(ENGINE) WIRING HARNESS	
An aftermarket harness may need to be installed to suite the new setup. The TOMEI USA 240SX uses a Wiring Specialties S14 KA24DE OEM replacement harness, compatible with: 1995-1996 240sx USDM Manual 1995-1996 240sx USDM Automatic 1995-1996 240sx USDM Automatic, converted to Manual Link: http://www.wiringspecialties.com/s14-ka24de-parts/	
BOOST CONTROLLER	
A boost controller is needed to adjust boost settings.	
BOOST GAUGE	
A boost gauge is required in order to monitor boost levels.	
A/F METER	
An A/F meter will allow you to monitor the A/F ratio.	
DATA LOGGER	
A data logger collects various engine data which can then be used for optimizing the setup.	

8.3.3. OPTIONAL PARTS DEPENDING ON SETUP

<ul style="list-style-type: none"> ■ FORGED PISTONS ■ PERFORMANCE CONNECTING RODS ■ SPARK PLUGS ■ RADIATOR ■ OIL COOLER 	<p>These parts may need upgrading/replacing depending on the engine power, boost levels and/or intended vehicle use. Always use, high performance upgrades/replacements where possible.</p>
--	---

9. TOMEI 240SX KA24DET SPECIFICATIONS



BORE × STROKE	89.5mm × 96.0mm
DISPLACEMENT	2414.8cc
COMPRESSION RATIO	9.0:1
BOOST	1.0kg/cm ²

PISTONS	TOMEI PROTOTYPE 89.5mm
CONNECTING RODS	TOMEI PROTOTYPE
CRANKSHAFT	NISSAN STD
MAIN BEARINGS	NISSAN STD
CONNECTING ROD BEARINGS	NISSAN STD
HEAD GASKET	TOMEI 90.0-1.0mm
IN CAMSHAFT	TOMEI 270-9.8mm
EX CAMSHAFT	TOMEI 270-9.8mm
CAM SPROCKETS	NISSAN STD
VALVES	NISSAN STD
VALVE SPRINGS	TOMEI
VALVE SPRING RETAINERS	NISSAN STD
HEAD STUDS	ARP 202-4304
TURBOCHARGER	TOMEI ARMS M8270
INJECTORS	INJECTOR DYNAMICS 725-48-14
FUEL RAIL	RADIUM 20-0157
FUEL PUMP	TOMEI UNIVERSAL 255L/h
FUEL PRESSURE REGULATOR	TOMEI TYPE-S
FUEL PRESSURE GAUGE	TOMEI
SPARK PLUGS	DENSO IK24
SPARK PLUG WIRES	CUSTOM MADE ULTRA BLUE POINT POWER PLUG WIRES
ECU	HALTECH PLATINUM SPORTS 1000
ENGINE/WIRING HARNESS	WIRING SPECIALTIES
DATA LOGGER/DASH DISPLAY	RACEPAK IQ3

A/F METER	PLX DM-6
INTERCOOLER	GREDDY SPEC-LS TYPE-24E
INTERCOOLER PIPING	TOMEI
THROTTLE BODY	NISSAN STD
INTAKE MANIFOLD	NISSAN STD
RADIATOR	KOYO 1751
RADIATOR HOSE	CIRCUIT SPORTS / MEGAN RACING
THERMOSTAT	NISSAN STD
AIR INTAKE	GREDDY SUCTION KIT Φ 80 (w/o MAF)
EXHAUST MANIFOLD	TOMEI EXPREME
TURBO OUTLET/ELBOW	TOMEI EXPREME TURBO OUTLET for SR20DET
DOWN PIPE	TOMEI PROTOTYPE
CATALYTIC CONVERTER	TOMEI EXPREME TI STRAIGHT NISSAN TYPE-A
EXHAUST	TOMEI EXPREME TI for SR20DET S14
ENGINE OIL	WAKO'S 4CR
FUEL	100 OCTANE

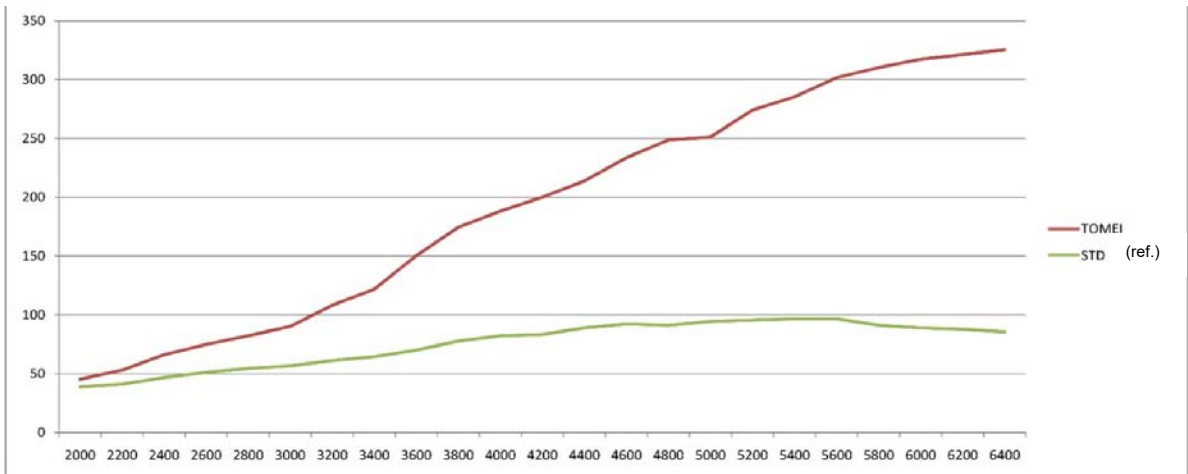



27 Rancho Cir, Lake Forest, CA 92630 USA
Phone : +1-949-855-6577

www.tomeiusa.com

OPEN : Monday-Friday
(National holidays and public holidays excluded)
10:00 - 19:00 PST

TOMEI 取扱説明書 *The Engine Specialist* INSTALLATION MANUAL



マルチレートビレットアクチュエーター MULTI-RATE BILLET ACTUATOR

目次 / INDEX

P2 日本語

P12 English

このたびは弊社製品をお買い上げいただき、まことにありがとうございます。
ご使用前にこの説明書をよくお読みのうえ正しくお使いください。
お読みになった後もすぐ取り出せる場所に大切に保管してください。
説明書に書かれている注意事項は必ず守ってください。
各自動車メーカーの発行する整備要領書が必要になります。本書と合わせて
お使いください。
不適切な使用により事故が生じた場合、弊社では責任を負いかねますので、
あらかじめご了承ください。

Thank you for purchasing a TOMEI product.
Please read this installation manual carefully prior to installation/use.
Ensure you keep this document stored in a safe location for future reference.
Pay close attention to and adhere to the various warnings/cautions contained herein.
You should also consult the official servicing manual for your vehicle when installing
this product.
Please note that inappropriate installation/use of this product will be at the owner's
own risk and/or responsibility.
Retailers/Workshops should ensure this document is given to the end user.

品番 PART NUMBER	適合ターボチャージャーキット			初期設定圧 (kgf/cm ²)	セット スプリング
	エンジン	サイズ	品番		
TB401B-ACT10	RB26DETT	MX7655	TB401A-NS05A	1.00	銀 / 紫
		BX7655	TB403A-NS05A		
		MX8260	TB401A-NS05B		
		BX8260	TB403A-NS05B		
TB401B-ACT07	RB25DET	MX8265	TB401A-NS06A	1.00	銀 / 紫
		BX8265	TB403A-NS06A		
TB401B-ACT09	SR20DET	MX7960	TB401A-NS08A	1.00	銀 / 紫
		BX7960	TB403A-NS08A		
		MX8270	TB401A-NS08B		
		BX8270	TB403A-NS08B		
	KA24DE	MX7960	TB401A-NS16C		
		BX7960	TB403A-NS16C		
		MX8270	TB401A-NS16D		
		BX8270	TB403A-NS16D		
TB401B-ACT13	EJ SINGLE SCROLL	MX7760	TB401A-SB01A	1.00	銀 / 紫
		BX7760	TB403A-SB01A		
		MX7960	TB401A-SB01B		
		BX7960	TB403A-SB01B		
		MX8265	TB401A-SB01C		
		BX8265	TB403A-SB01C		
TB401B-ACT14		MX7960F	TB401A-SB01D	1.00	銀 / 紫
		BX7960F	TB403A-SB01D		
TB401B-ACT12	4G63 EVO4-9	MX7960	TB401A-MT01A	1.00	銀 / 紫
		BX7960	TB403A-MT01A		
		MX7967	TB401A-MT01B		
		BX7967	TB403A-MT01B		
TB401B-ACT11	4B11	MX8280	TB401A-MT02A	1.00	銀 / 紫
		BX8280	TB403A-MT02A		
TB401B-ACT08	1JZ-GTE	MX8280	TB401A-TY04A	1.00	銀 / 紫
		BX8280	TB403A-TY04A		
TB401B-ACT15	G4KF	MX7960	TB401A-HY01A	1.00	銀 / 紫
		BX7960	TB403A-HY01A		



注意

- 本取扱説明書は製品に関わる特記事項についてのみ記載しています。実際の作業や手順については各自動車メーカー発行の整備要領書などを併用してください。
- 本製品は自動車競技部品です。サーキットなどの公道ではない閉鎖された場所で使用してください。
- 本製品を取り付け、調整することにより、エンジン出力が向上する場合があります。そのため、エンジン制御やその他周辺装置の最適化が必要になります。
- ターボメーターなどで常にコンディションの確認をしてください。



警告

- 適合する車種以外へのご使用はおやめください。本製品および、ターボチャージャーやエンジンを破損する恐れがあります。
- 本製品の取り付けは設備の整った環境で、資格をもった整備士が行ってください。
- 本製品を取り付ける際には、適切な工具、保護具を使用してください。ご使用にならないとけがにつながり危険です。
- 本製品の取り付けはエンジンが十分に冷えた状態で行ってください。エンジンが冷えていない状態の作業は火傷の恐れがあります。
- 本製品の取り付けに必要な各部品の脱着の際には指定トルクなどを守り、無理な力を加えないでください。本製品および、ターボチャージャーやエンジンを破損する恐れがあります。

取付/調整作業に必要な工具類

- エンジン整備工具一式
- 整備要領書

製品構成

下記の部品・数量が揃っているかご確認ください。



上記アクチュエーター本体は参考図となります。機種によって形状は異なります。

部品番号	名称	品番	数量
①	アクチュエーター本体	P2参照	1
②	ストレートニップル	TB401B-SAN01	1
③	アクチュエーター Springs 黒	TB401B-SPR07	1
④	アクチュエーター Springs 銀	TB401B-SPR08	1
⑤	アクチュエーター Springs 紫	TB401B-SPR09	1
⑥	アクチュエーター Springs 赤	TB401B-SPR10	1
⑦	アクチュエーター Springs ピンク	TB401B-SPR11	1
⑧	アクチュエーター Springs 青	TB401B-SPR12	1



アクチュエーター Springs セット Springs とスペア Springs について

- アクチュエーター本体にはアクチュエーター Springs が2本セットされています (セット Springs P2参照)。
そのため同梱されている Springs 単体 (スペア Springs) は上記製品構成からセットされている Springs を抜いたものになります。
(セット Springs) + (スペア Springs) = 6本 となります。



アクチュエーター Springs の選択について

本書に記載の各 Springs の単体/設定圧力はアクチュエーター単体で2mmのプリロードをかけた状態でインゲバルブが開き始める圧力となっています。
実際の過給圧の設定は1次排圧の影響や他の部品の仕様により大きく異なる場合があります。過給圧の決定はブーストコントローラーを併用のうえ、実走に等しい環境で確認しながら慎重に行ってください。

1.プリロード調整とターボチャージャーへの取り付け

！ 注意

- 本書の解説は車両からターボチャージャーが取り外されていること、ターボチャージャーからアクチュエーターが取り外されていることを前提としています。車両/ターボチャージャーからの取り外しや、車両への復帰はターボチャージャーの取扱説明書や整備要領書を参照してください。
- 本製品はターボチャージャーキットの補修部品として設定しております。アクチュエーター脱着の際は取り付けボルトやRクリップ、Eリングなどはターボチャージャーキットで使用していたものを再使用しますので、作業の際に無くさないようにご注意ください。

1-1. ターボチャージャーへの取り付け

ターボチャージャーキットから取り外したアクチュエーター取り付けボルトを再使用して取り付けます。
1-2で解説するプリロードを調整したあと、RクリップまたはEリングを使用してターボチャージャーのシングバルブブラケットにロッドを固定し、最後にロッドナットを締め付けます。

1-2. プリロード調整

本製品はターボチャージャー装着時に2mmのプリロードをロッドにかけるように設計されております。プリロードが正しくかかっていることを確認しながら取り付けてください。

調製例

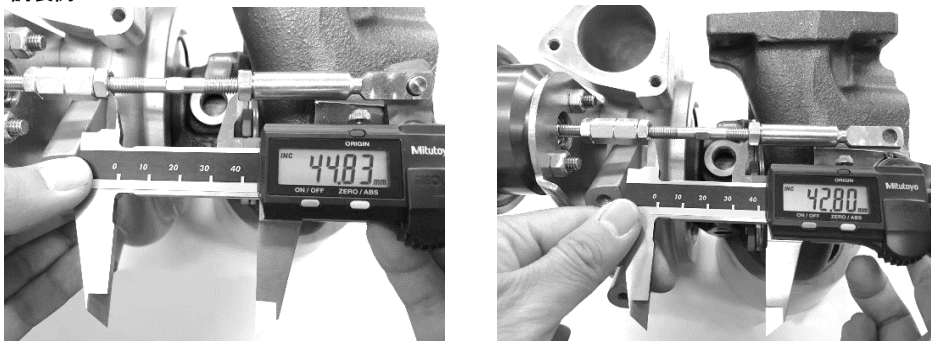

- ① アクチュエーター本体をターボチャージャーに取り付けてください。
- ② アクチュエーターロッドを調整し、ターボチャージャーのシングバルブブラケットと接続してください。
※ このとき、ターボチャージャーのシングバルブがしっかりと閉じていることを確認してください。
- ③ ②の状態アクチュエーターロッドの任意の場所の長さを測ってください。
- ④ アクチュエーターロッドをシングバルブブラケットから外し、ロッドの長さを③で測った長さより2.00~2.25mm程度短くなるように調整してください。

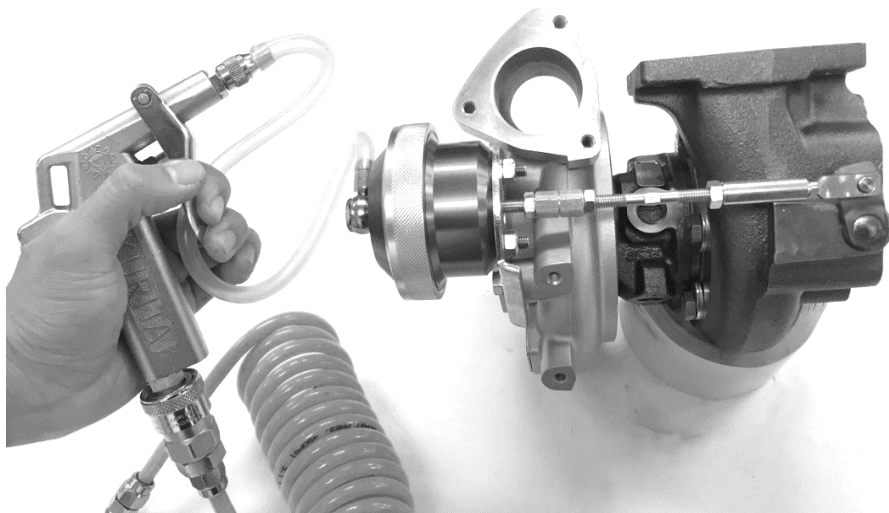

- ⑤ アクチュエータにセットされたスプリングよりも少し高めの圧力をかけてください。圧力をかけるとアクチュエーターロッドが動いてスイングバルブブラケットと接続できるようになります。

! 3kgf/cm²以上の圧力はかけないようにご注意ください。

- ⑥ RクリップまたはEリングを使用してターボチャージャーのスイングバルブブラケットにアクチュエーターロッドを固定してください。
- ⑦ アクチュエーターロッドのナットを締め付けてください。

2.目標ブースト圧の設定（アクチュエータースプリングの交換方法）

本製品はアクチュエータースプリングを最大3つまで組み合わせることにより、ブースト設定値を変更することができます。下記を参考に目的に合ったアクチュエータースプリングを選択してください。スプリングには識別色がついていますが、色がわかりづらい場合は下記のサイズで区別してください。なお、スプリングは最低希望ブースト圧に合わせて選択してください。

スプリング 単体圧力	kgf/cm ²	0.20	0.4	0.6	0.9	0.65	0.75
	Kpa	19.61	39.23	58.84	88.26	63.74	73.55
	PSI	2.84	5.69	8.53	12.80	9.25	10.67
設置位置		インナー	インナー	ミドル	ミドル	アウター	アウター
品番		TB401B -SPR07	TB401B -SPR08	TB401B -SPR09	TB401B -SPR10	TB401B -SPR11	TB401B -SPR12
識別色		黒	銀	紫	赤	ピンク	青
サイズ	外径 mm	29	29	36.5	36.5	44	44
	長さ mm	32	36	43	52	57	68
設定圧力							
kgf/cm ²	Kpa	PSI					
0.20	19.61	2.84	0.20				
0.40	39.23	5.69		0.40			
0.60	58.84	8.53			0.60		
0.65	63.74	9.25				0.65	
0.75	73.55	10.67					0.75
0.80	78.45	11.38	0.20		0.60		
0.85	83.36	12.09	0.20			0.65	
0.90	88.26	12.80				0.90	
0.95	93.16	13.51	0.20				0.75
1.00	98.07	14.22		0.40	0.60		
1.05	102.97	14.93		0.40		0.65	
1.10	107.87	15.65	0.20			0.90	
1.15	112.78	16.36		0.40			0.75
1.25	122.58	17.78			0.60	0.65	
1.30	127.49	18.49		0.40		0.90	
1.35	132.39	19.20			0.60		0.75
1.45	142.20	20.62	0.20		0.60	0.65	
1.55	152.00	22.05	0.20		0.60		0.75
1.55	152.00	22.05				0.90	0.65
1.65	161.81	23.47		0.40	0.60	0.65	
1.65	161.81	23.47				0.90	0.75
1.75	171.62	24.89	0.20			0.90	0.65
1.75	171.62	24.89		0.40	0.60		0.75
1.85	181.42	26.31	0.20			0.90	0.75
1.95	191.23	27.74		0.40		0.90	0.65
2.05	201.04	29.16		0.40		0.90	0.75

※ 上記の設定値はあくまでも目安です。ブースト値は車両の仕様により変化します。

※ 実際のブースト値の設定はブーストコントローラーを併用してください。ブーストコントローラーの設定を主とし、アクチュエーターを補助として調整することで、安定したブーストセッティングが可能となります。

2-1. アクチュエーターの分解

- ① ターボチャージャーからアクチュエーターを取り外してください。



このとき、アクチュエーターロッドとターボチャージャーのスイングバルブブラケットを固定しているRクリップやEリングを紛失しないように注意してください。

RクリップやEリングは再使用します。

- ② アクチュエーターからステータを取り外してください。
- ③ スイベルニップルを外してください。
- ④ アクチュエーターロッドのクレビスとロッドナットを外してください。

アクチュエーターロッドを外せる機種はロッドごと外してください。
作業がしやすくなります。

- ④ アクチュエーターケースをバイス（万力）などで押さえつけてください。
それによりケース/ロックリングへのスプリングの反力が無くなり、ケースを分解することができます。



ロックリングを外す際の注意

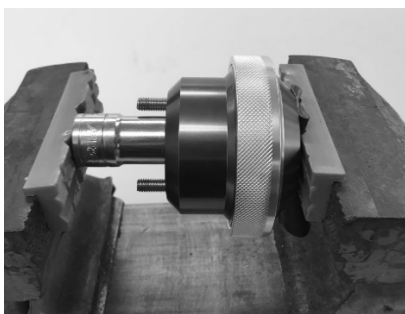

ロッドが外せる機種の場合の一例



ロッドが外せない機種の場合の一例

なるべくケースの中心に均等に圧力がかかるようにバイス（万力）以外のツールも使用して締め付けてください。

この際、必要以上の力で締め付けしないでください。ケースを破損する恐れがあります。
また、アクチュエーターケースが傷つかないように保護をしてください。



ケースに合いマークを入れてください

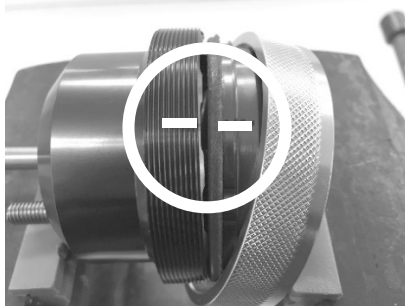

アッパーケースとロアケースの任意の場所に
合いマークを入れてください。

組み立ての際にロゴの向きをもとに
戻すために必要になります。

⑤ バイス（万力）から外してください。



この際、まだケースにスプリングの反力がかかっているため、慎重に扱ってください。

アクチュエーター分解図

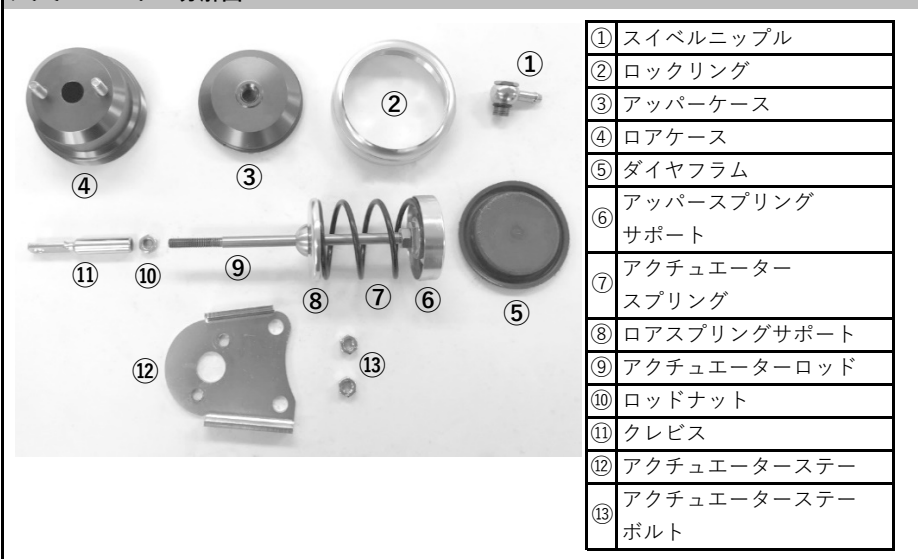

2-2. アクチュエータースプリングの交換



アッパースプリングサポートの裏にはインナー/ミドル/アウター用のスプリングガイドがあります。ここに各スプリングを用途に合わせてセットします。

作業例 初期セットスプリング1.00kgf/cm²を1.55kgf/cm²に変更する



- ① 初期セットスプリングは1.00kgf/cm² (銀/紫) がセットされています。



- ② 0.20kgf/cm² (黒/インナー)
0.60kgf/cm² (紫/ミドル)
0.75kgf/cm² (青/アウター)
に変更します。

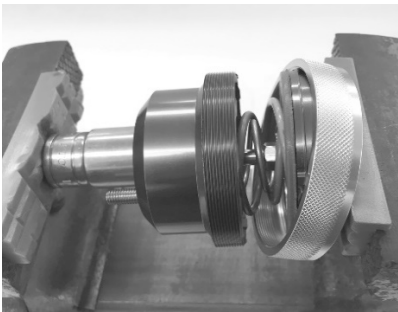

- ③ 本書2-1.アクチュエーターの分解を参考にし、バイス (万力) などでアクチュエータースプリングを縮めてくロックリングで固定してください。



この際、スプリングがスプリングガイドに正しく着座していることを確認しながら締めていってください。

アッパースプリングサポートにダイヤフラムを被せるのを忘れないようにしてください。



ケースを閉じるときの注意



アッパーケース

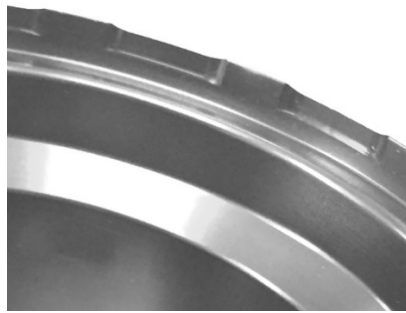

ロアケース

ケースを分解した際につけたアッパーケースとロアケースの合いマークを合わせてください。そうすることでロゴマークが初期の位置になります。また、アッパーケースに3ヶ所、ロアケースに12ヶ所の切り欠きがあります。その切り欠きどうしを合わせて固定してください。

2-3. アクチュエータースプリング選択方法の一例

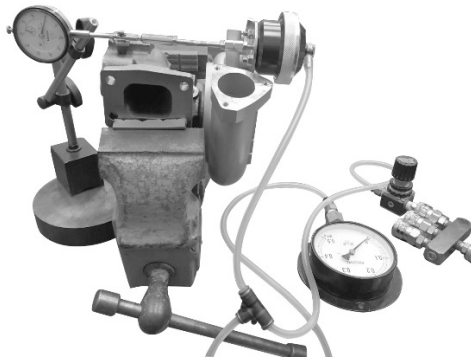

- アクチュエーターを動かさないように固定する。
- 計測器（マイクロメーターなど）アクチュエーターロッドのトラベル量が計測できるようセットする
- 圧力計を通してアクチュエーターにエアを入れる
- 計測器の動きでアクチュエーターの動作圧力を確認する。
- アクチュエータースプリング一覧表を参考に目的にあったスプリングに入れ替える

3. ターボチャージャー/車両への復帰

- これまでに取り外したアクチュエーターロッド/スィベルニップル/アクチュエーターステーなどを元に戻し、ターボチャージャー/車両へと取り付けてください。

P/N	COMPATIBLE TURBOCHARGER KITS			PRESET (kgf/cm ²)	SET SPRINGS
	ENGINE	SIZE	P/N		
TB401B-ACT10	RB26DETT	MX7655	TB401A-NS05A	1.00	SILVER/ PURPLE
		BX7655	TB403A-NS05A		
		MX8260	TB401A-NS05B		
		BX8260	TB403A-NS05B		
TB401B-ACT07	RB25DET	MX8265	TB401A-NS06A	1.00	SILVER/ PURPLE
		BX8265	TB403A-NS06A		
TB401B-ACT09	SR20DET	MX7960	TB401A-NS08A	1.00	SILVER/ PURPLE
		BX7960	TB403A-NS08A		
		MX8270	TB401A-NS08B		
		BX8270	TB403A-NS08B		
	KA24DE	MX7960	TB401A-NS16C		
		BX7960	TB403A-NS16C		
		MX8270	TB401A-NS16D		
		BX8270	TB403A-NS16D		
TB401B-ACT13	EJ SINGLE SCROLL	MX7760	TB401A-SB01A	1.00	SILVER/ PURPLE
		BX7760	TB403A-SB01A		
		MX7960	TB401A-SB01B		
		BX7960	TB403A-SB01B		
		MX8265	TB401A-SB01C		
		BX8265	TB403A-SB01C		
TB401B-ACT14		MX7960F	TB401A-SB01D	1.00	SILVER/ PURPLE
		BX7960F	TB403A-SB01D		
TB401B-ACT12	4G63 EVO4-9	MX7960	TB401A-MT01A	1.00	SILVER/ PURPLE
		BX7960	TB403A-MT01A		
		MX7967	TB401A-MT01B		
		BX7967	TB403A-MT01B		
TB401B-ACT11	4B11	MX8280	TB401A-MT02A	1.00	SILVER/ PURPLE
		BX8280	TB403A-MT02A		
TB401B-ACT08	1JZ-GTE	MX8280	TB401A-TY04A	1.00	SILVER/ PURPLE
		BX8280	TB403A-TY04A		
TB401B-ACT15	G4KF	MX7960	TB401A-HY01A	1.00	SILVER/ PURPLE
		BX7960	TB403A-HY01A		



CAUTION

- This installation manual contains important information regarding this product.
For details regarding the assembly/disassembly of stock components, please refer to the vehicle's official servicing manual.
- This product is intended for motorsport use and should only be used on a racing circuit or a circuit closed off from public roads.
- Installing this product will increase the engine's power output. After installation, the engine management system and other surrounding components will need to be adjusted accordingly.
- Ensure you consistently monitor the turbo's performance using gauges and/or similar devices.



WARNING

- Only install this product on the specified vehicles to avoid damaging the product and/or engine.
- This product should be installed by a trained professional in a well-equipped workshop.
- Ensure you use the appropriate tools and safety gear when installing this product.
Failing to do so may result in injury.
- Install this product only when the engine is cool and/or cold to avoid potential fire hazards.
- Ensure you use the correct specified torque for each fastening. Do not use excessive force when attaching or removing components as this may damage the product and/or engine.

REQUIRED TOOLS FOR INSTALLATION

- General engine maintenance tools
- Official servicing manual

KIT CONTENTS

Check to ensure all the following items are included in this kit.



Depending on the application, the actuator may look different compared to the one above.

REF. NO.	PART	P/N	QTY
①	ACTUATOR	See P2	1
②	STRAIGHT NIPPLE	TB401B-SAN01	1
③	ACTUATOR SPRING, BLACK	TB401B-SPR07	1
④	ACTUATOR SPRING, SILVER	TB401B-SPR08	1
⑤	ACTUATOR SPRING, PURPLE	TB401B-SPR09	1
⑥	ACTUATOR SPRING, RED	TB401B-SPR10	1
⑦	ACTUATOR SPRING, PINK	TB401B-SPR11	1
⑧	ACTUATOR SPRING, BLUE	TB401B-SPR12	1



ACTUATOR SPRINGS: PRESET SPRINGS & SPARE SPRINGS

- The actuator ships preconfigured with 2 springs already inside.
(See P11, SET SPRINGS) .
Besides these 2 springs, there are an additional 4 spare springs.
(SET SPRINGS) + (SPARE SPRINGS) = 6 SPRINGS IN TOTAL



CHOOSING ACTUATOR SPRINGS

The standalone pressure/spring rate of each spring shown in this manual were all measured with 2mm of preload applied. Actual boost pressure will vary depending on pre-turbo exhaust pressure as well as the supporting modifications. Note, boost settings should be made using a boost controller in an accurately simulated driving environment.

1. ADJUSTING PRELOAD AND INSTALLATION

CAUTION

- The following information is based on the turbocharger and actuator being completely removed from the vehicle and separated from one another in advance.
For details on removing and/or reinstalling the turbocharger, please refer to the turbocharger installation manual or the vehicle's official servicing manual.
- This product is a components of the turbocharger kit.
Be careful not to misplace the R and/or E clips when removing the actuator from the turbocharger. These will be reused again later.

1-1. INSTALLING ONTO THE TURBOCHARGER

Reinstall the actuator onto the turbocharger using the actuator bolts.
After adjusting the preload as detailed in 1-2, use the R and/or E clip to re-secure the actuator rod to the wastegate bracket.
Remember to also tighten down the actuator rod nut(s).

1-2. ADJUSTING THE PRELOAD

This actuator is designed to take 2mm of preload when attached to the turbocharger.
Ensure the preload is applied correctly as you proceed with the installation.

調製例

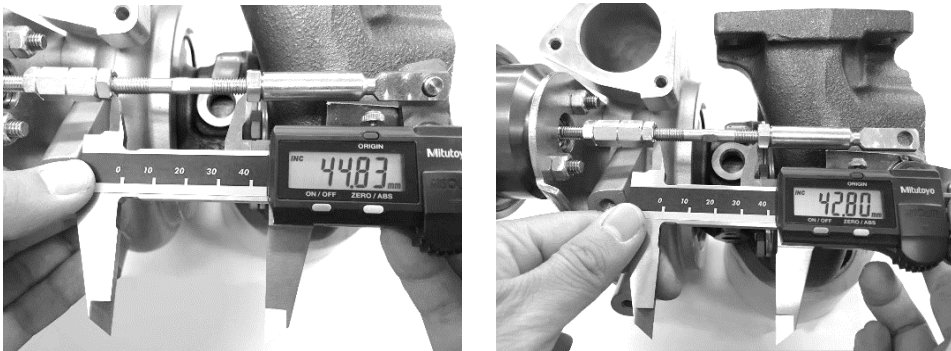

- ① Install the actuator onto the turbocharger.
- ② Adjust and connect the actuator rod to the wastegate bracket.
 - ※ Ensure the wastegate is fully closed during this process.
- ③ Measure the required actuator rod length as set during ②.
- ④ Temporarily remove the actuator rod from the wastegate bracket and shorten the length measured during ③ by 2.00~2.25mm.

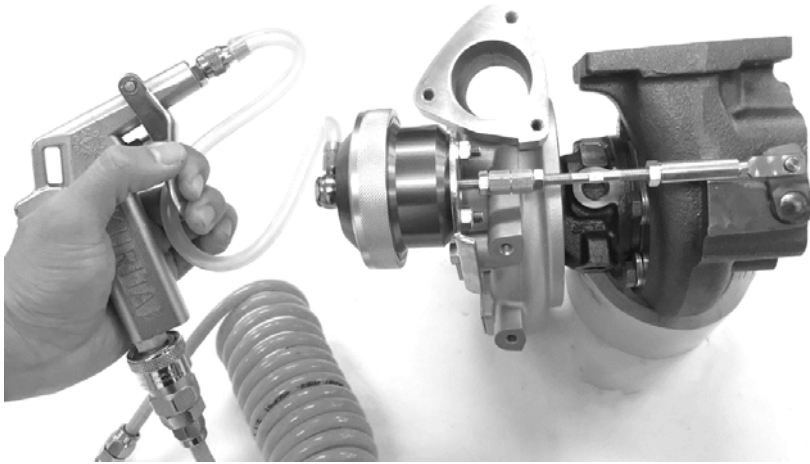

- ⑤ Apply air pressure to the actuator using slightly higher pressure than the configured springs. This will move the actuator rod, allowing you to reconnect it to the wastegate bracket.

 Do not apply more than 3kgf/cm² of pressure.

- ⑥ Secure the actuator rod to the wastegate bracket using the R and/or E clip.
- ⑦ Tighten down the nuts on the actuator rod.

2. SETTING BOOST PRESSURE (CHANGING SPRINGS)

This product features interchangeable actuator springs, allowing you to set different boost pressures by combining up to 3 springs. Use the below information as reference to find the combination for you. All the springs are color coded. However, if you are unsure, use the sizing chart below for reference. Note that spring(s) should be chosen based on the lowest desired boost pressure.

STANDALONE	kgf/cm ²	0.20	0.4	0.6	0.9	0.65	0.75
SPRING	Kpa	19.61	39.23	58.84	88.26	63.74	73.55
PRESSURE	PSI	2.84	5.69	8.53	12.80	9.25	10.67
POSITIONING		INNER	INNER	MIDDLE	MIDDLE	OUTER	OUTER
P/N		TB401B -SPR07	TB401B -SPR08	TB401B -SPR09	TB401B -SPR10	TB401B -SPR11	TB401B -SPR12
COLOR		BLACK	SILVER	PURPLE	RED	PINK	BLUE
SIZE	O.D (mm)	29	29	36.5	36.5	44	44
	LENGTH (mm)	32	36	43	52	57	68
CONFIGURED PRESSURE							
kgf/cm ²	Kpa	PSI					
0.20	19.61	2.84	0.20				
0.40	39.23	5.69		0.40			
0.60	58.84	8.53			0.60		
0.65	63.74	9.25				0.65	
0.75	73.55	10.67					0.75
0.80	78.45	11.38	0.20		0.60		
0.85	83.36	12.09	0.20			0.65	
0.90	88.26	12.80				0.90	
0.95	93.16	13.51	0.20				0.75
1.00	98.07	14.22		0.40	0.60		
1.05	102.97	14.93		0.40		0.65	
1.10	107.87	15.65	0.20			0.90	
1.15	112.78	16.36		0.40			0.75
1.25	122.58	17.78			0.60	0.65	
1.30	127.49	18.49		0.40		0.90	
1.35	132.39	19.20			0.60		0.75
1.45	142.20	20.62	0.20		0.60	0.65	
1.55	152.00	22.05	0.20		0.60		0.75
1.55	152.00	22.05				0.90	0.65
1.65	161.81	23.47		0.40	0.60	0.65	
1.65	161.81	23.47				0.90	0.75
1.75	171.62	24.89	0.20			0.90	0.65
1.75	171.62	24.89		0.40	0.60		0.75
1.85	181.42	26.31	0.20			0.90	0.75
1.95	191.23	27.74		0.40		0.90	0.65
2.05	201.04	29.16		0.40		0.90	0.75

※ The above is for reference only. Actual settings will vary depending on the vehicle specifications.

※ A boost controller should be used in conjunction to accurately adjust boost settings.

For best results, the boost controller should be used as the main boost control device, with the actuator springs providing a secondary level of adjustment.

2-1. DISASSEMBLING THE ACTUATOR

- ① Remove the actuator from the turbocharger.



Be careful not to misplace the R and/or E clips that secure the actuator rod to the wastegate bracket. These will be reused again later.

- ② Remove the actuator bracket from the actuator.
- ③ Remove the swivel nipple.
- ④ Remove the clevis and rod nuts from the actuator rod.
Remove the actuator rod if possible. (Only on some models)
This will make the following steps easier.

- ④ Secure the actuator case using a vice or similar tool.
This will relieve the pressure on the spring(s) and allow you to remove the case/lock ring.



BE CAREFUL WHEN REMOVING THE LOCK RING

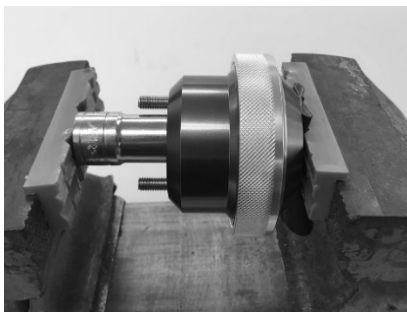

Actuator with removable rod.

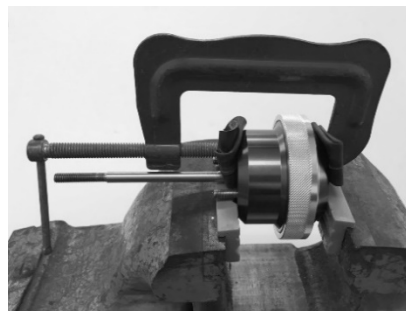

Actuator without removable rod.

Try to apply the clamping force evenly to the actuator casing using additional clamping tools.

Do *not* use excessive force as this may damage the actuator.

Ensure you also protect the actuator casing against scratches.



NOT THE CASING ALIGNMENT

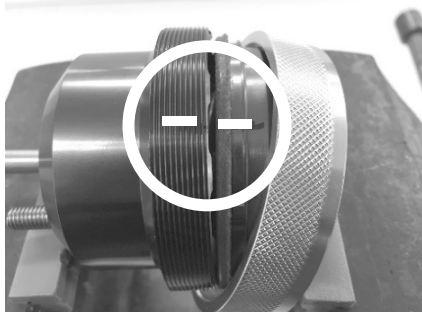

Make note of the alignment of the upper case in relation to the lower case.

This is to ensure the logo is orientated in the same direction during reassembly.

⑤ Remove the actuator from the vice.



Take care during this step as there is still some pressure being applied by the springs.

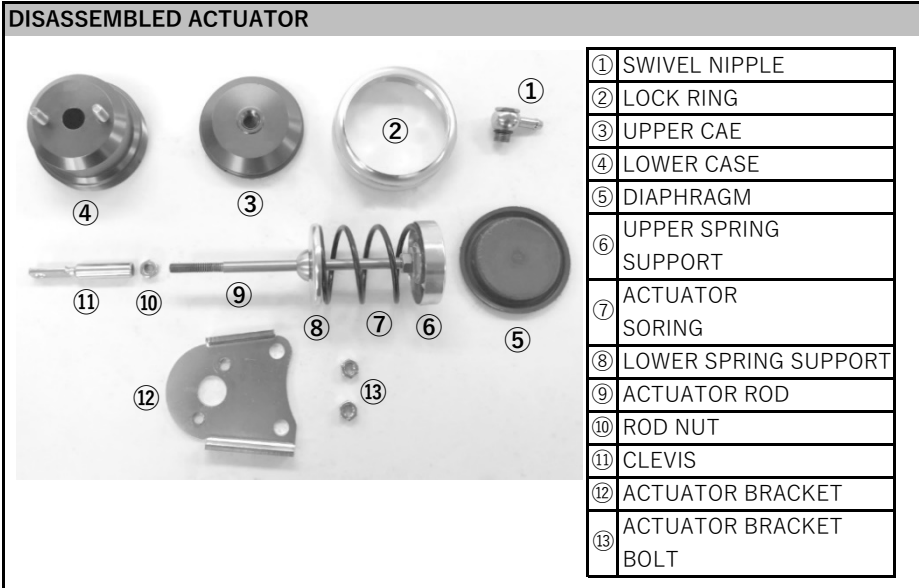

2-2. CHANGING ACTUATOR SPRINGS



The upper spring support is stepped to accommodate the inner, middle and outer springs. Each spring should be seated on their respective step.

EXAMPLE: CHANGING FROM THE INITIAL 1.00kgf/cm² TO 1.55kgf/cm²

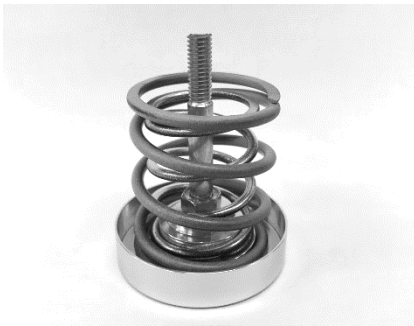

① The initial boost pressure is set at 1.00kgf/cm² (SILVER/PURPLE)



② 0.20kgf/cm² (BLACK/INNER)
0.60kgf/cm² (PURPLE/MIDDLE)
0.75kgf/cm² (BLUE/OUTER)
Now reconfigured to 1.55kgf/cm²

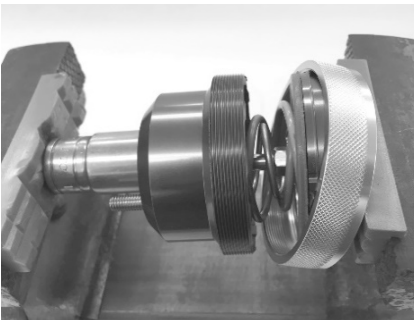

③ Using step 2-1 as reference, clamp and compress the actuator springs in the housing using a vice, then secure using the lock ring.



Ensure the springs are seated correctly before compressing the actuator ASSY.

Remember to also place the diaphragm on top of the upper spring support.



CAUTION WHEN CLOSING THE CASING



UPPER CASE

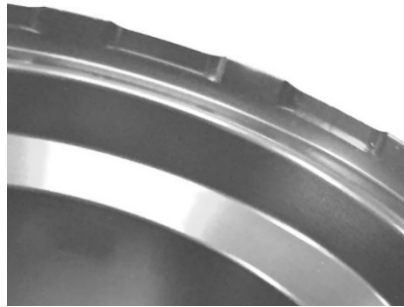

LOWER CASE

Ensure you align the upper and lower casings according to the alignment marks made earlier. This ensure that the logo is orientated the same as before. Also, there are alignment notches on both the upper (x3) and lower (x12) casings. Make sure these also align when reassembling the actuator.

2-3. HOW TO CHOOSE ACTUATOR SPRINGS (EXAMPLE)



- Clamp/secure the actuator on a stable surface so that it doesn't move.
- Next, set up a dial indicator or similar tool so that you can accurately measure actuator rod travel.
- Using an air compressor and pressure gauge, apply air pressure to the actuator.
- Note the pressure at which the actuator rod begins to move.
- Then, use the following table to choose the appropriate spring(s) for your setup.

3. REINSTALLING ONTO THE TURBOCHARGER/VEHICLE

- Reassemble the actuator rod, swivel nipple and actuator bracket. Then, reinstall onto the turbocharger and/or vehicle



27 Rancho Cir, Lake Forest, CA 92630 USA
Phone : +1-949-855-6577

www.tomeiusa.com

OPEN : Monday-Friday
(National holidays and public holidays excluded)
10:00 - 19:00 PST